

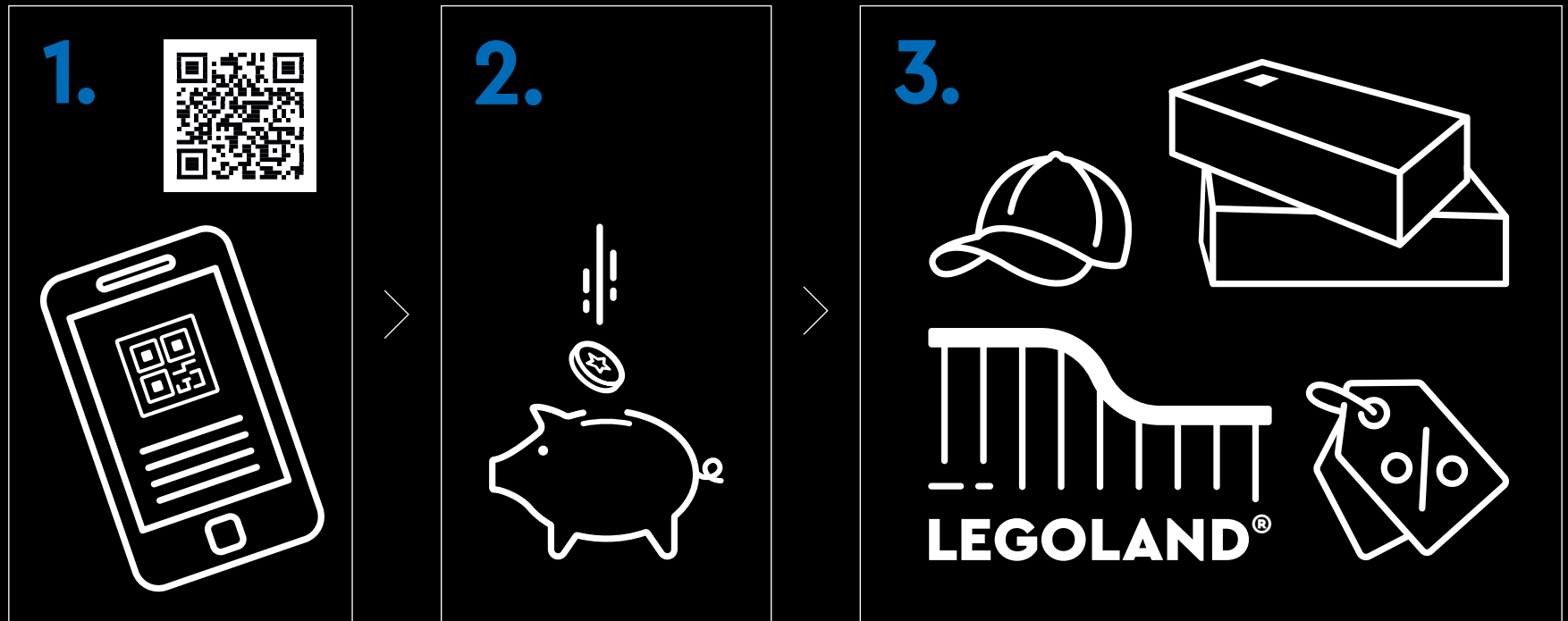



LEGO.com/sustainable-packaging

LEGO® VIP



1. Sign up **2.** Earn points for purchases **3.** Redeem points for rewards, experiences, discounts & more | **1.** Melde dich an **2.** Sammle Punkte bei jedem Kauf **3.** Löse die Punkte für Belohnungen, Erlebnisse, Rabatte und Ähnliches ein | **1.** Inscrivez-vous **2.** Gagnez des points lors de vos achats **3.** Échangez vos points contre des récompenses, des expériences, des remises et bien plus encore | **1.** Iscriviti **2.** Guadagna punti con i tuoi acquisti **3.** Riscatta punti per premi, esperienze, sconti e altro ancora | **1.** Regístrate **2.** Gana puntos por tus compras **3.** Canjea puntos por recompensas, experiencias, descuentos y mucho más | **1.** Registe-se **2.** Ganhe pontos em compras **3.** Troque os pontos para prémios, experiências, descontos e muito mais | **1.** 注册 **2.** 购物赚积分 **3.** 用积分兑换奖励、体验、折扣等 | **1.** Zarejestruj się **2.** Zdobywaj punkty za zakupy **3.** Wymieniaj punkty na rabaty, przygody i inne nagrody | **1.** Zaregistrujte se **2.** Sbírejte body za nákupy **3.** Vyměňujte body za odměny, zážitky, slevy a spoustu dalšího | **1.** Zaregistrujte se **2.** Získavajte body za nákupy **3.** Uplatnite si body a získajte odmeny, rôzne zážitky, zľavy a ešte viac | **1.** Regisztrálj **2.** Szerezz pontokat minden vásárlással **3.** Váltsd be pontjaidat jutalmakra, élményekre, kedvezményekre és egyebekre | **1.** Înscrite-te **2.** Câștigă puncte pentru achiziții **3.** Valorifică puncte pentru recompense, experiențe, reduceri și multe altele | **1.** Регистрируйте се **2.** Получайте точки за покупки **3.** Используйте точки за награды, услуги, отстъпки и т.н. | **1.** Reģistrējies **2.** Pelni punktus par pirkumiem **3.** Izmanto punktus, lai saņemtu balvas, izklaides iespējas, atlaides un daudz ko citu | **1.** Registreeru **2.** Teeni ostude eest punkte **3.** Lunasta punktide eest preemiad, elamused, allahindlused ja muu | **1.** Užsiregistruokite **2.** Pelnykite taškų už pirkinius **3.** Panaudokite taškus atlygiui, funkcijoms, nuolaidoms ir ne tik





BIENVENUE À FONDCOMBE

Vingt ans après la sortie du *Retour du roi*, la spectaculaire trilogie du *Seigneur des Anneaux* reste l'une des œuvres cinématographiques les plus marquantes de notre époque. Il n'est donc pas aisé de choisir sa scène ou son moment préféré. Même en temps de conflits, Fondcombe, la vallée des Elfes, est un lieu prospère et un véritable havre de paix, symbolisant la guérison, l'espoir, le calme et l'union. C'est là que, lors d'un conseil crucial, les représentants des peuples de la Terre du Milieu forgent la *Communauté de l'Anneau* afin de détruire l'Anneau pour les gouverner tous.



La communauté de designers LEGO®

UNE COMMUNAUTÉ DE DESIGNERS LEGO®

Une communauté de créateurs de modèles, d'éléments et de graphismes du monde entier s'est donné pour mission de recréer la magie de ce lieu. Puisant son inspiration dans les plans des studios, l'équipe a pris quelques libertés artistiques en ajoutant ses caractéristiques préférées. Cette reproduction détaillée de l'emblématique Imladris, la Dernière Maison Simple à l'est de la mer, constituée de 6 000 briques LEGO®, regorge de références à la saga et à ses personnages iconiques, le tout à l'échelle des minifigurines LEGO.



SCÈNES CULTE DU SEIGNEUR DES ANNEAUX LEGO®

De l'arrivée de Gandalf le Gris dans la Comté à la bataille finale contre le Roi des Morts sur les rives de Minas Tirith, redécouvrez les scènes emblématiques recréées dans les sets LEGO® *Le Seigneur des Anneaux* sortis en 2012-2013.



9469 L'ARRIVÉE DE GANDALF™

Gandalf le Gris se rend dans la Comté à l'occasion du 111^e anniversaire de son ami Bilbon Sacquet. Il y fait la rencontre du jeune Frodon Sacquet, et l'aventure commence.



79006 LE CONSEIL D'ELROND

Les habitants de la Terre du Milieu sont convoqués au Conseil d'Elrond à Fondcombe. C'est là que sera scellé le destin de l'Anneau unique.



9473 LES MINES DE LA MORIA™

L'héroïque Communauté de l'Anneau affronte les terribles orques de la Moria et un troll des cavernes géant dans le tombeau de Balin, au fin fond des mines abandonnées de la Moria.



9474
LA BATAILLE DU GOUFFRE DE HELM

La forteresse du gouffre de Helm et les habitants du Rohan sont attaqués par l'armée barbare d'Uruk-hai de Saroumane.



10237
LA TOUR D'ORTHANC

Avec ses 2 357 pièces, La tour d'Orthanc était le plus grand set LEGO® Le Seigneur des Anneaux jamais créé au moment de sa sortie. Il comprend 6 étages, emplies de minifigures et scènes emblématiques.



79008
L'EMBUSCADE DU BATEAU PIRATE

Les orques du Mordor de Sauron s'apprêtent à accueillir leurs alliés à bord de leur bateau pirate... mais c'était sans compter sur l'arrivée de Aragorn, Gimli, Legolas et leur Armée des Morts.



LA TOUR

Pendant son séjour à Fondcombe, Bilbon termine son livre *Le Hobbit* sur son bureau dans la Tour. Ce lieu secret situé en bas de la Tour est parfait pour cacher un fugitif ou mettre l'Anneau Unique à l'abri des regards indiscrets.

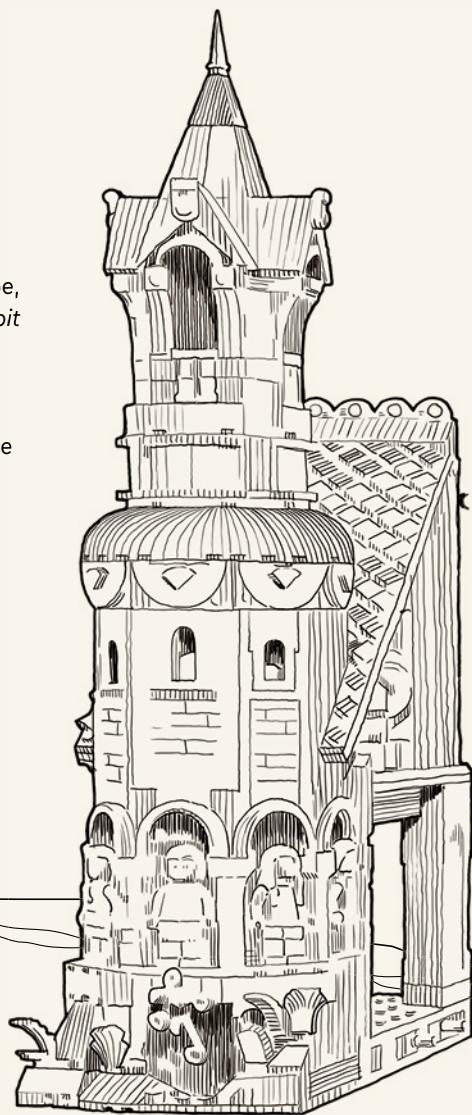

Frodon présente deux jambes moulées, ce qui met en évidence ses pieds nus, un trait caractéristique des Hobbits de la Comté. Il porte également l'Anneau Unique, qu'il a apporté à Fondcombe pour permettre au conseil de décider de son sort.

FRODON SACQUET



Décorée des 2 côtés, la tête de Bilbon présente l'expression effrayante qu'il arbore lorsqu'il essaie de dérober l'Anneau à Frodon.

BILBON SACQUET



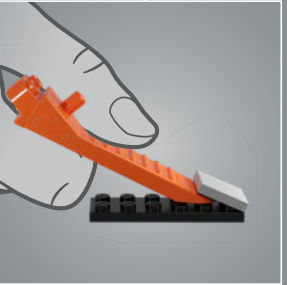
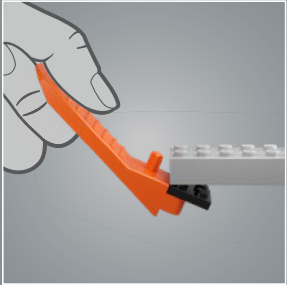
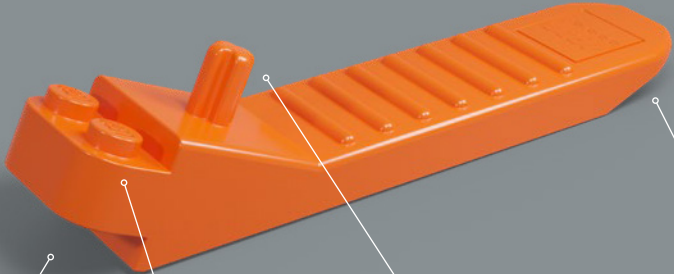

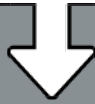

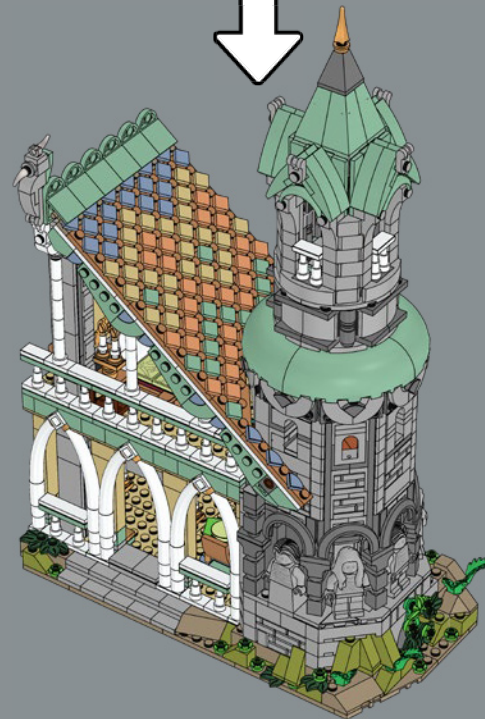
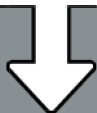

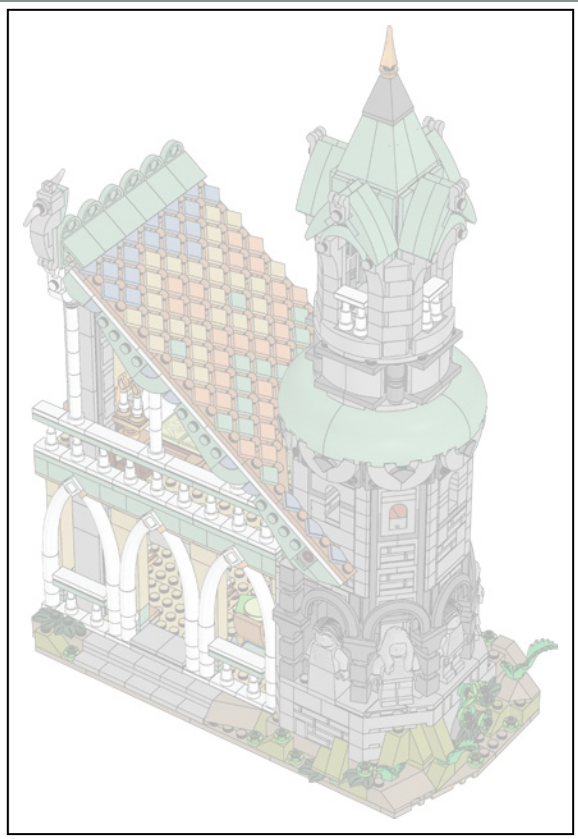

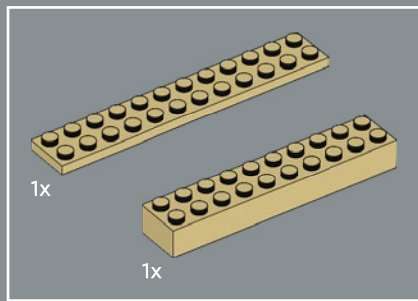

1

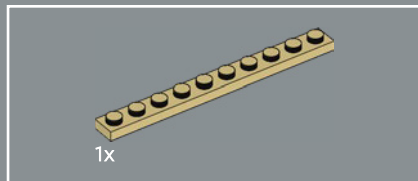
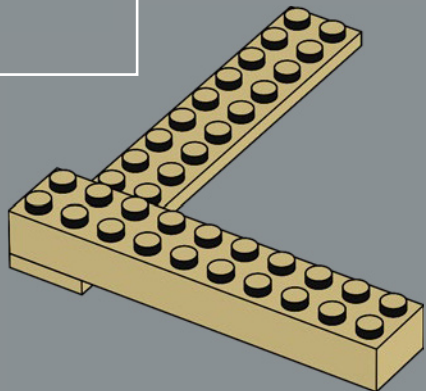

2

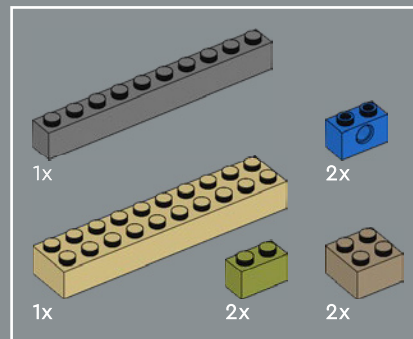
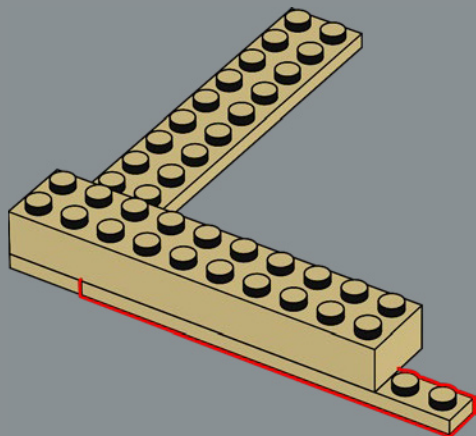

3

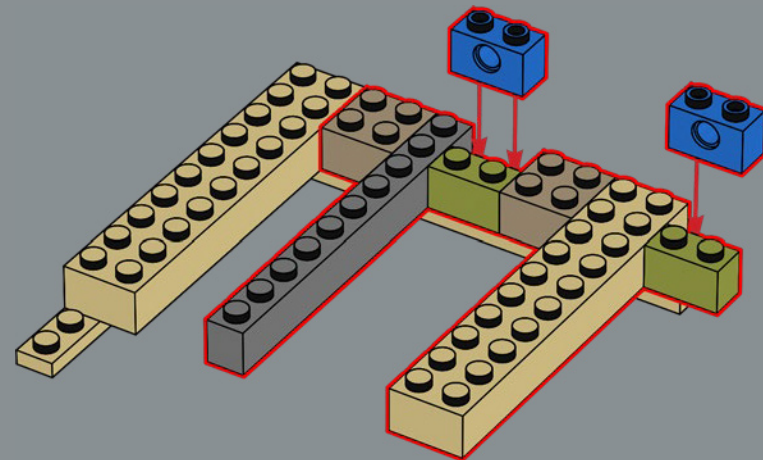

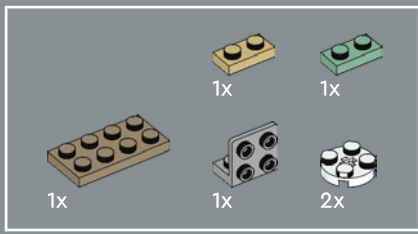

4

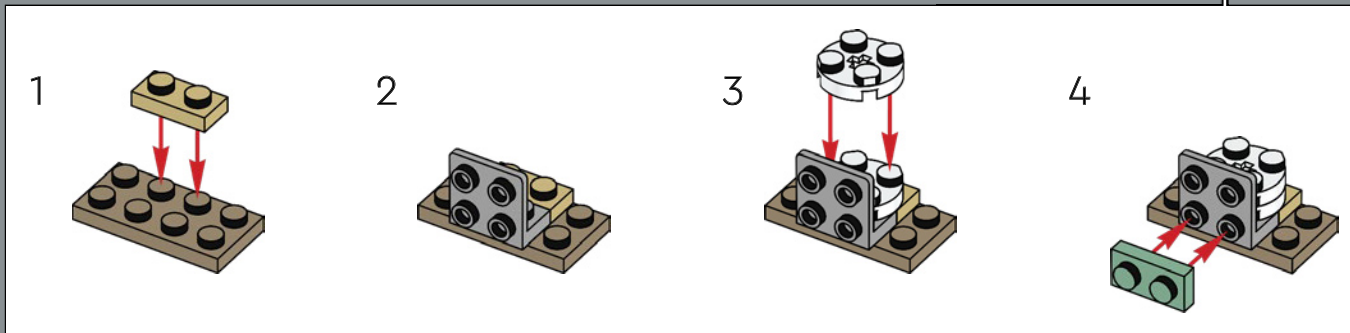
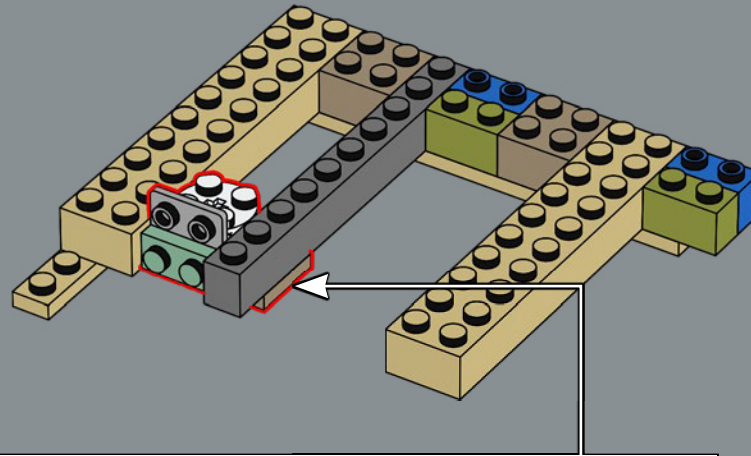

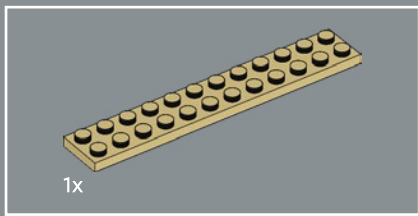

5

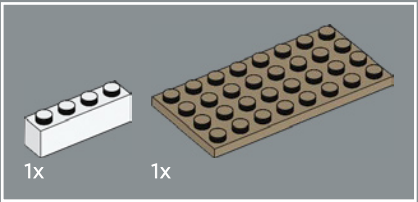
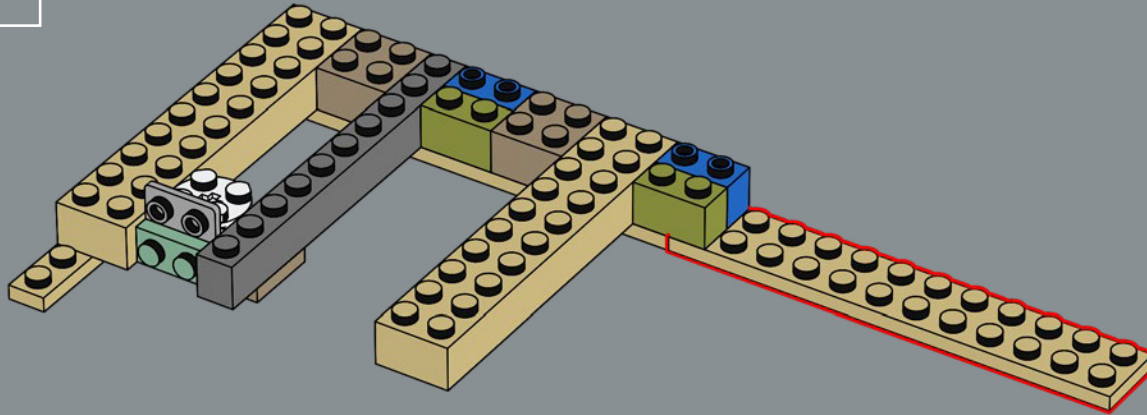

6

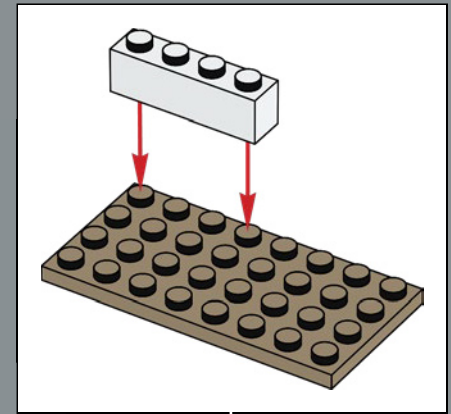
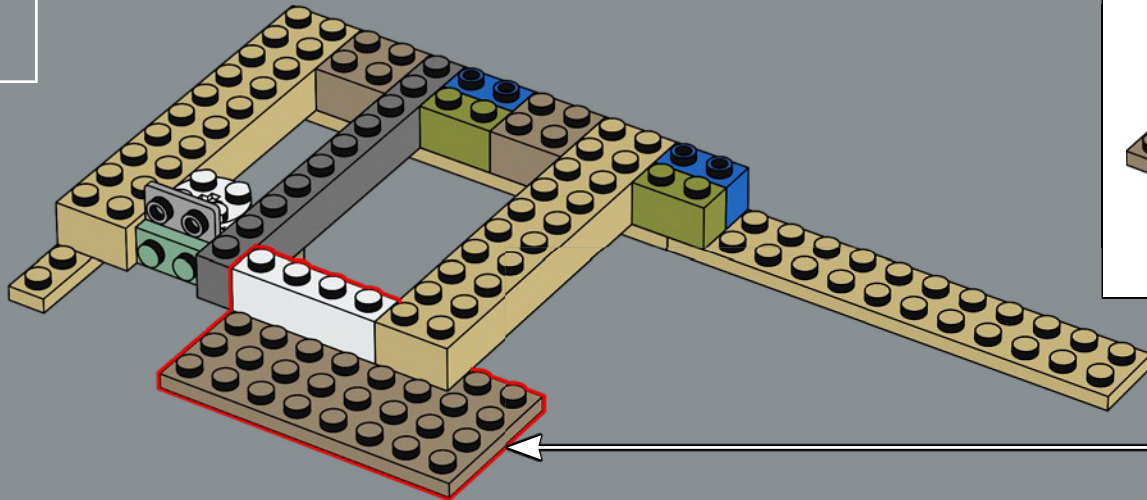

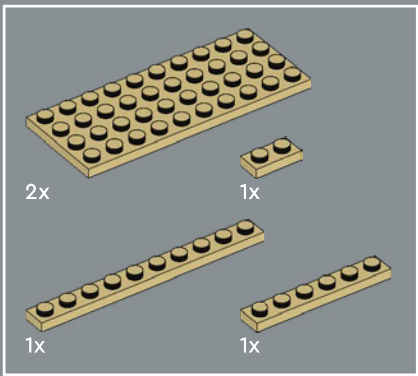

7

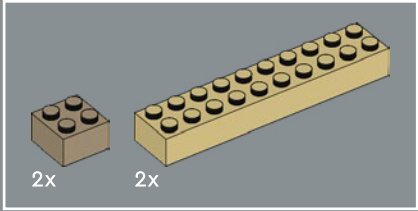
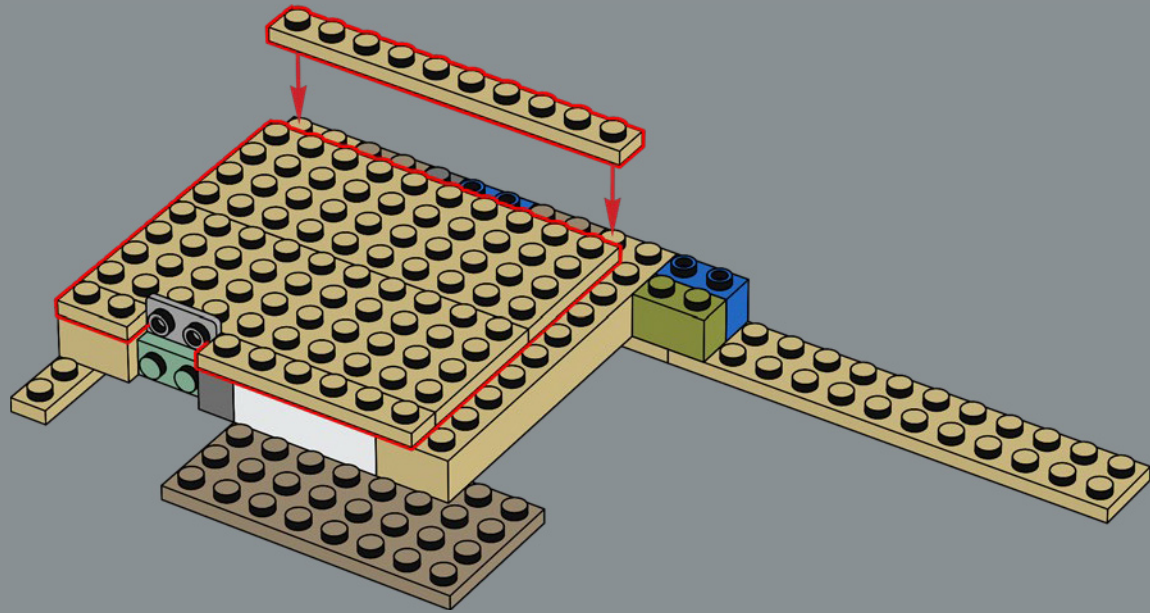

8

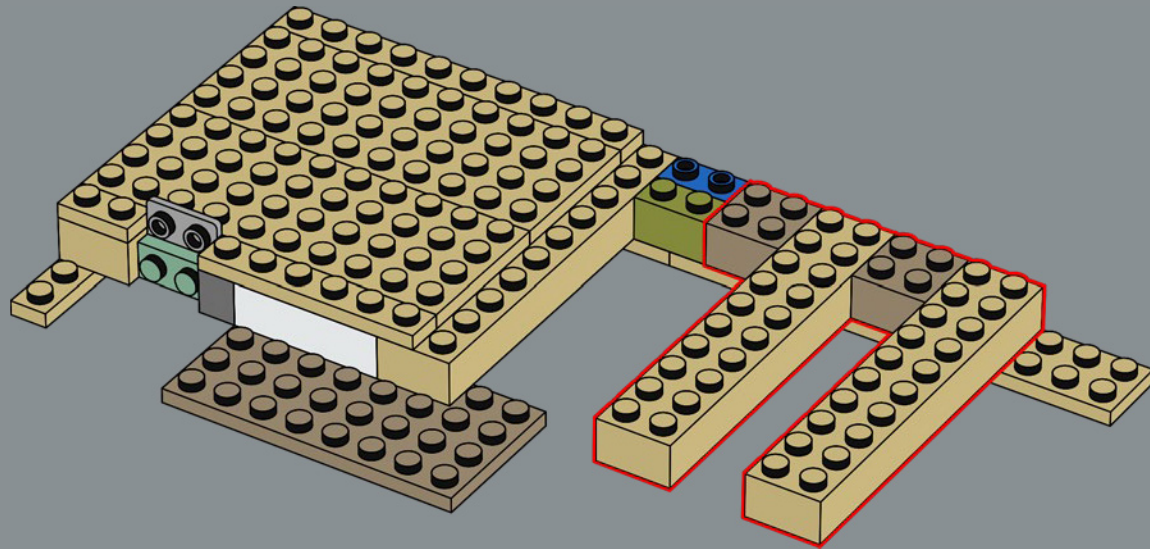

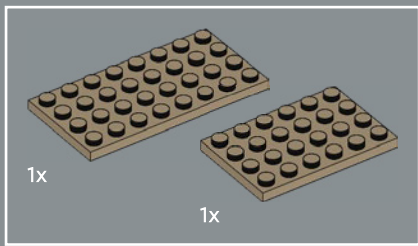

9

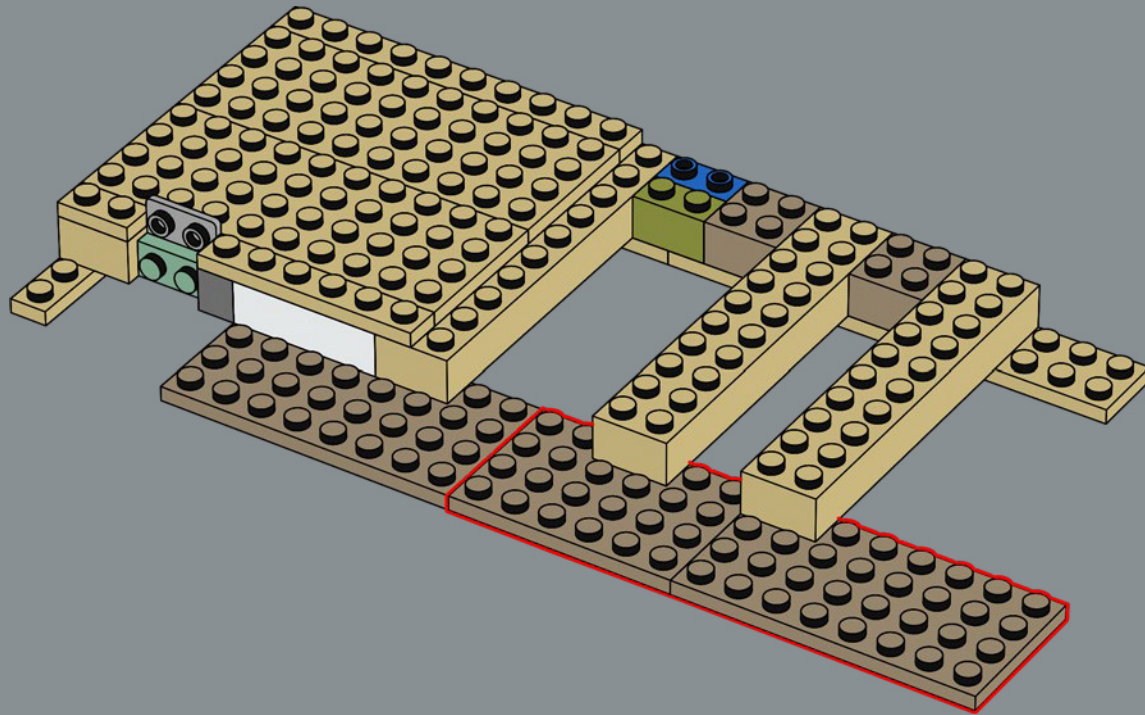

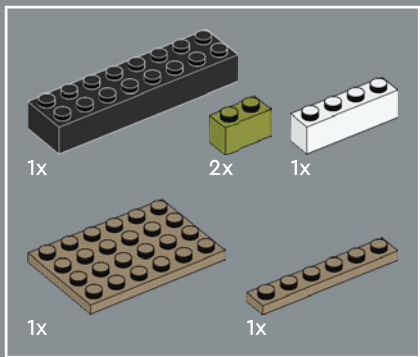

10

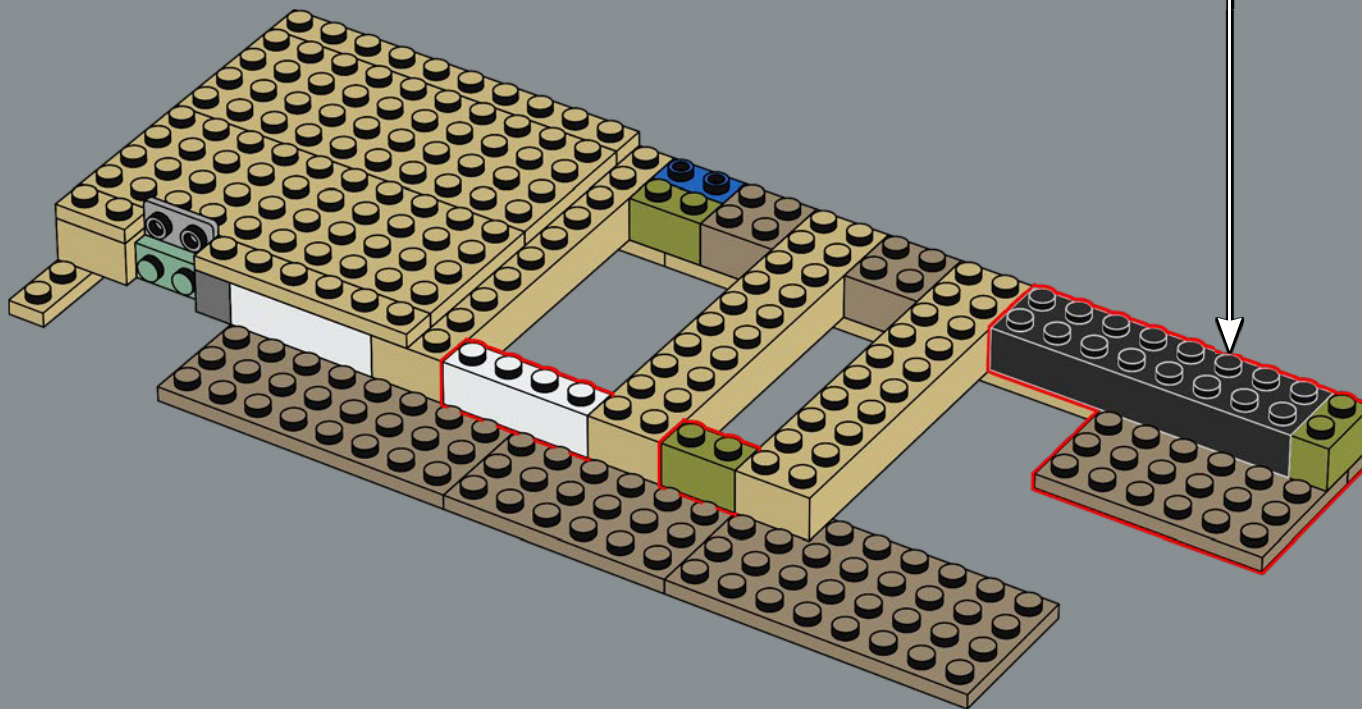
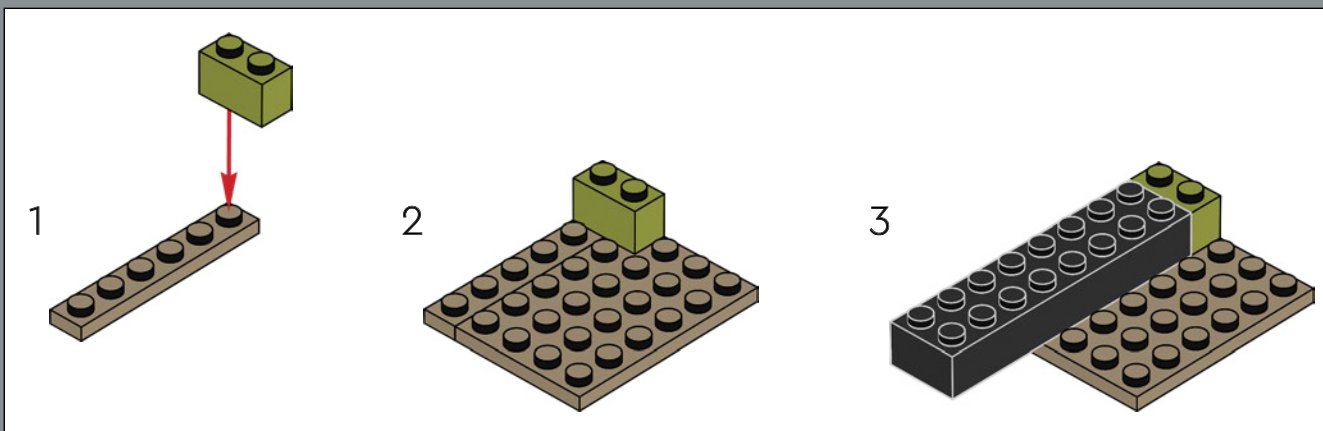

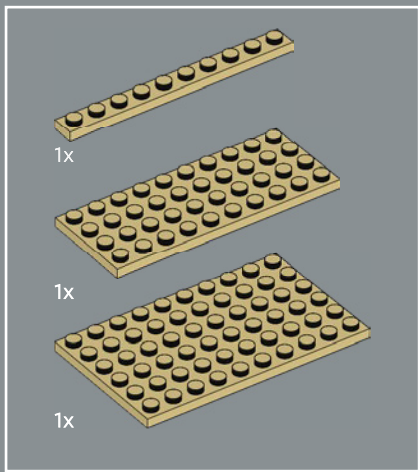

11

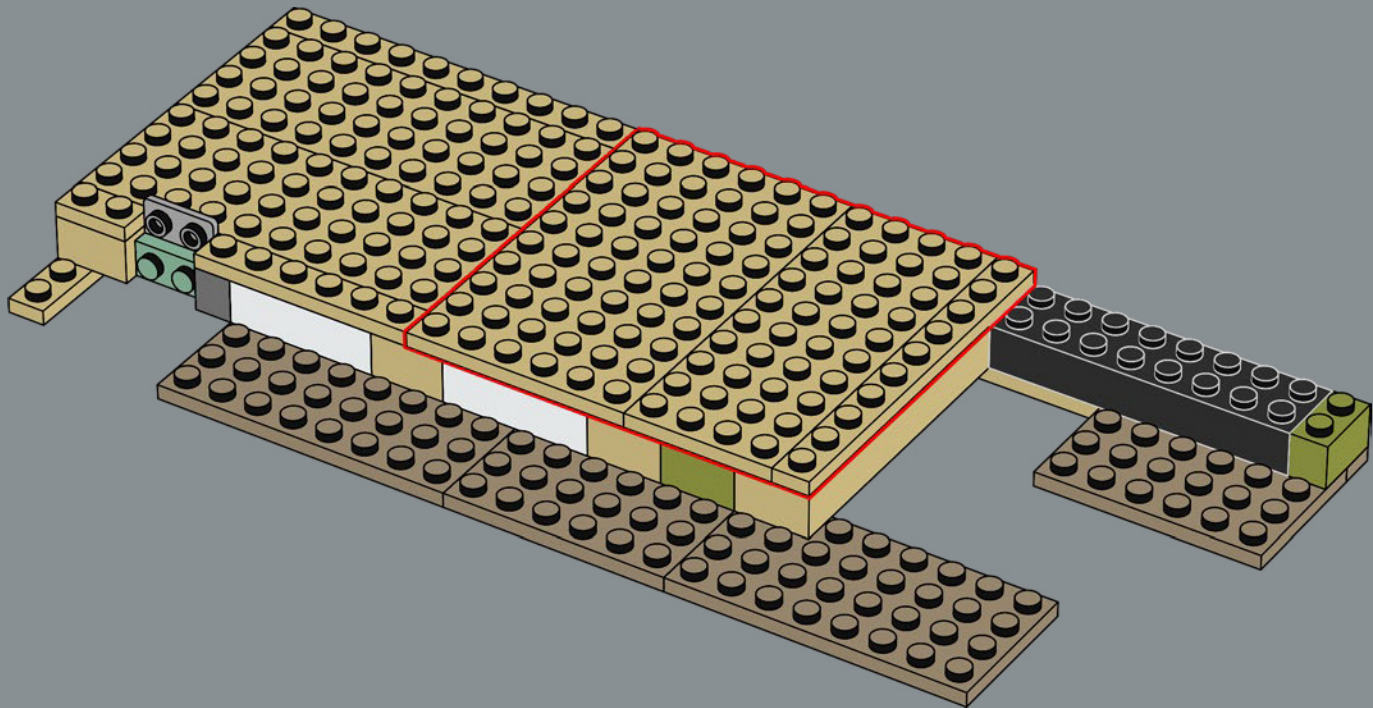

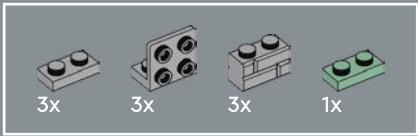

12

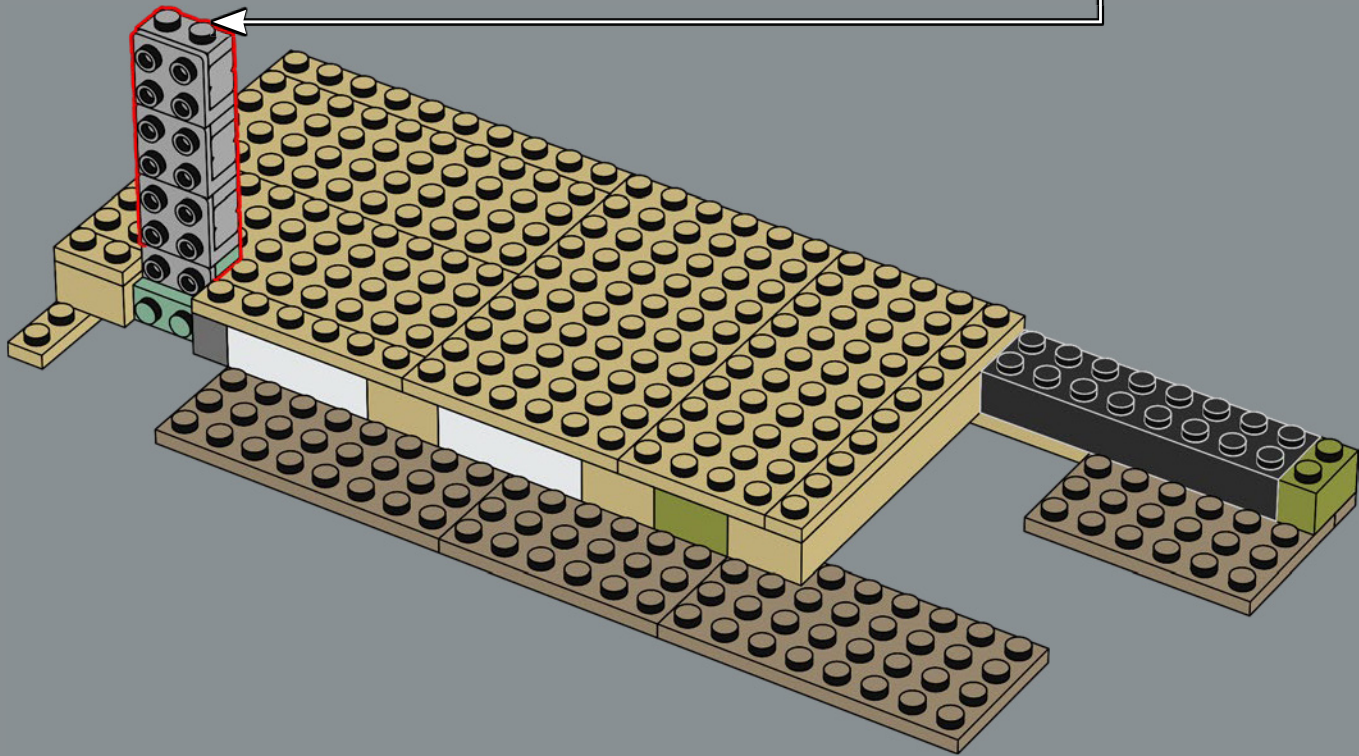
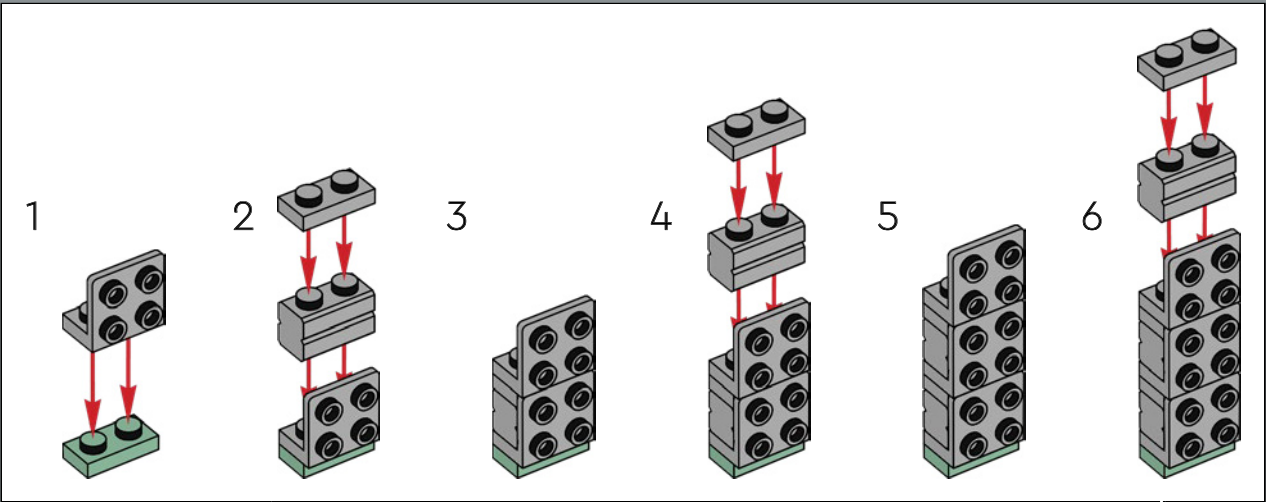

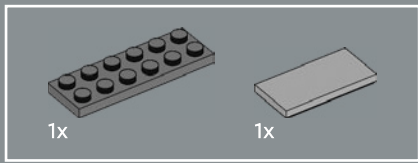

13

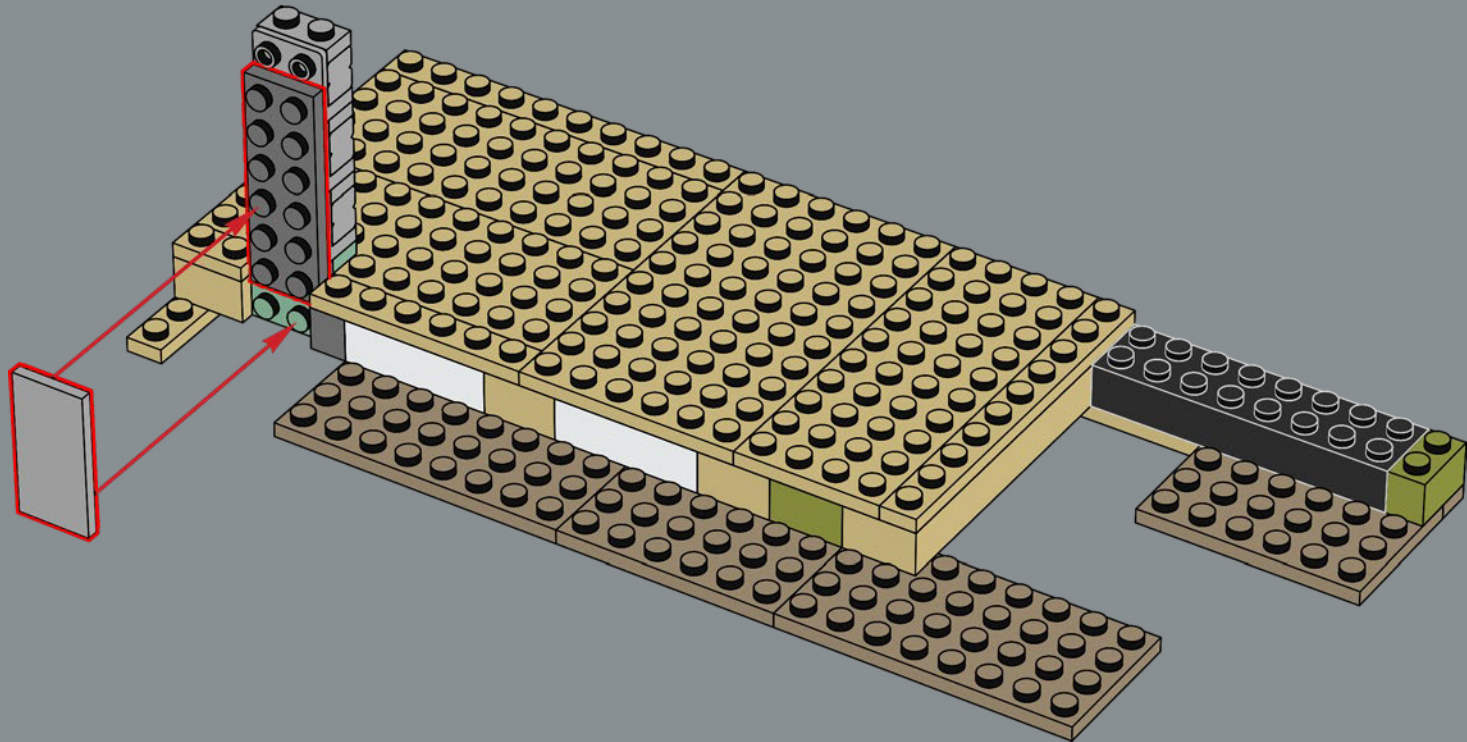

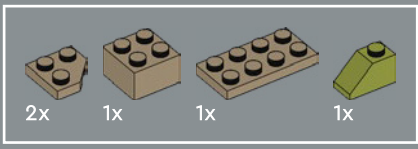

14

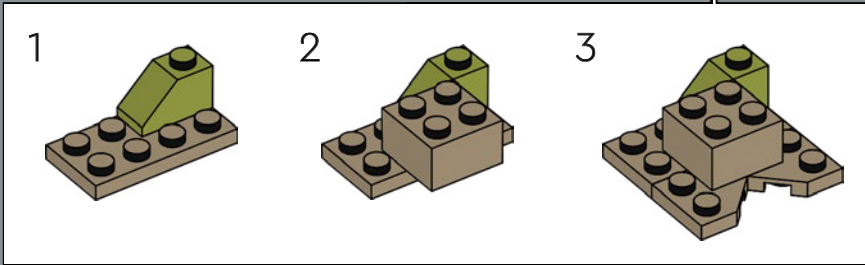
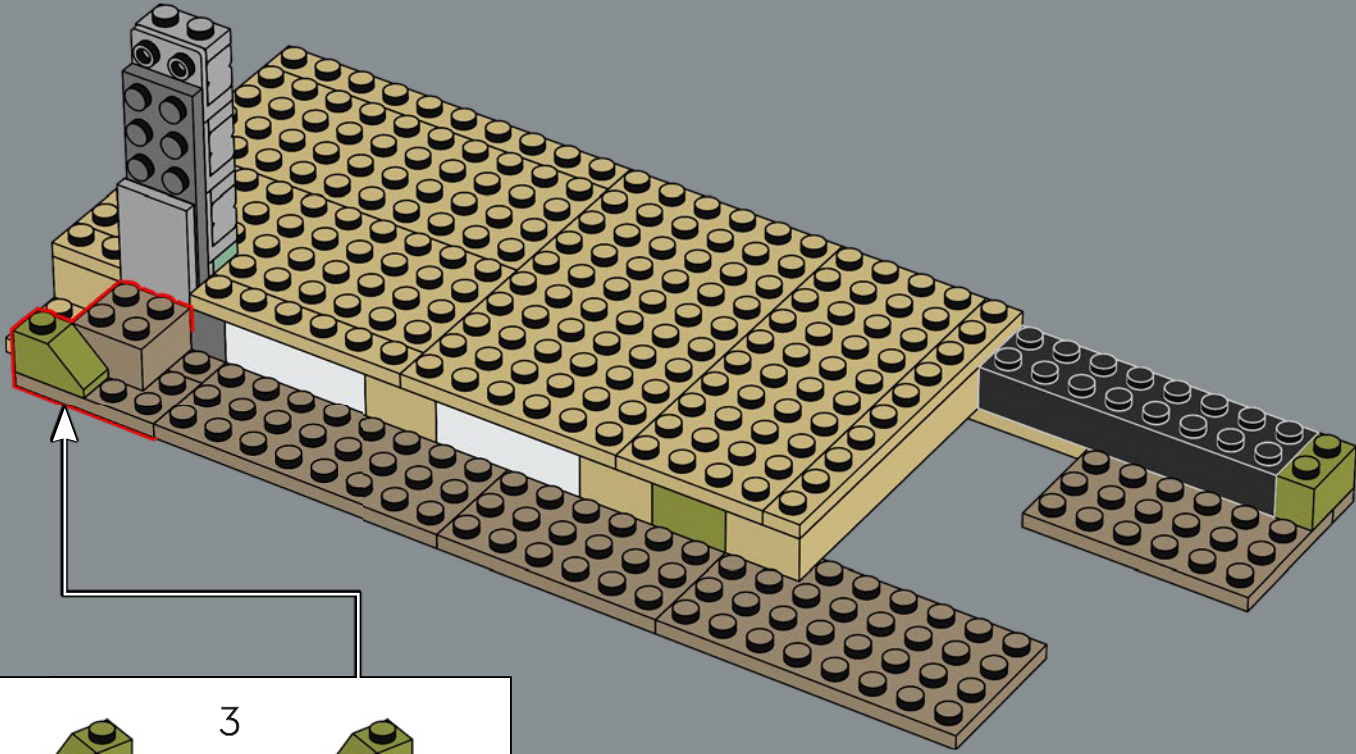

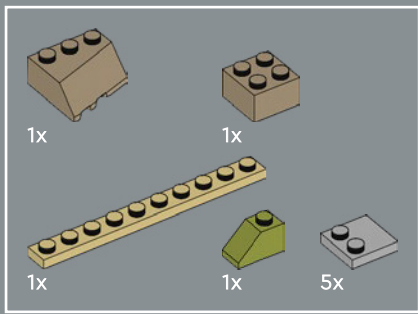

15

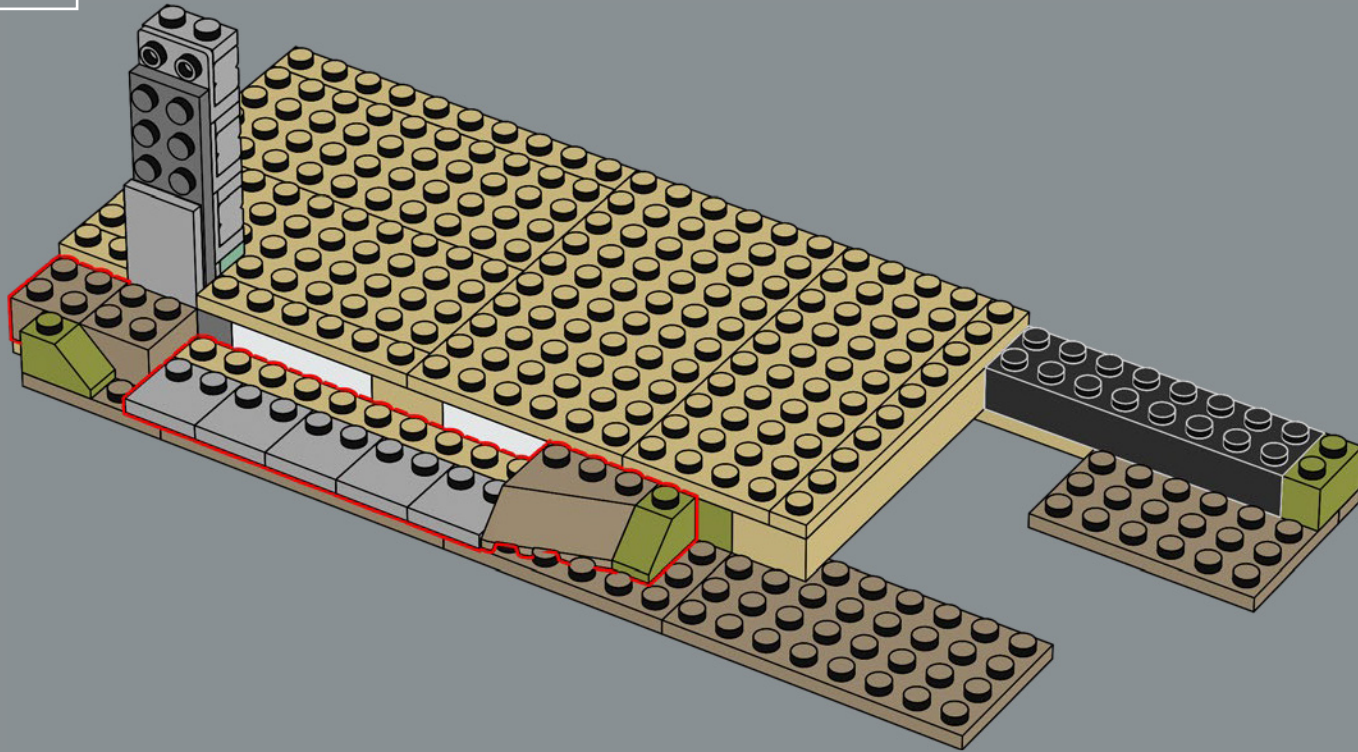

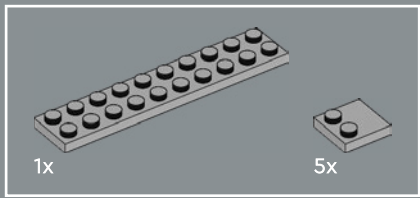

16

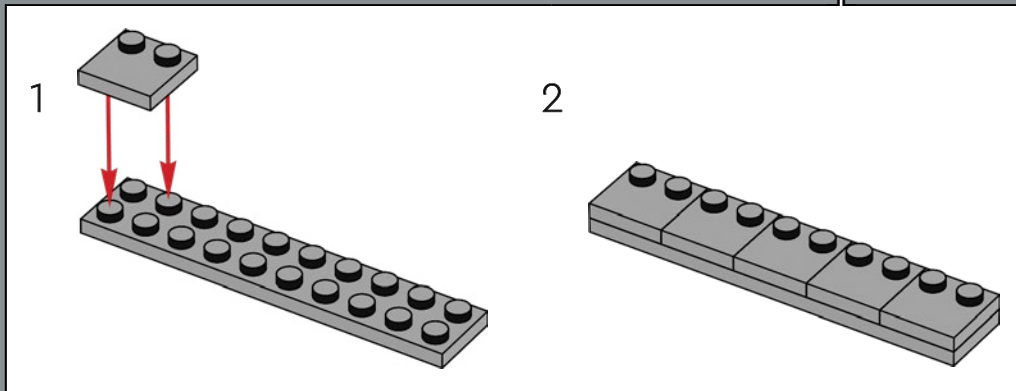
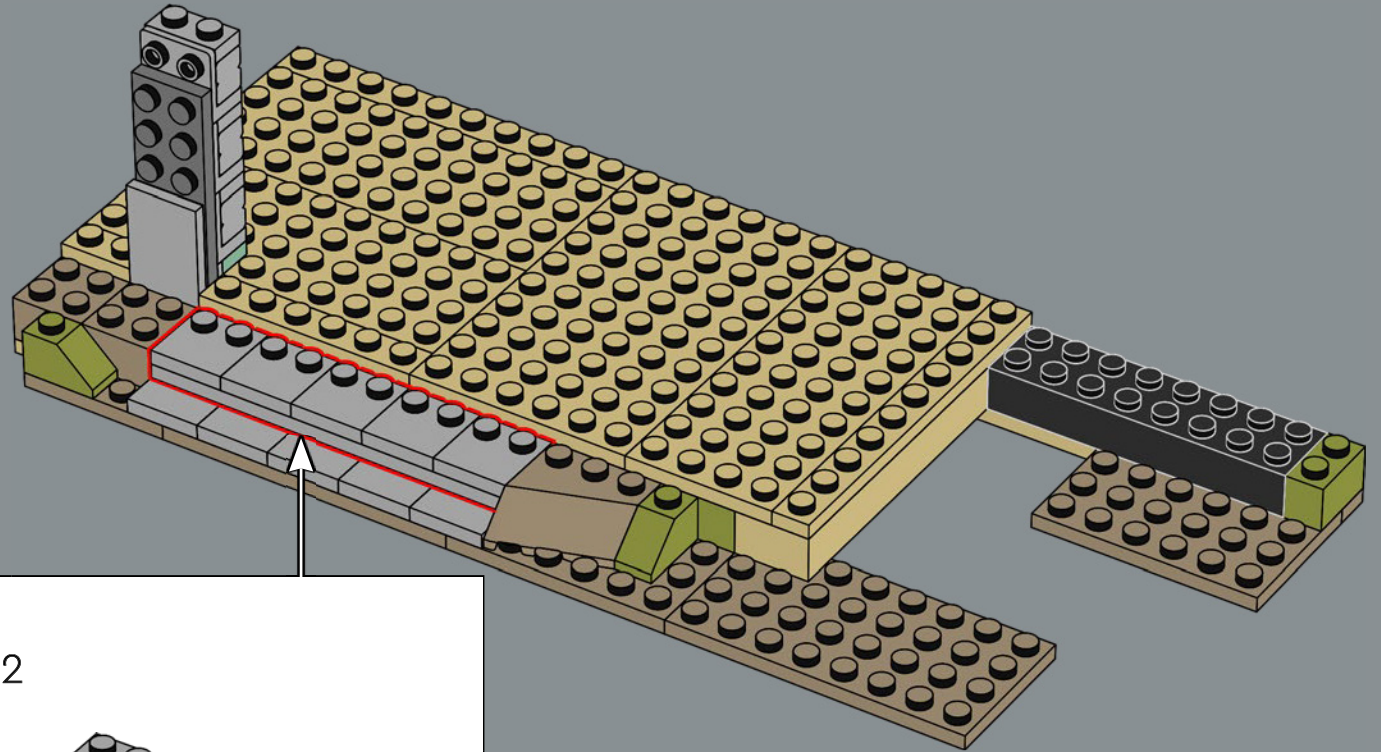

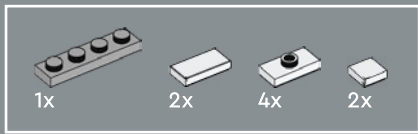

17

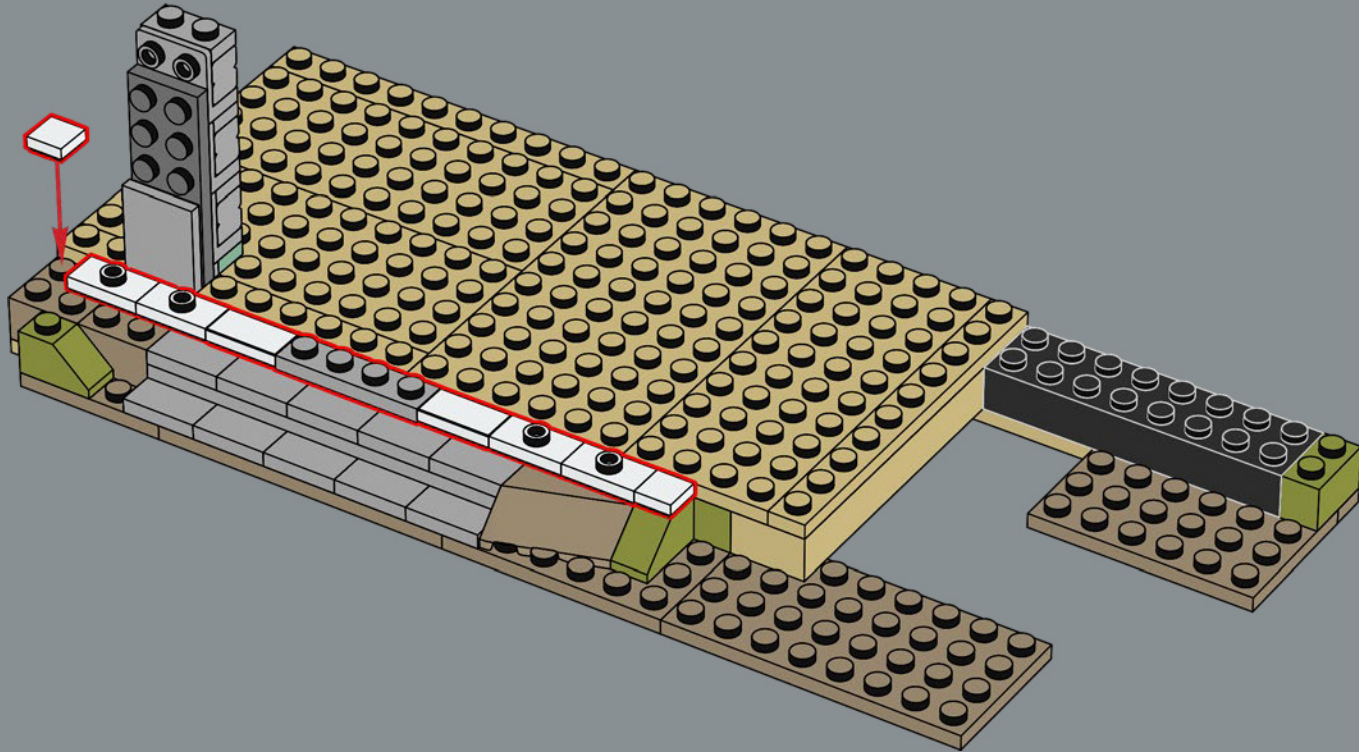

 1x	 2x
--	--

18

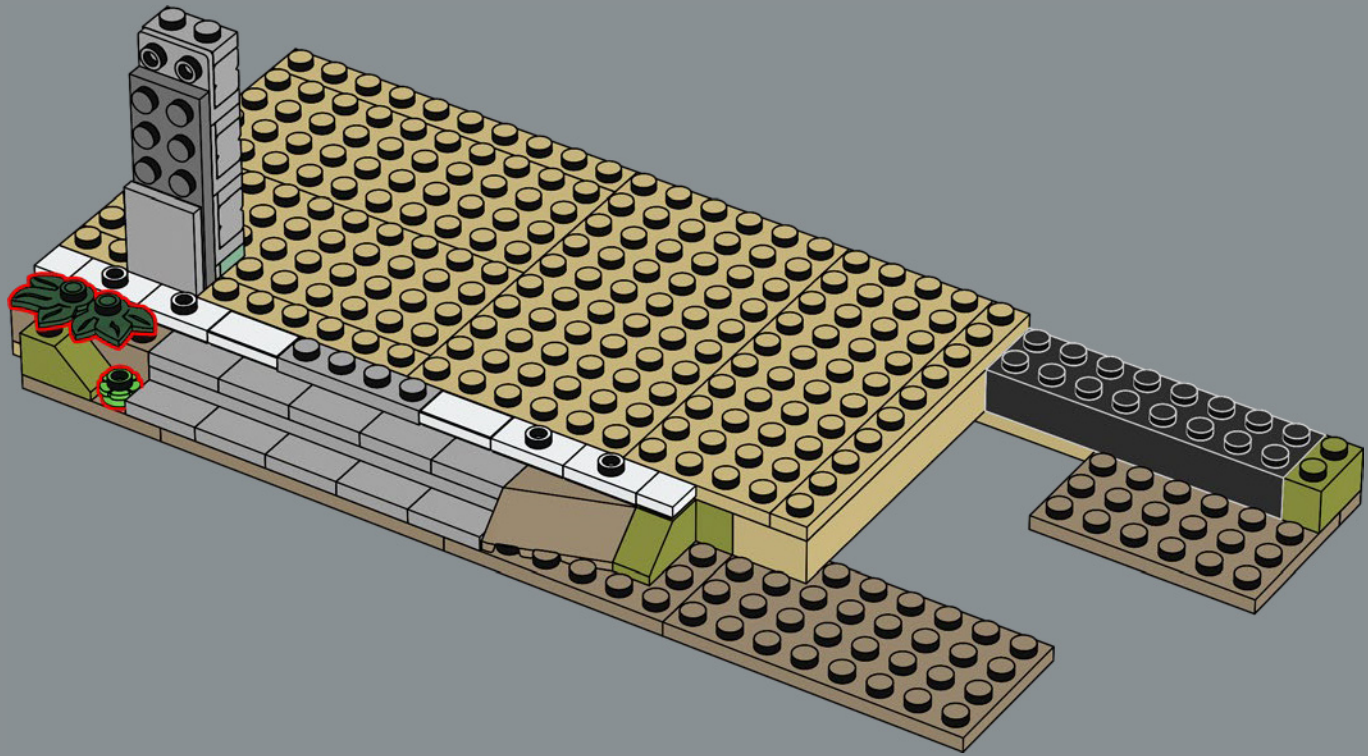

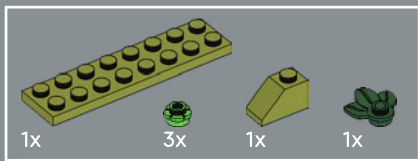

19

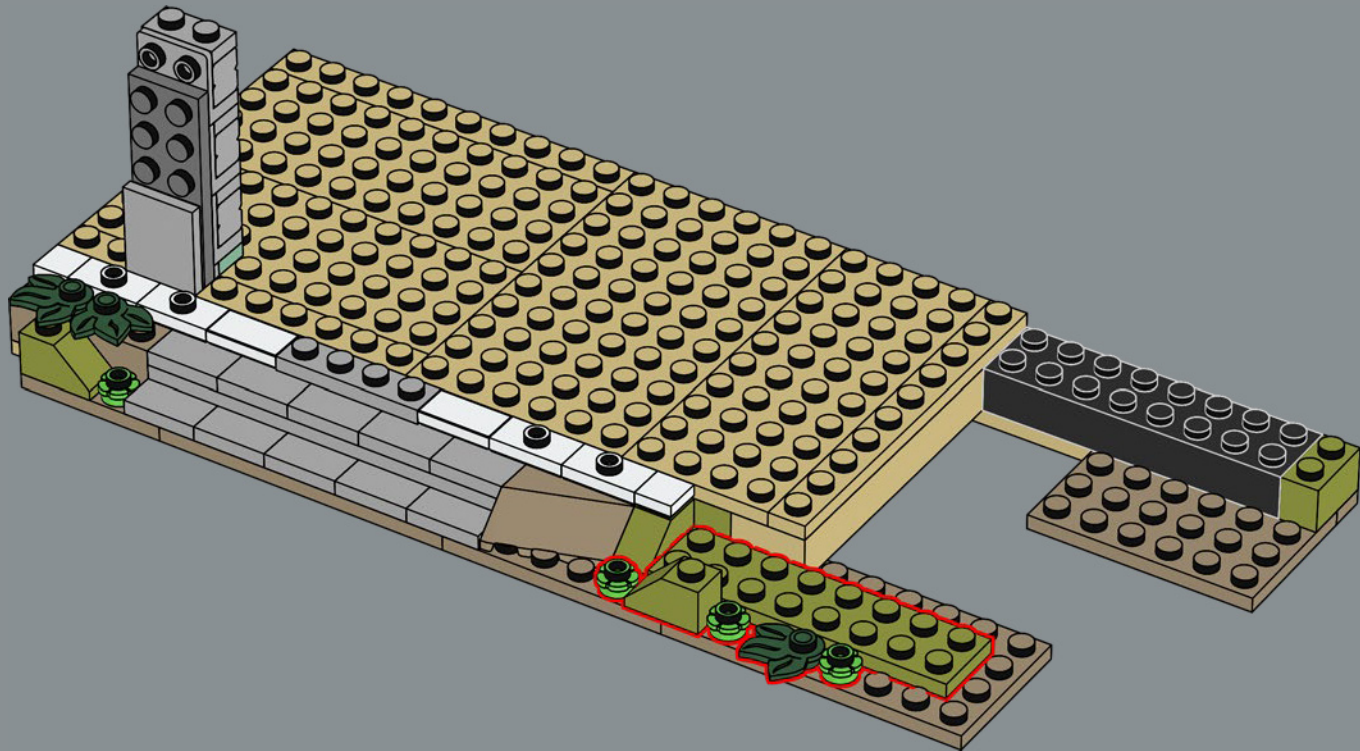

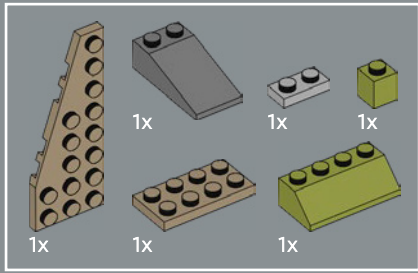

21

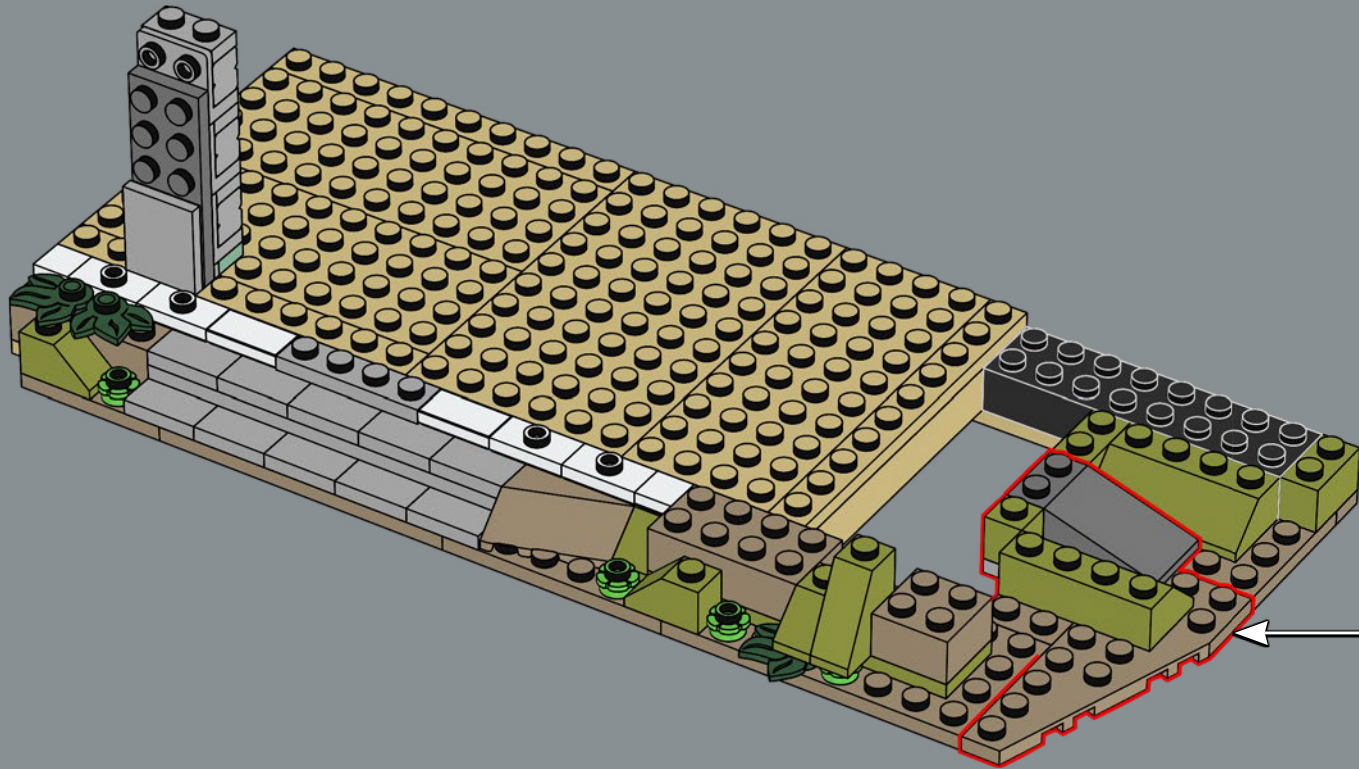
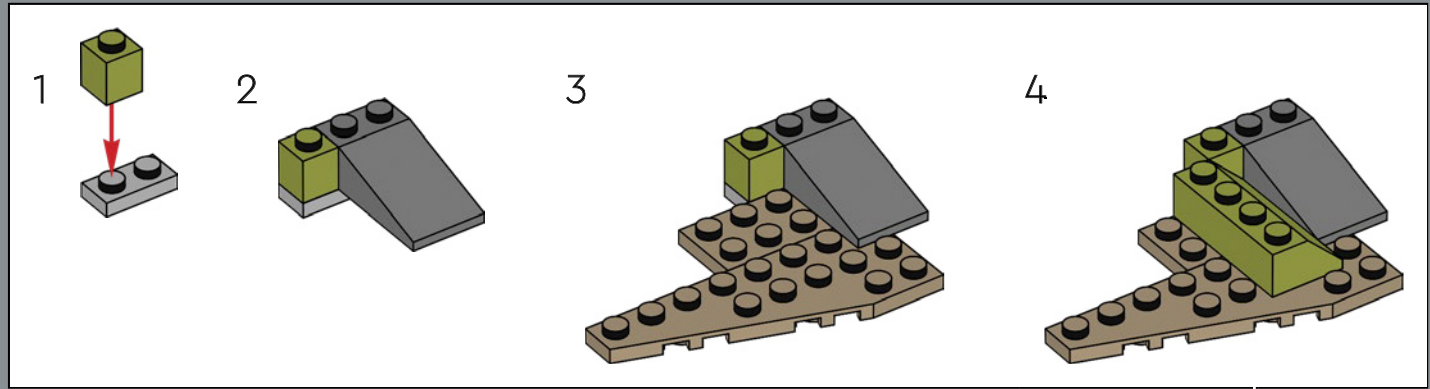

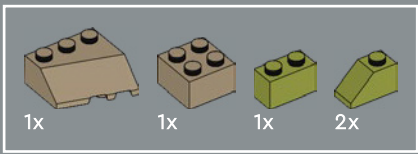

22

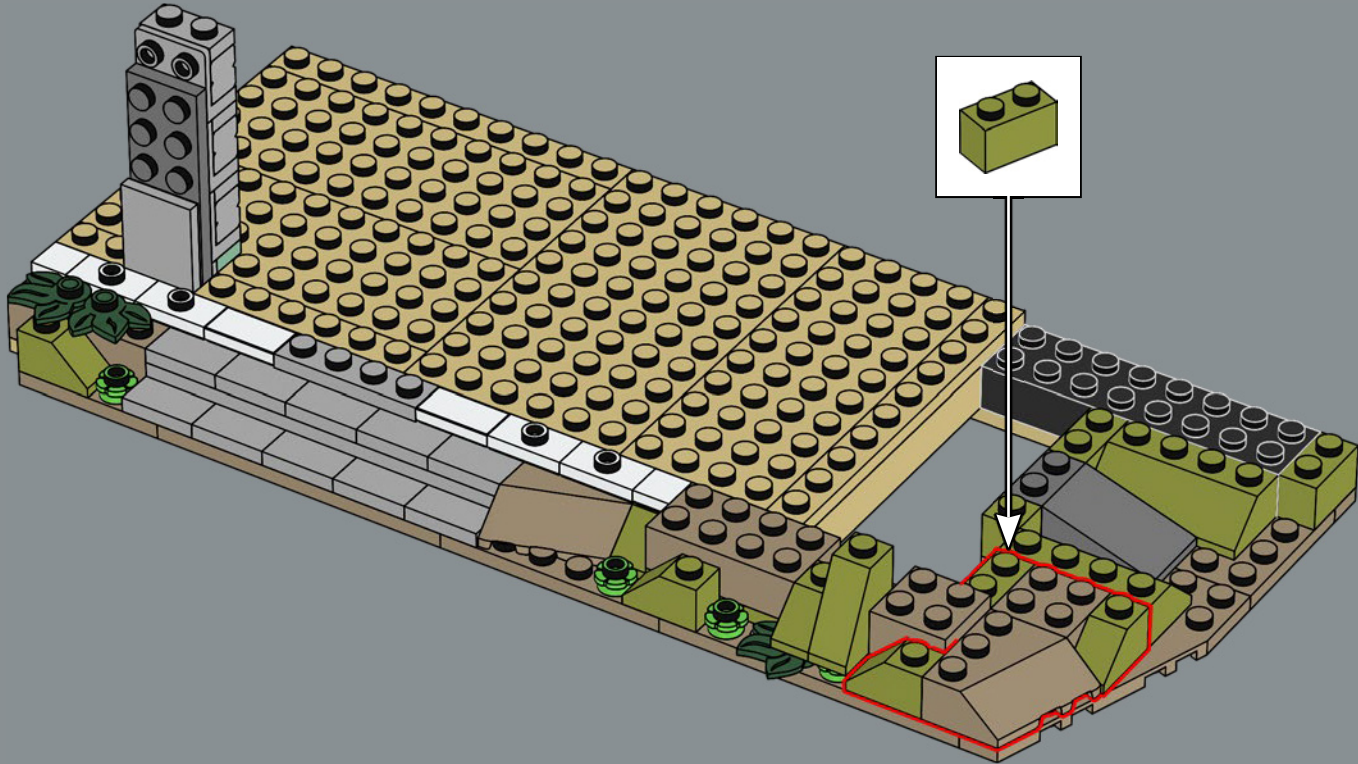

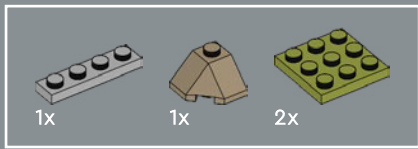

23

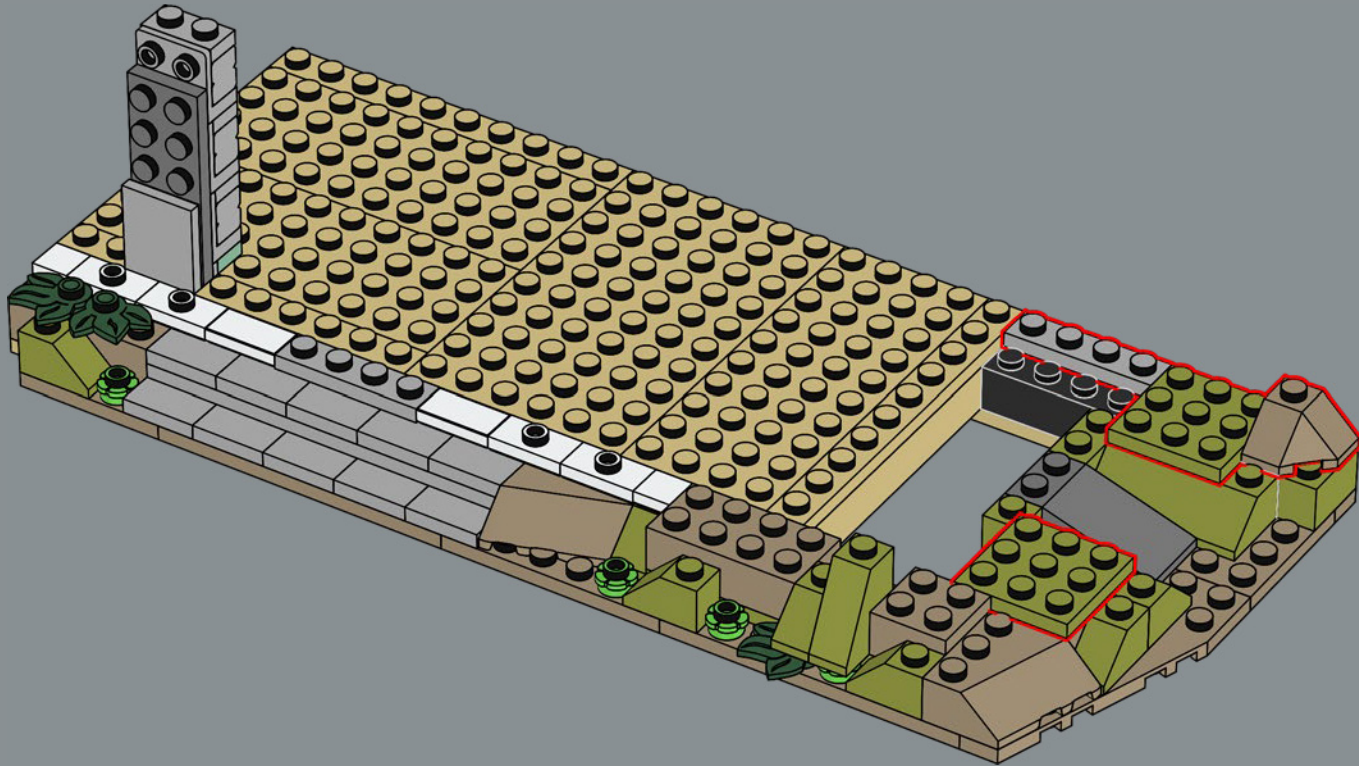

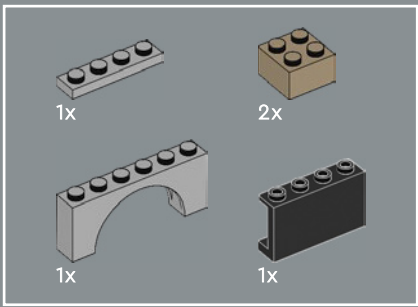

24

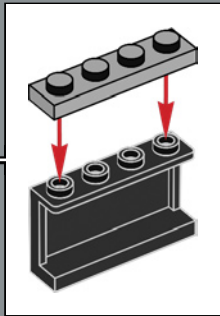
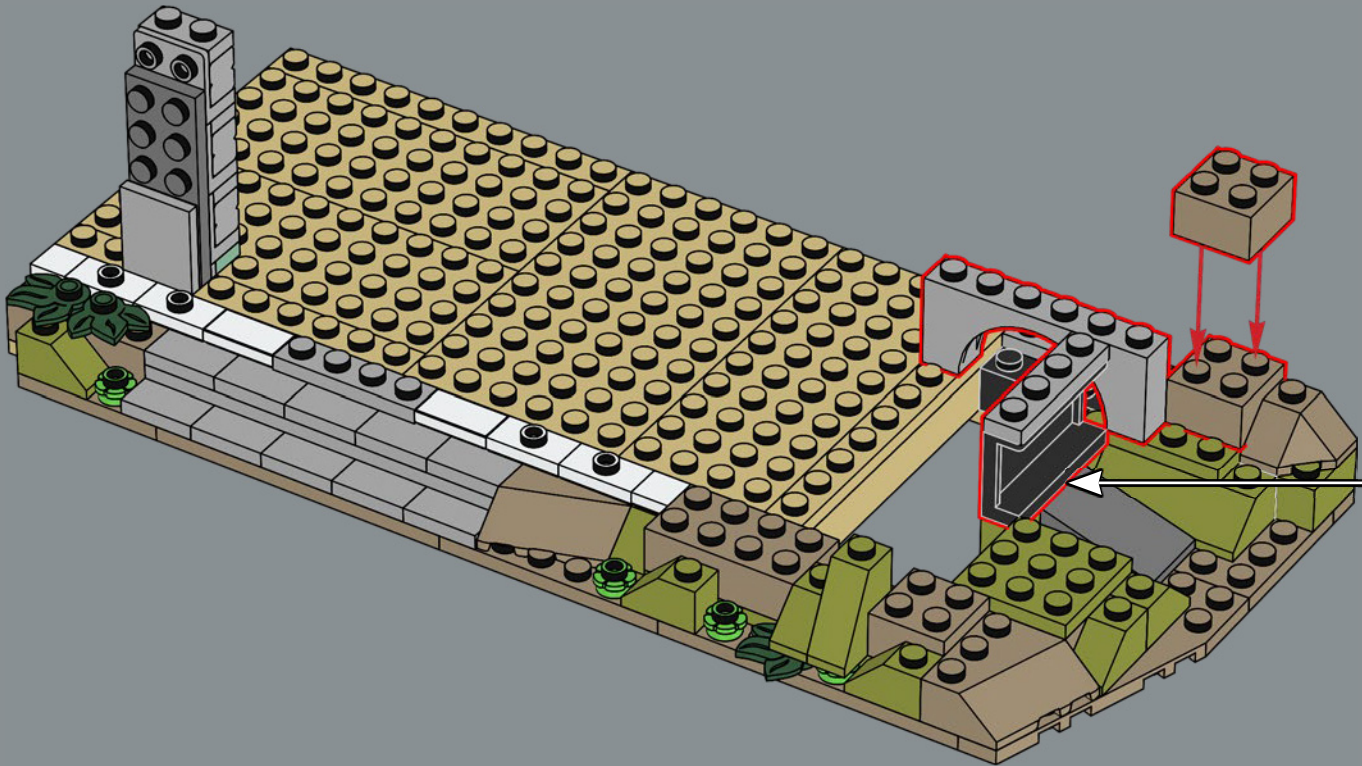

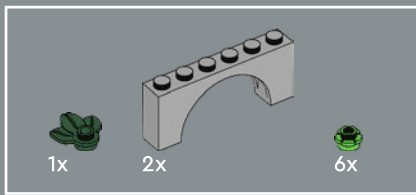

25

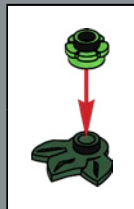
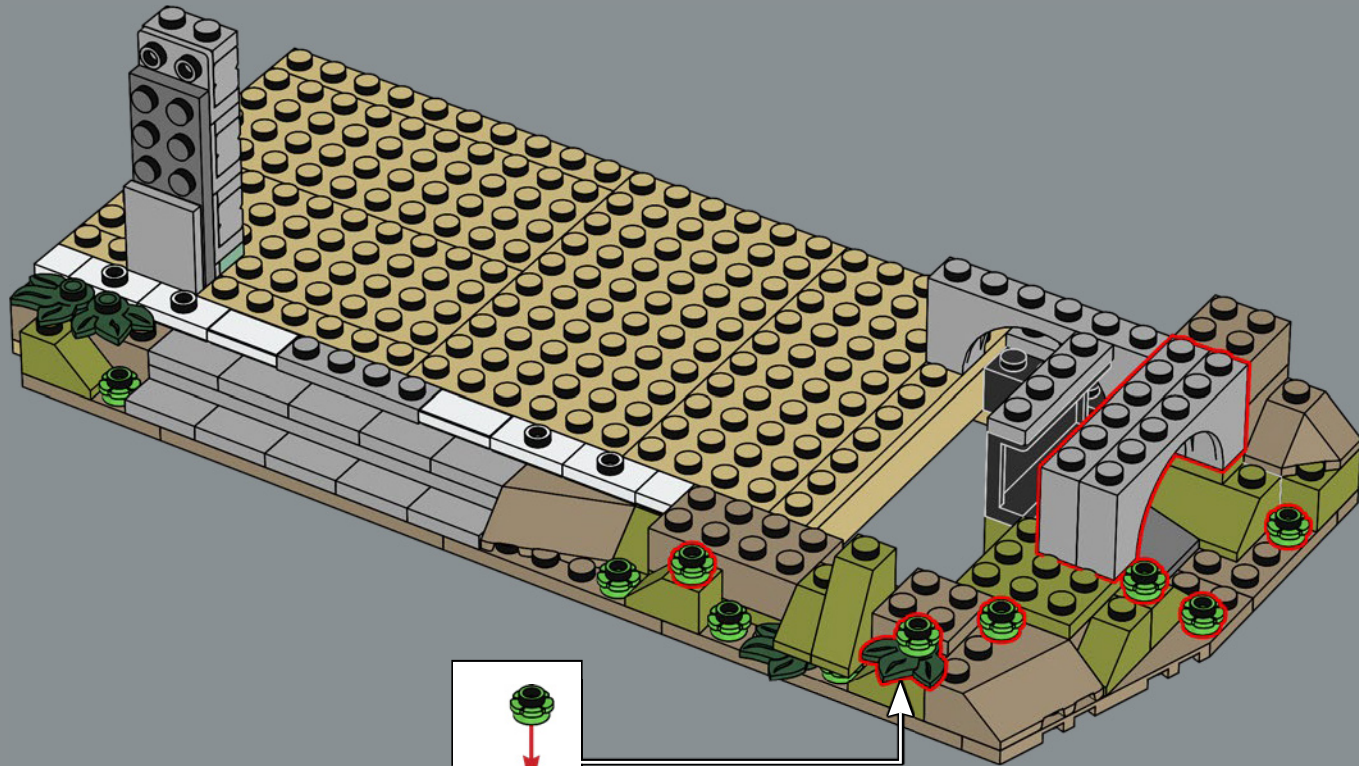

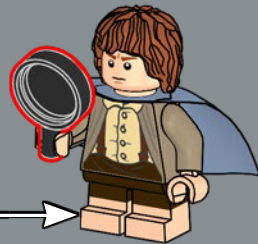
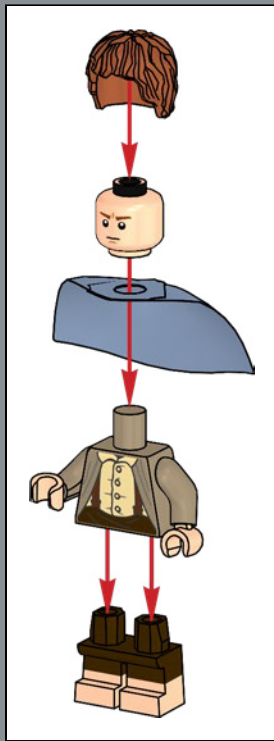
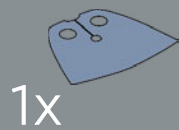
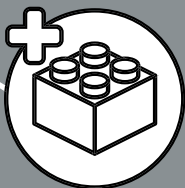

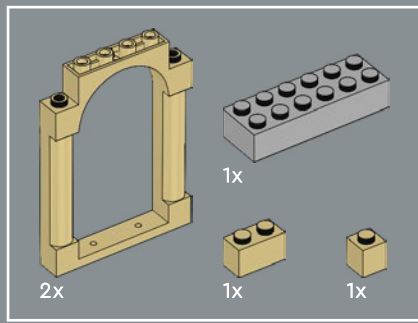

26

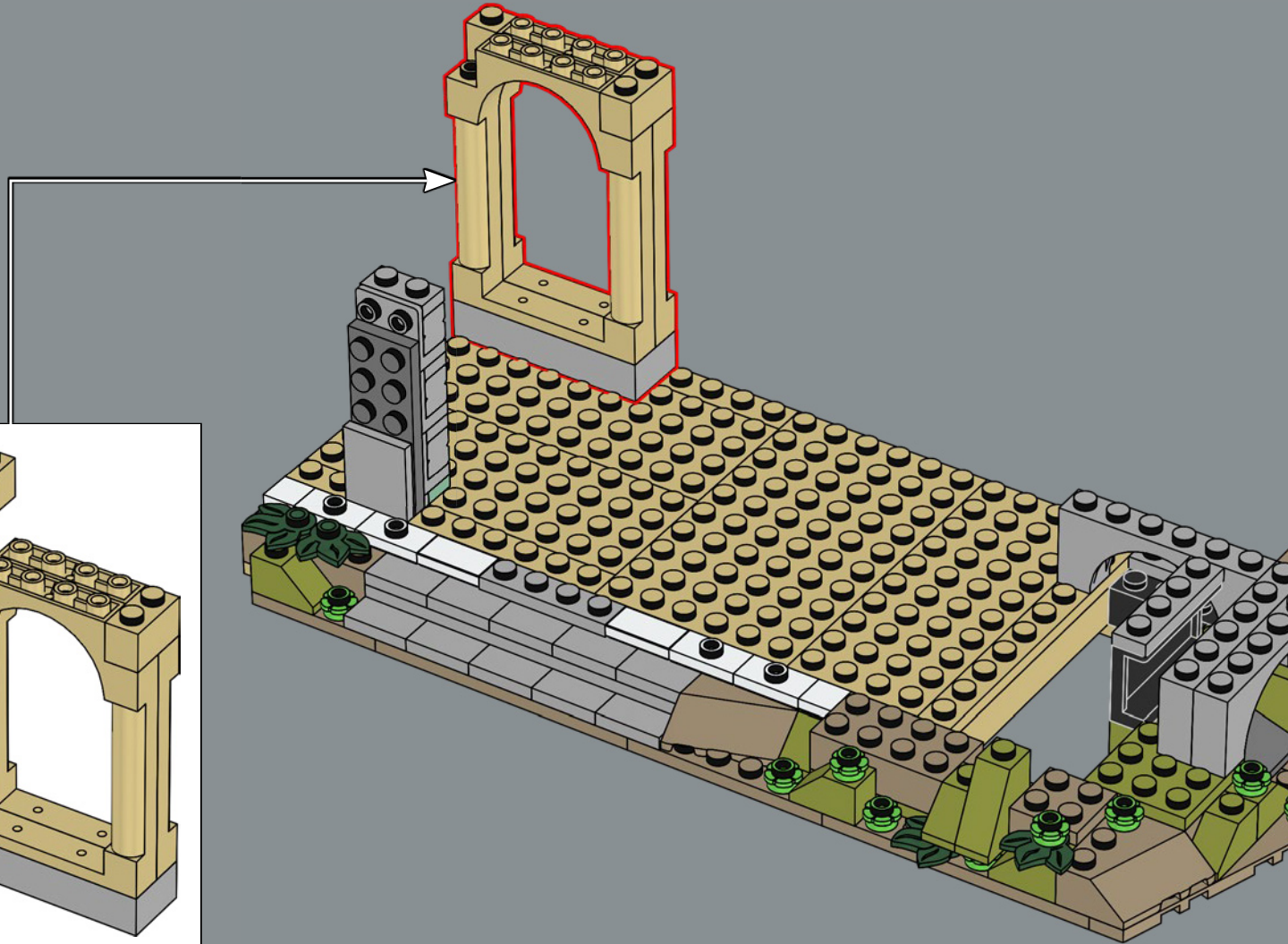
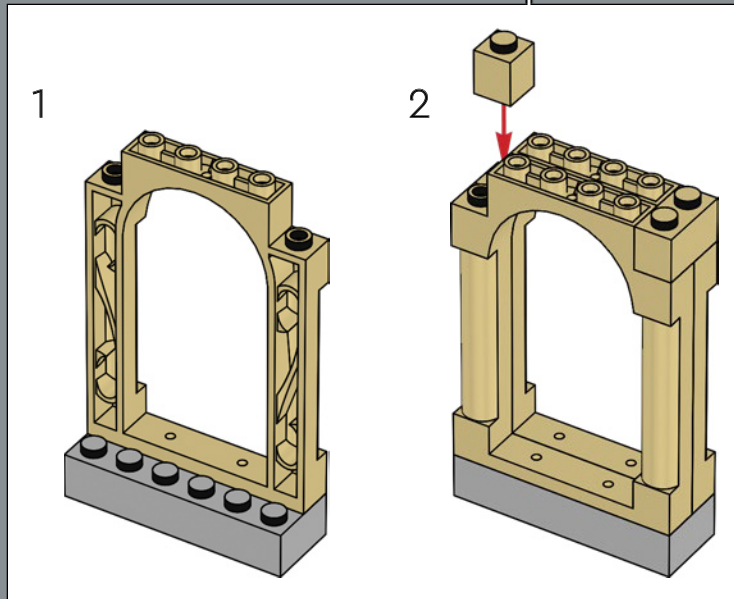

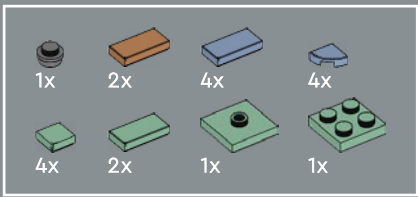

27

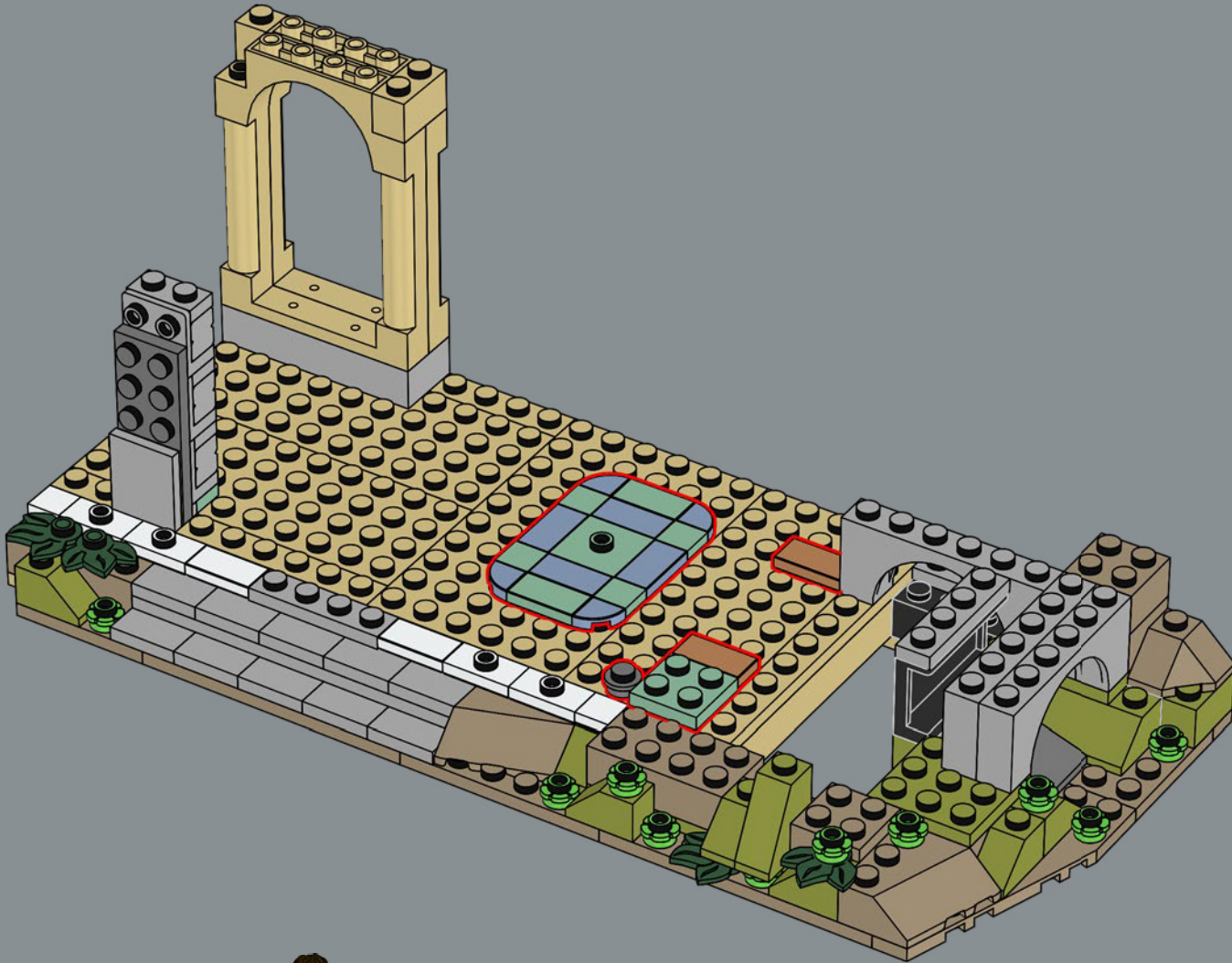

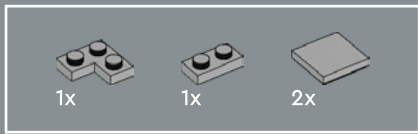

28

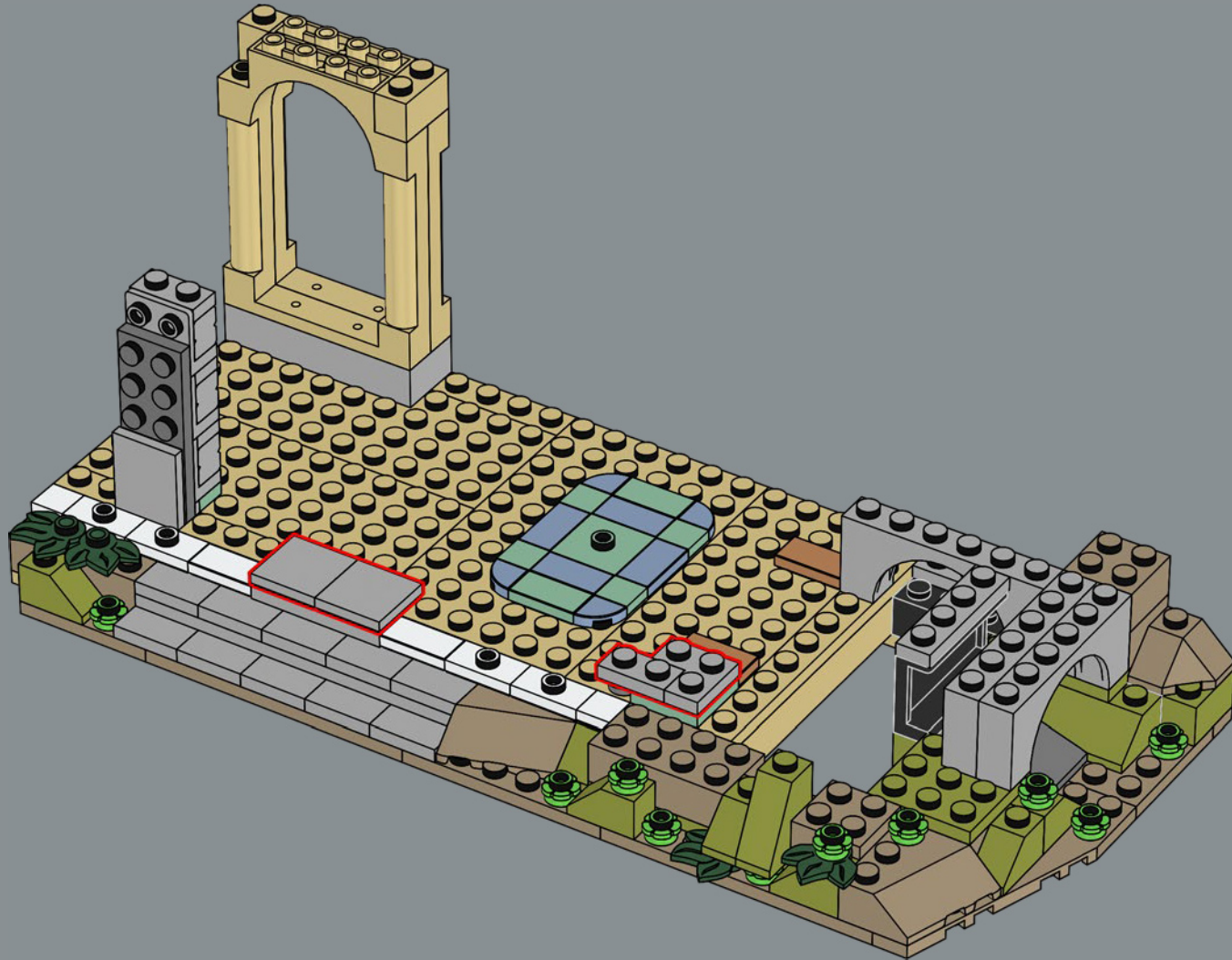



2x

29

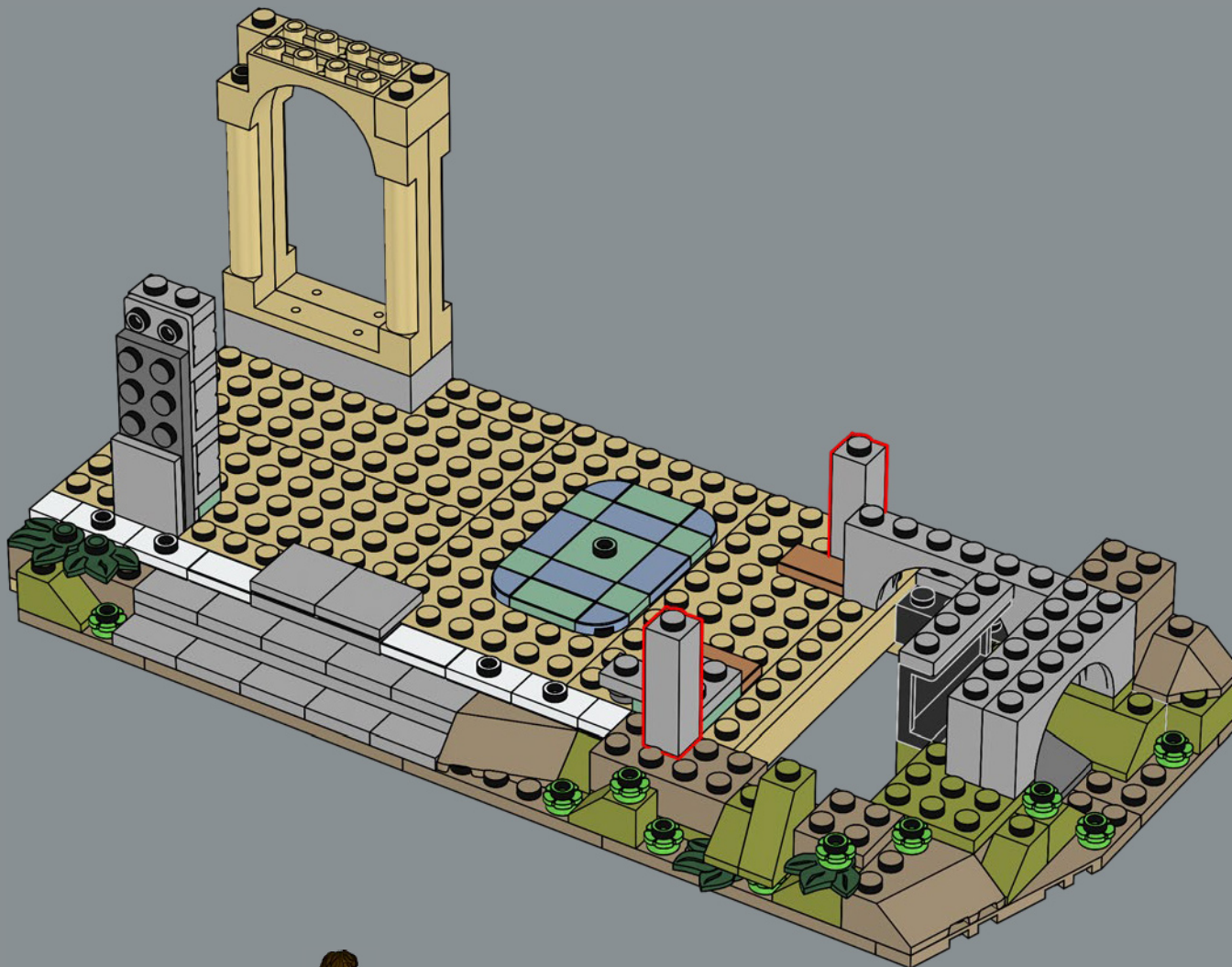



La fougère, introduite pour la première fois en 2023, apparaît 34 fois dans ce modèle !

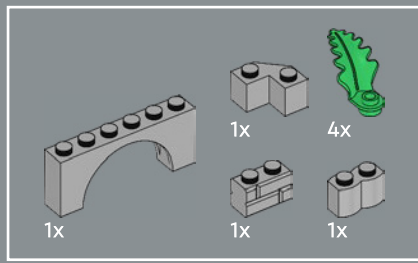

30

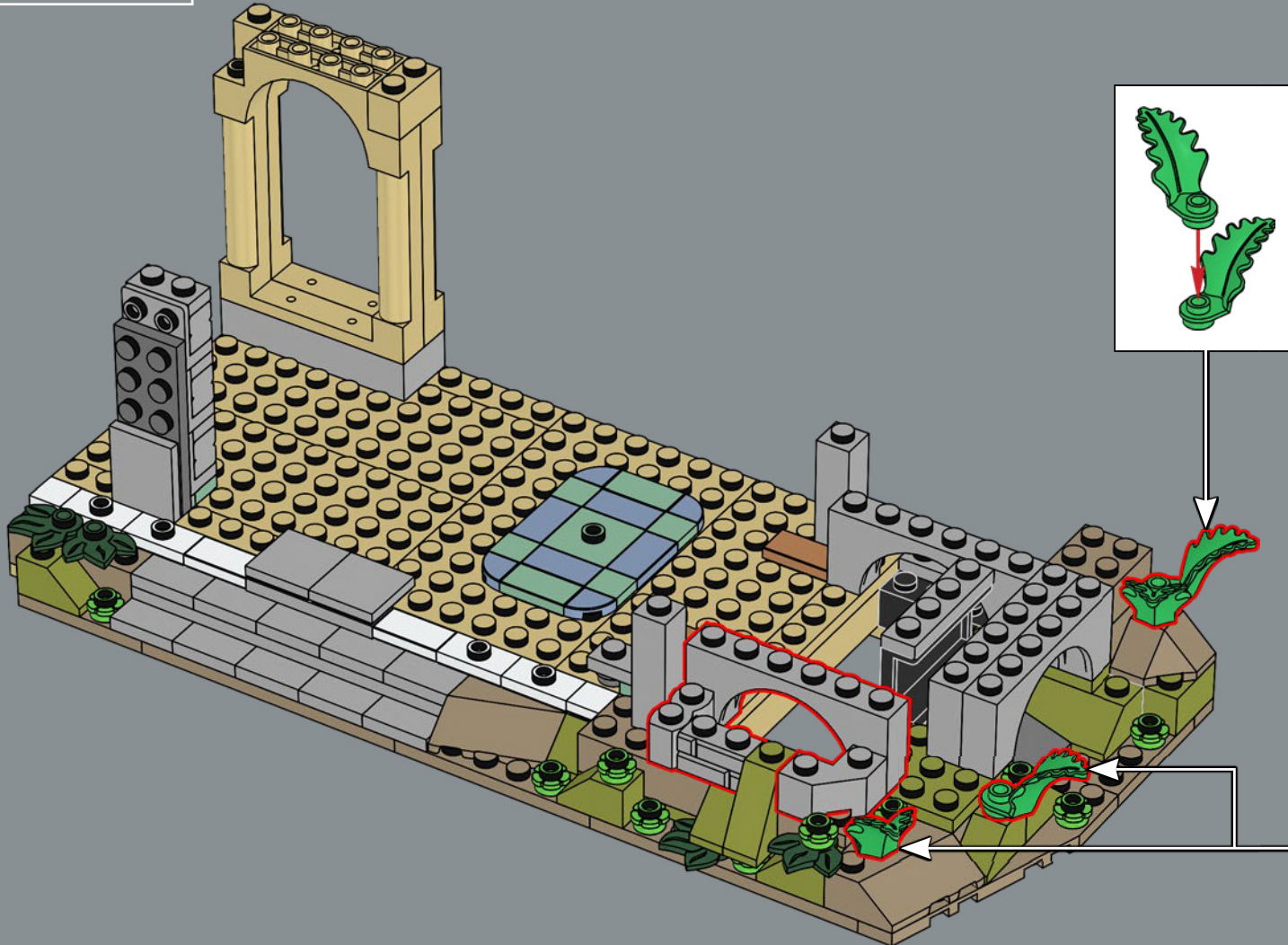

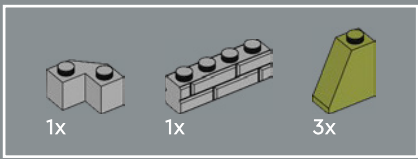

31

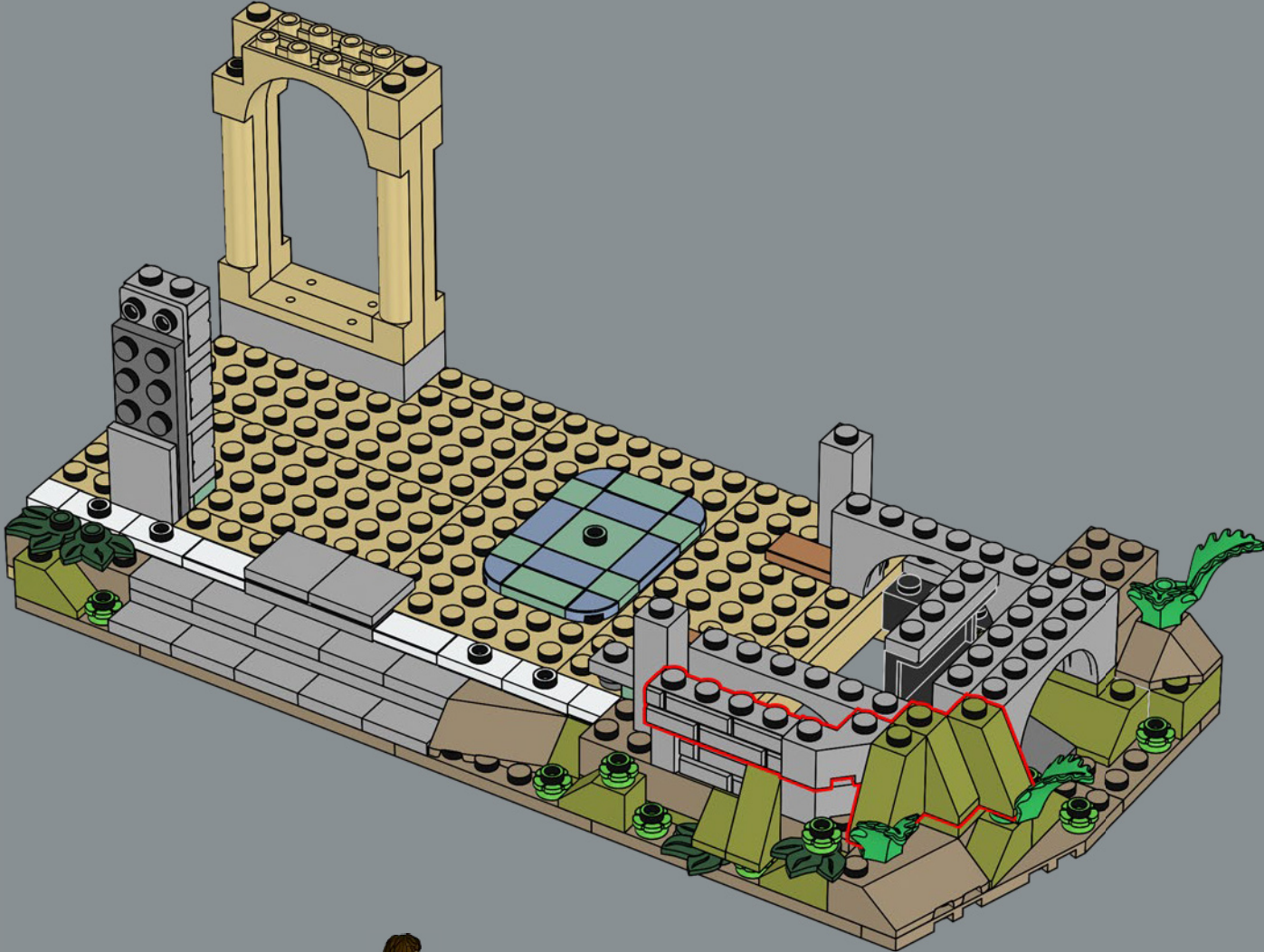

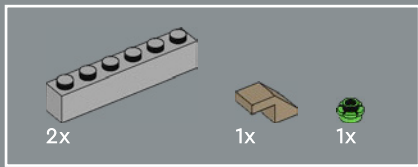

32

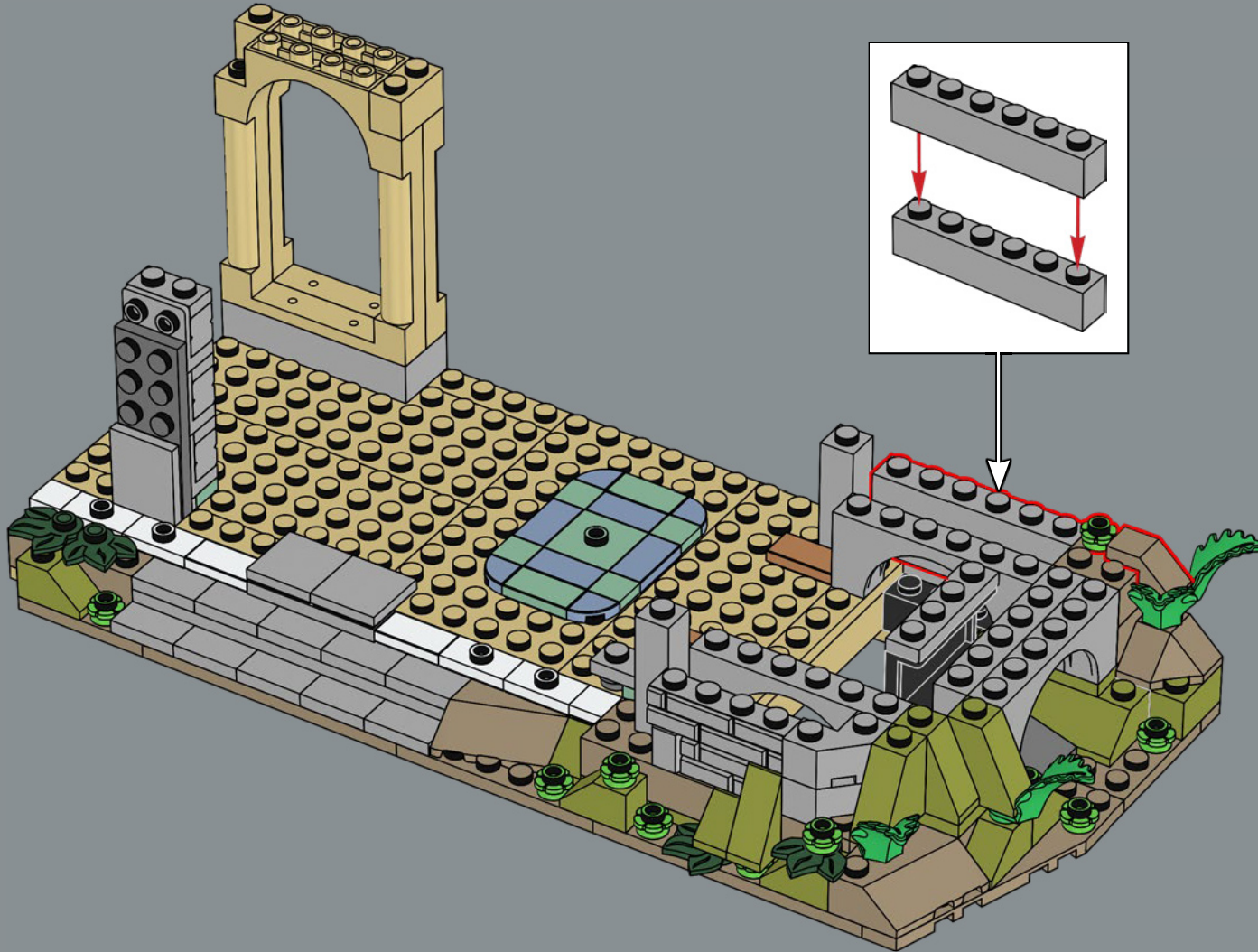

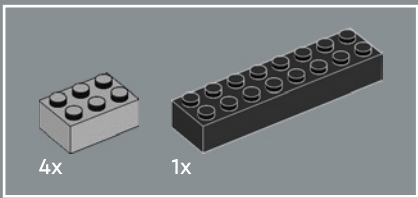

33

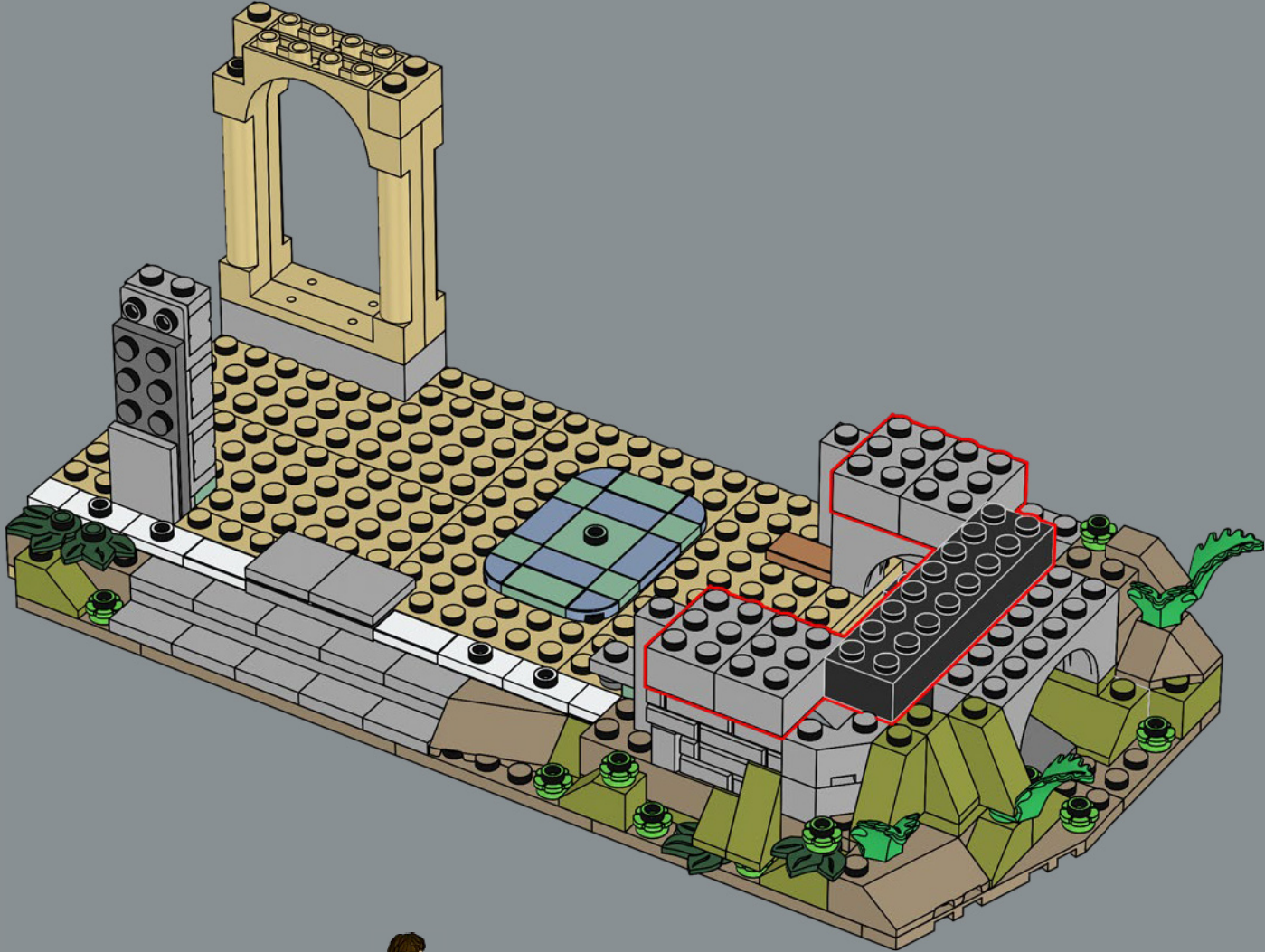

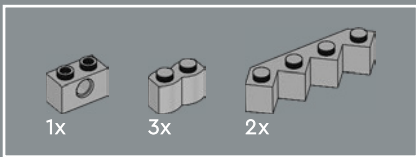

34

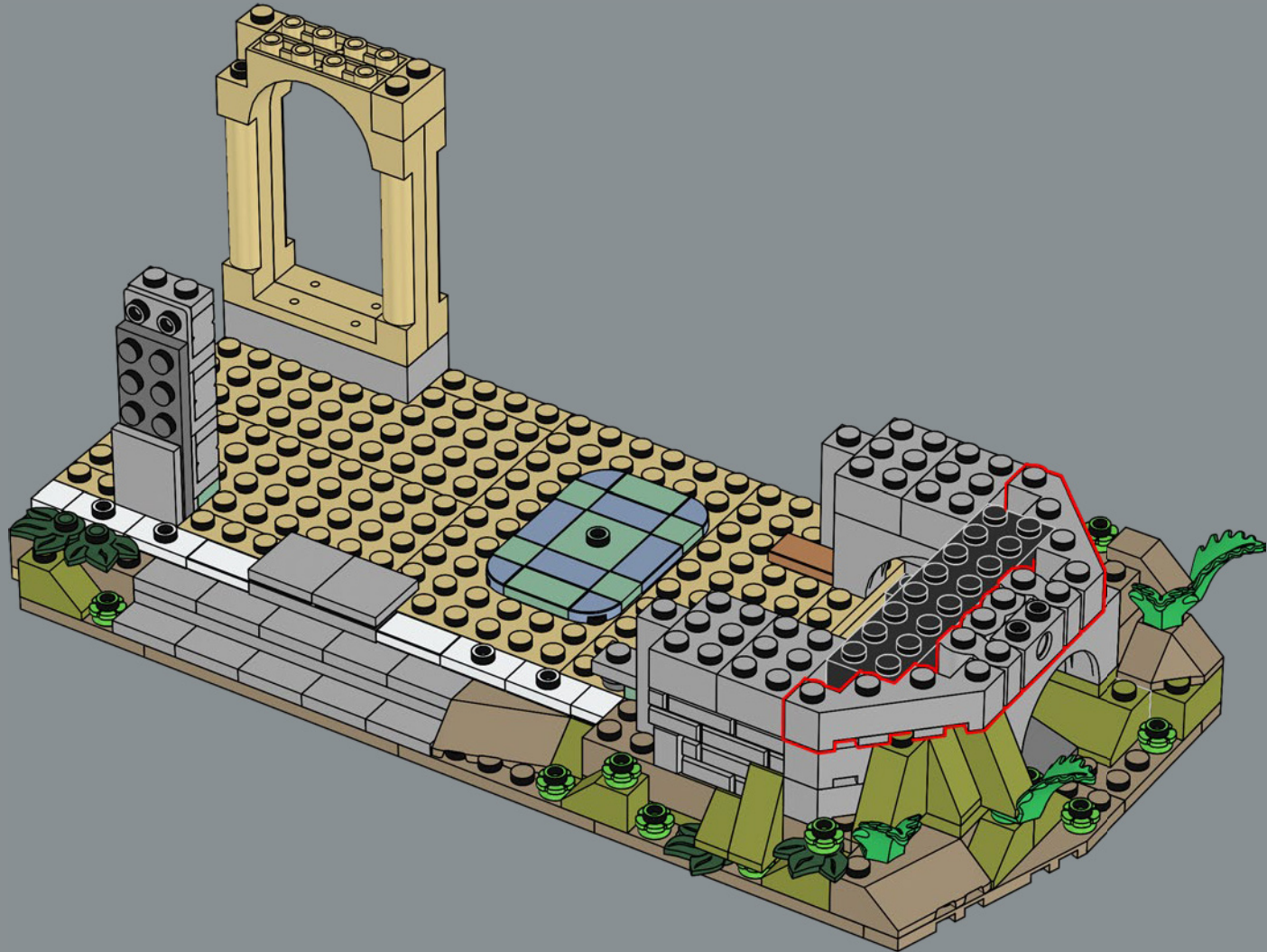

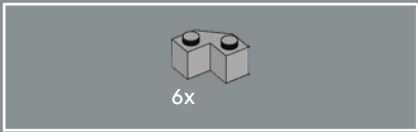

35

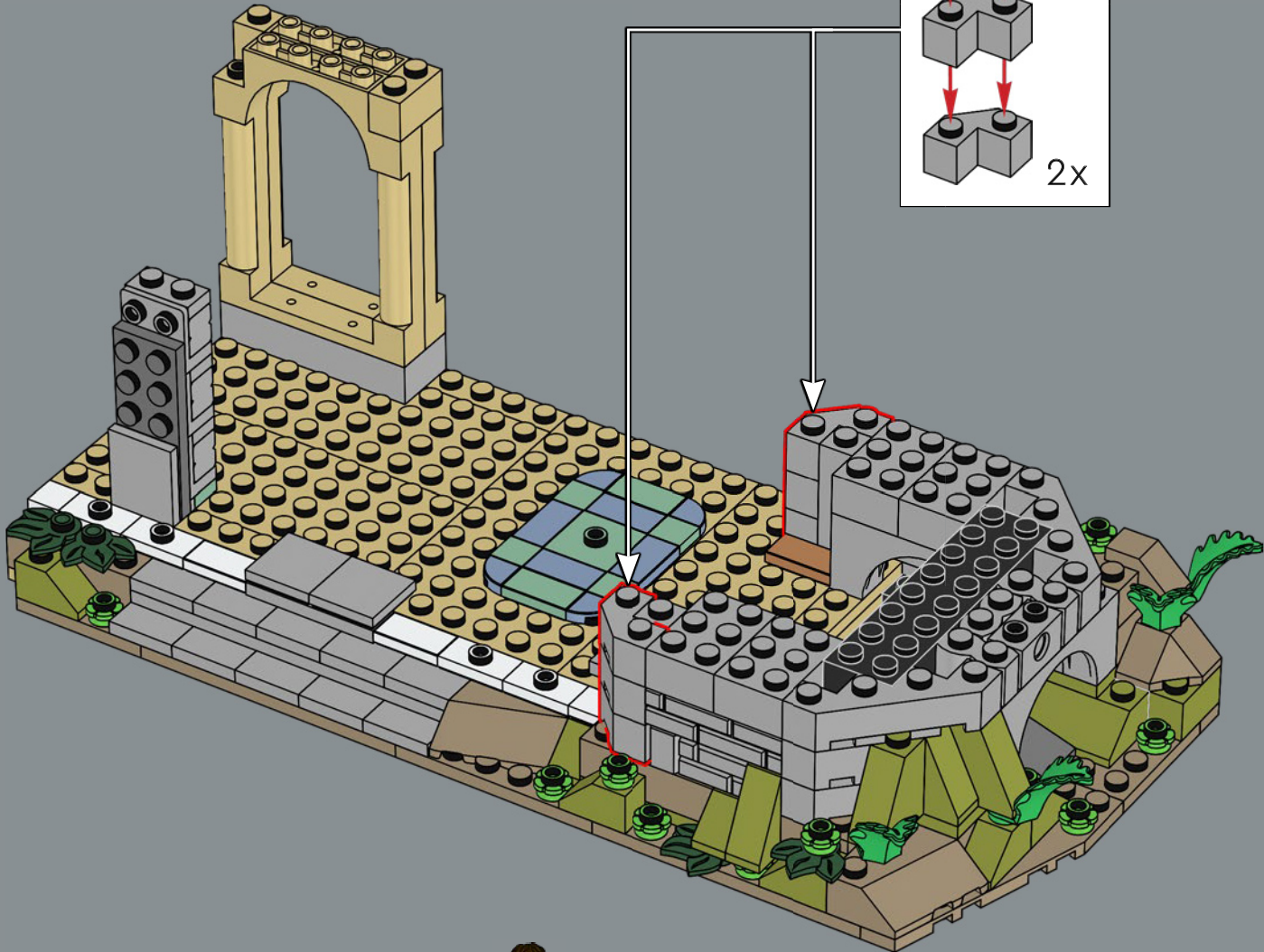
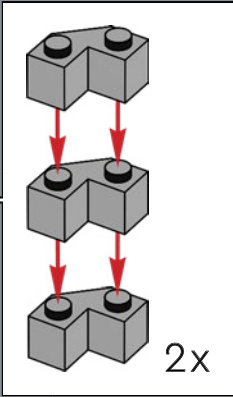

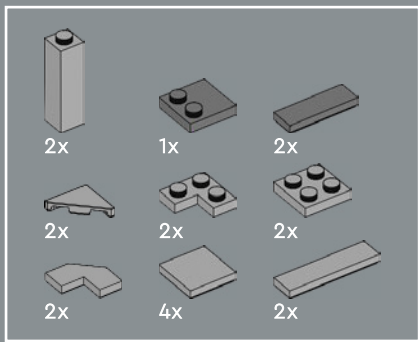

36

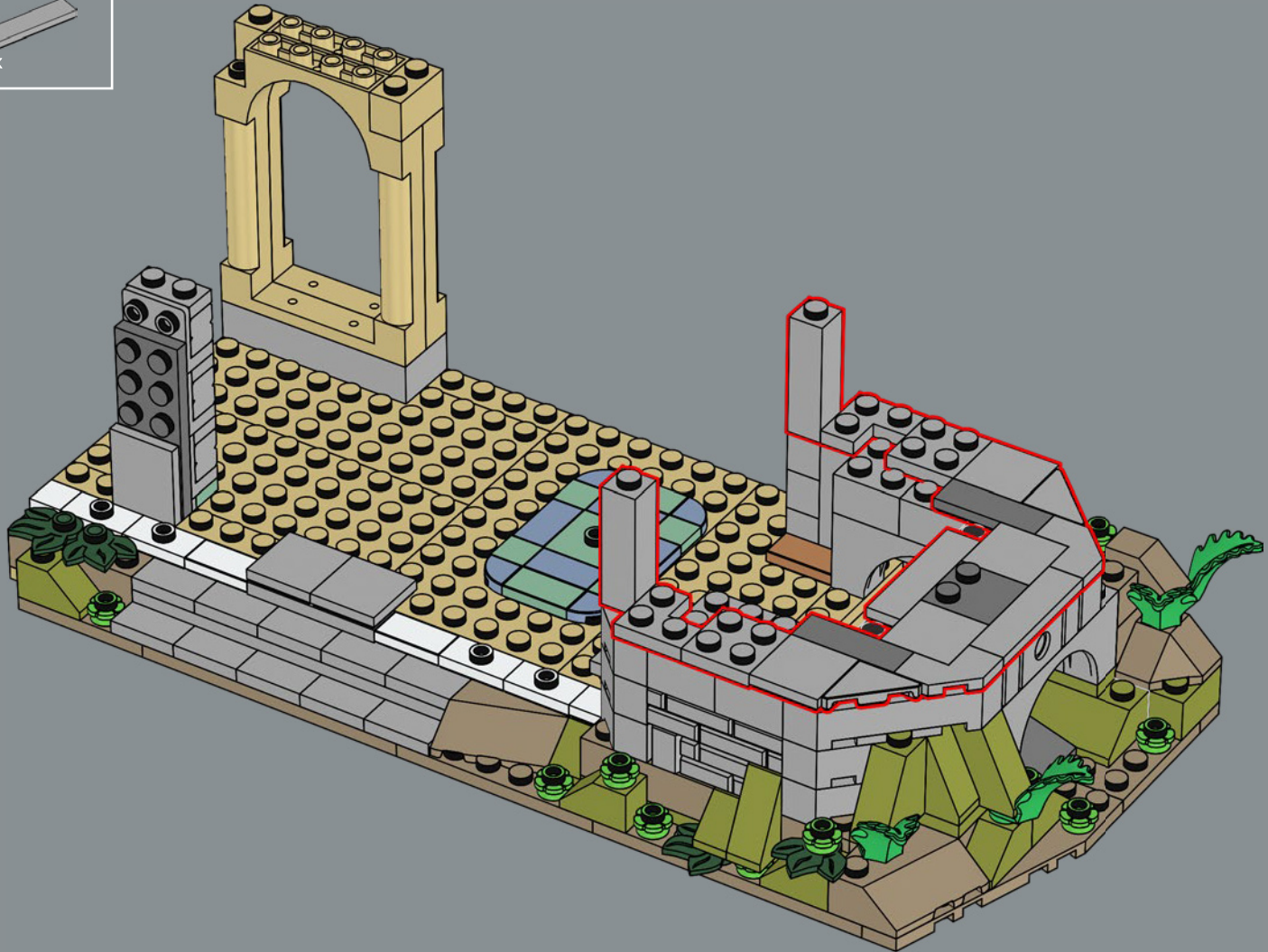

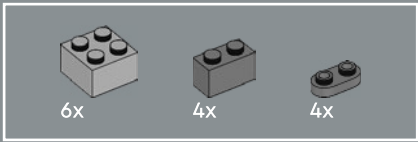

37

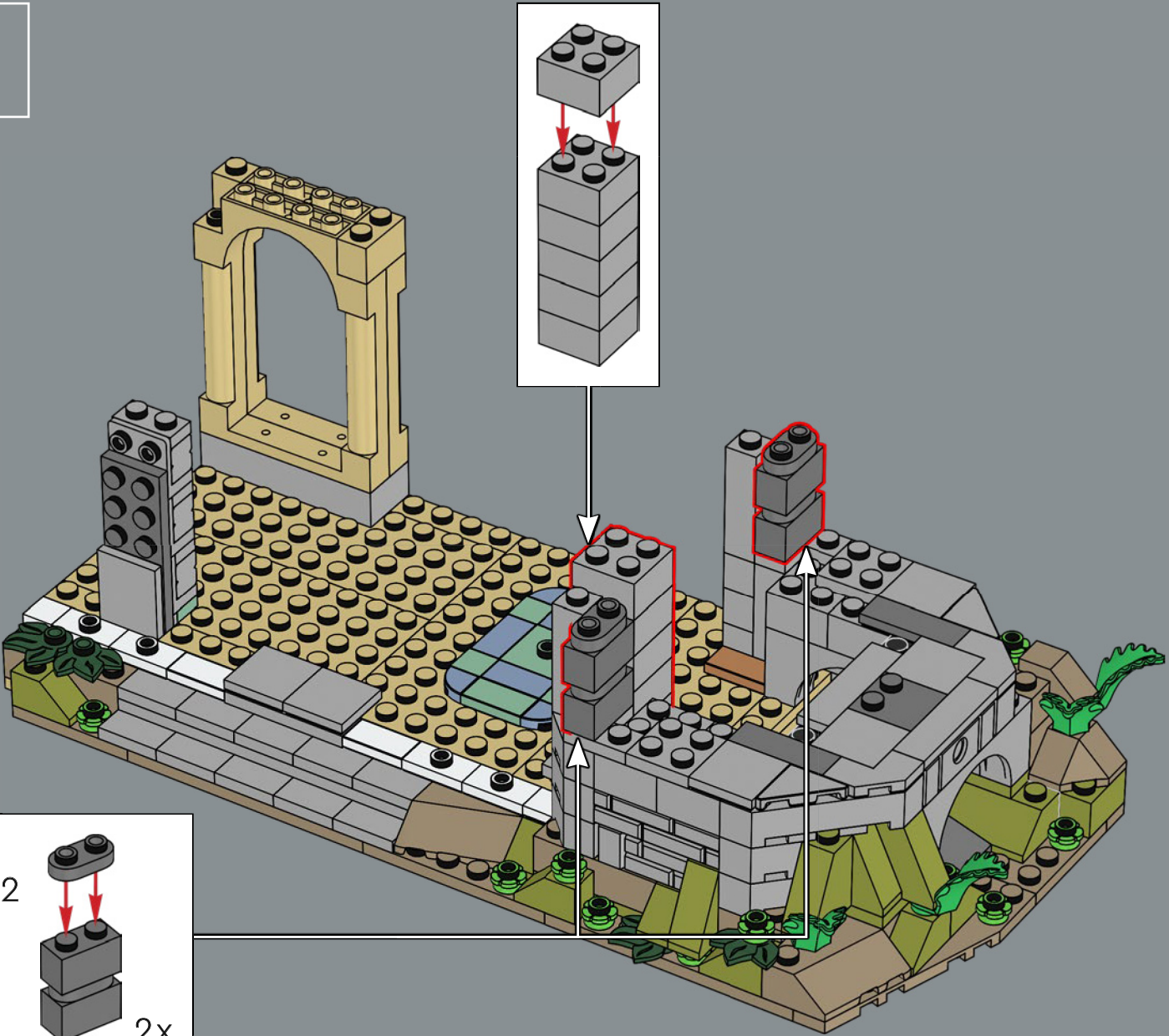

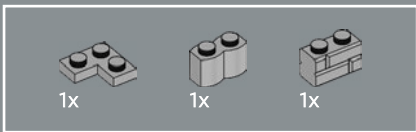

38

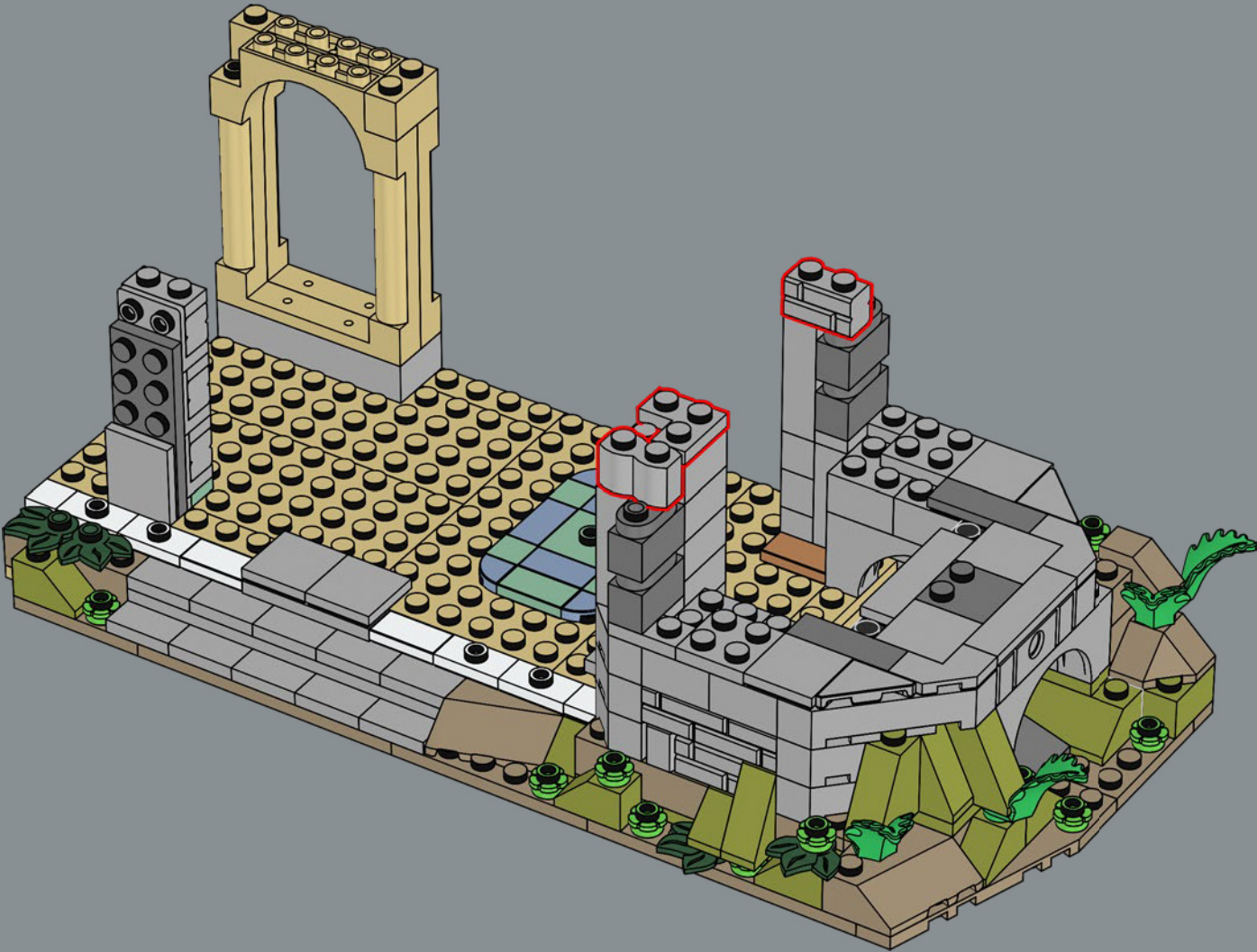



Cette cachette de Samsagace Gamegie est l'un des derniers éléments ajoutés à ce modèle.

- 3x
- 1x
- 1x
- 3x
- 1x

39

1



2



3



4



5



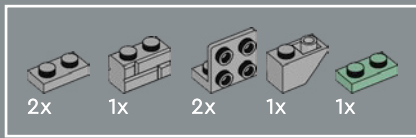

40

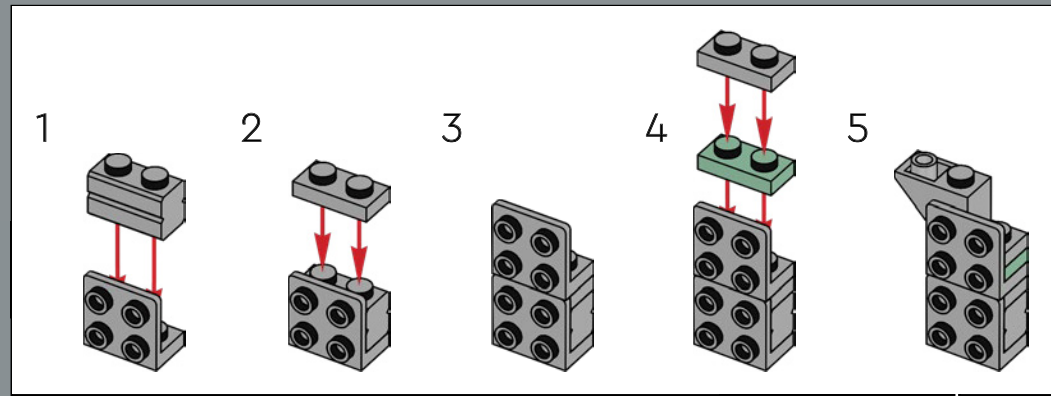
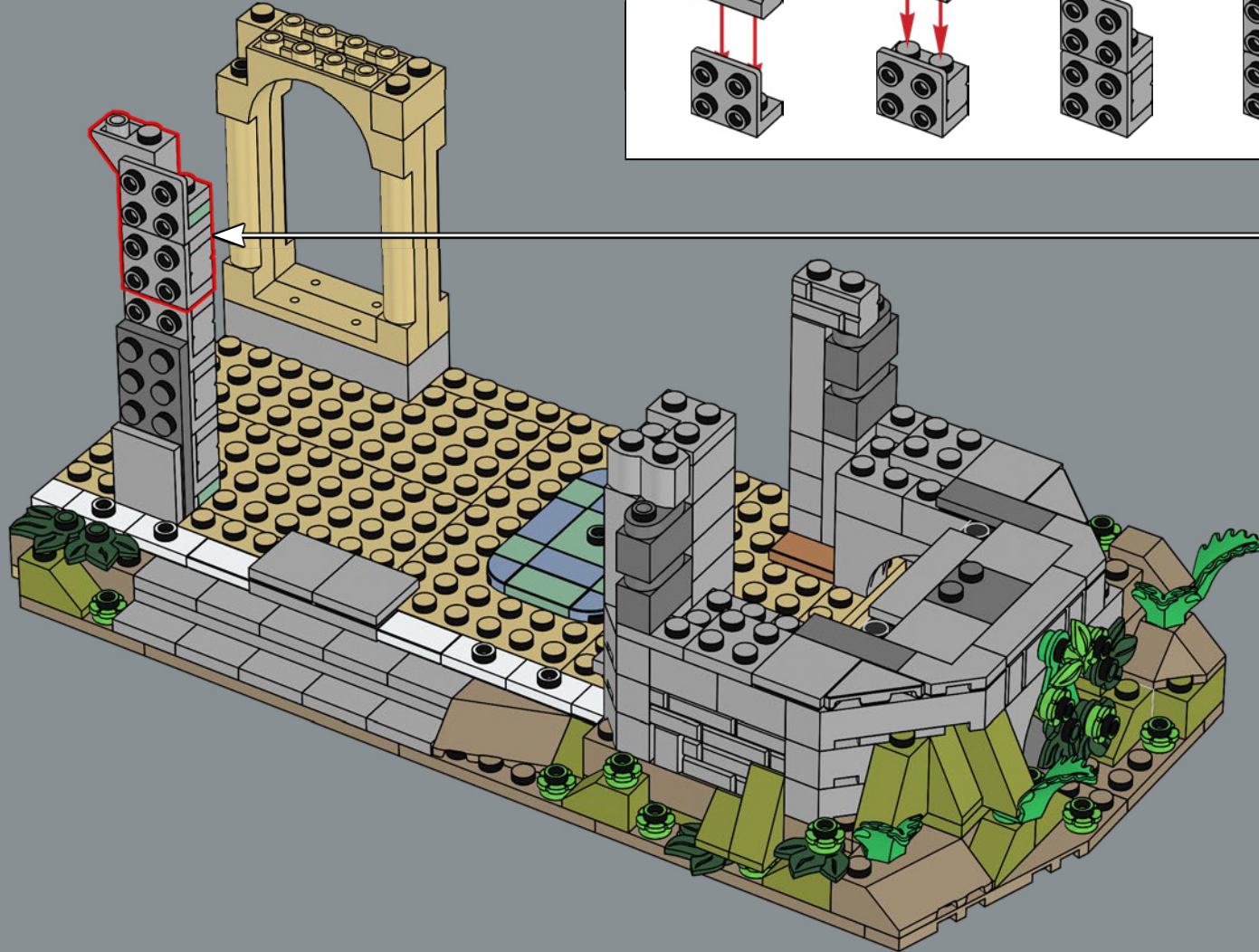

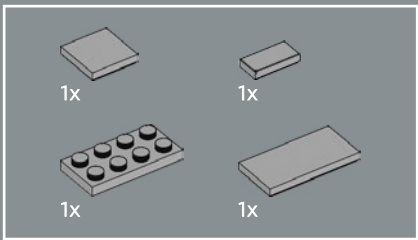

41

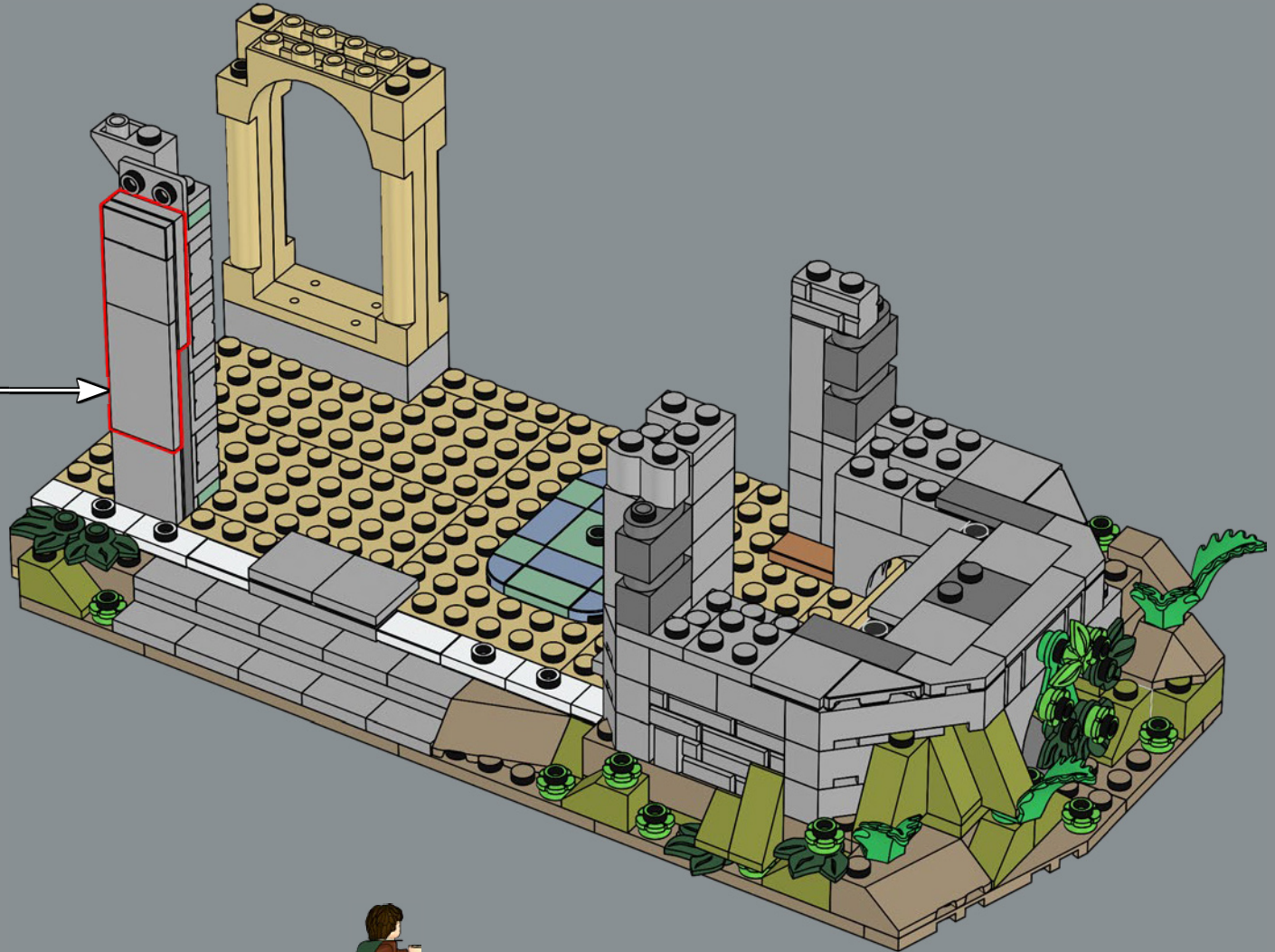
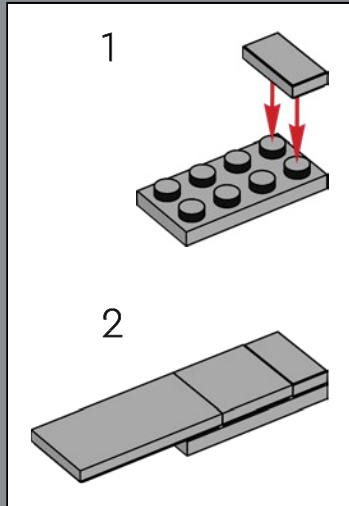

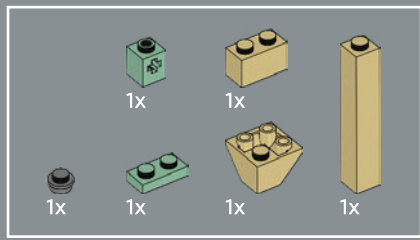

42

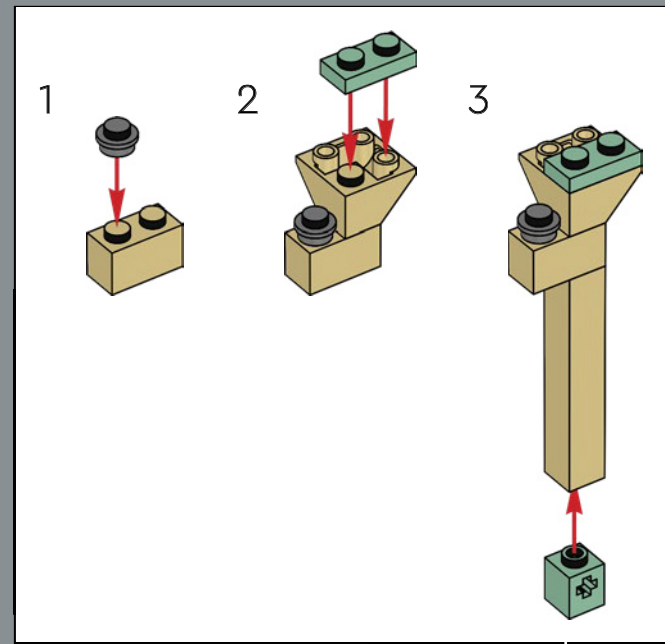
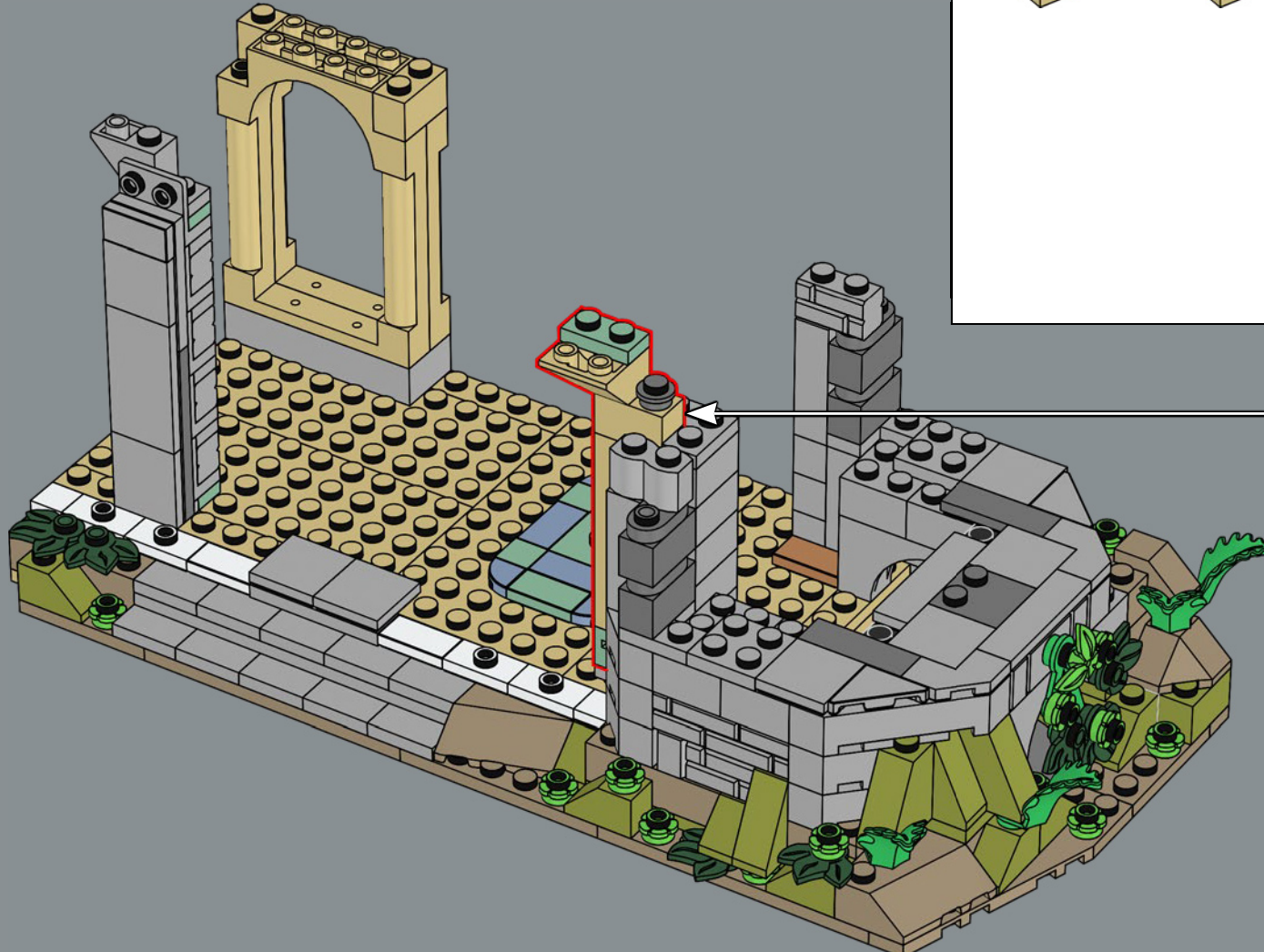

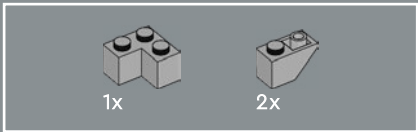

43

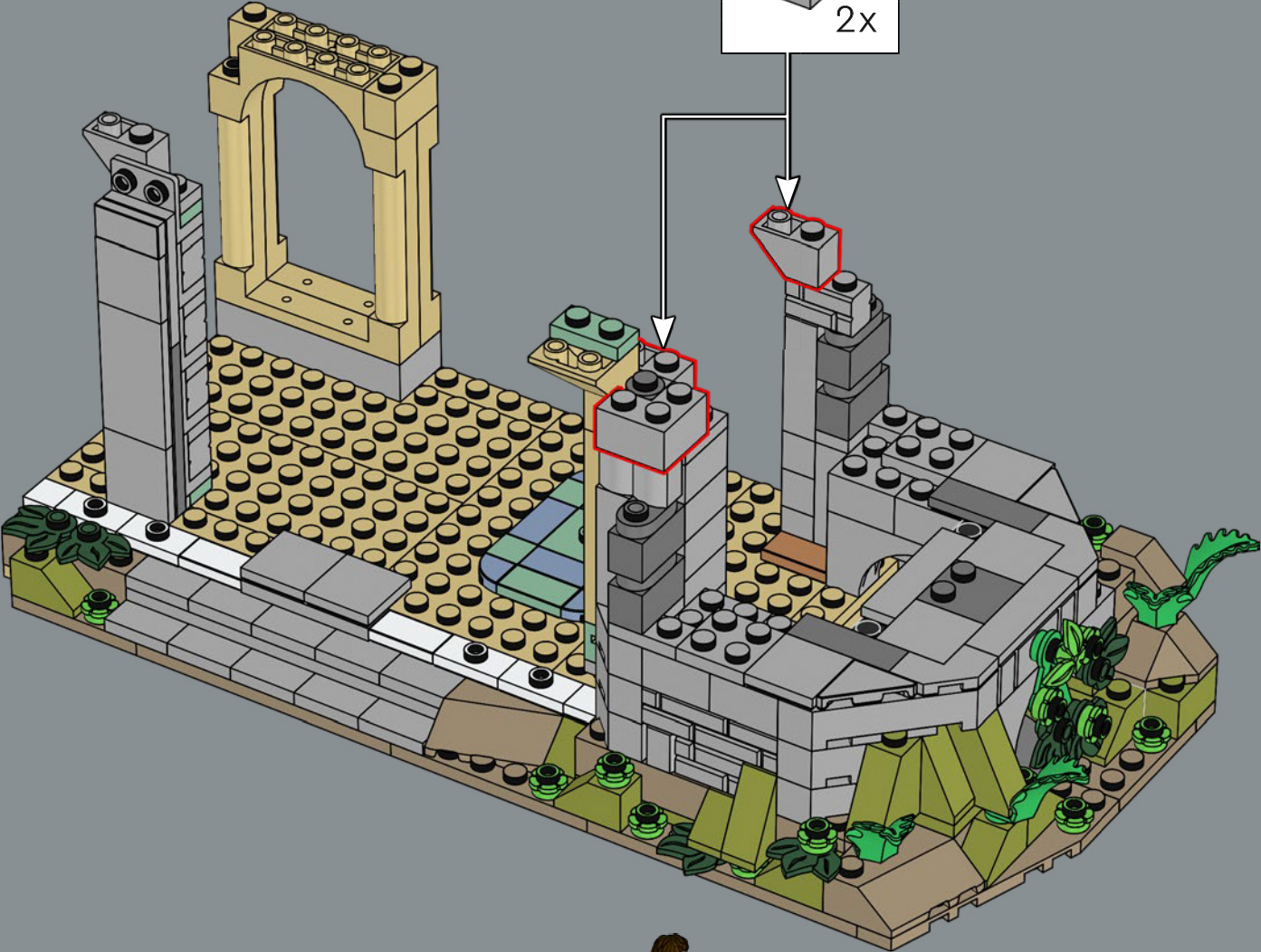
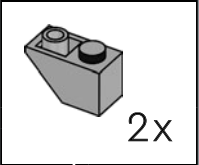

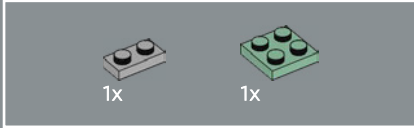
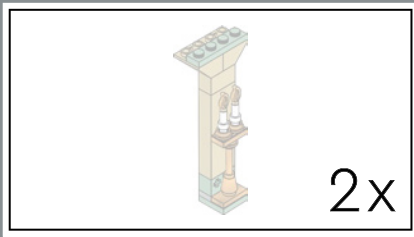

44

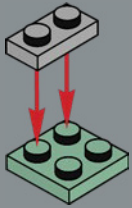

45

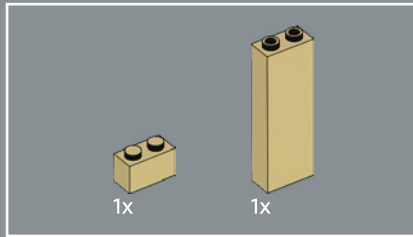
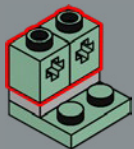

46

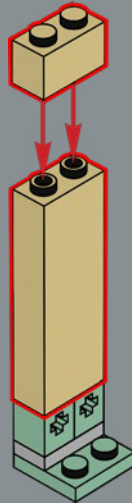

47

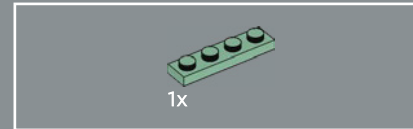
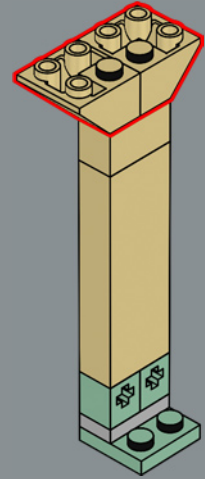

48

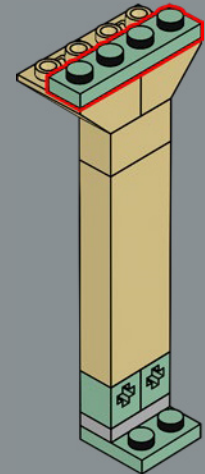

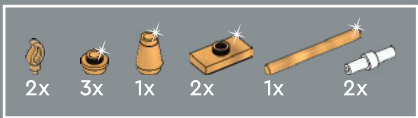

49

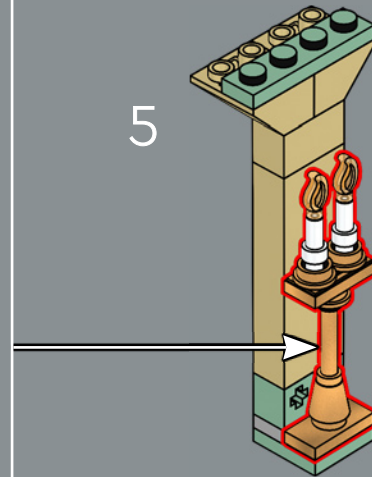
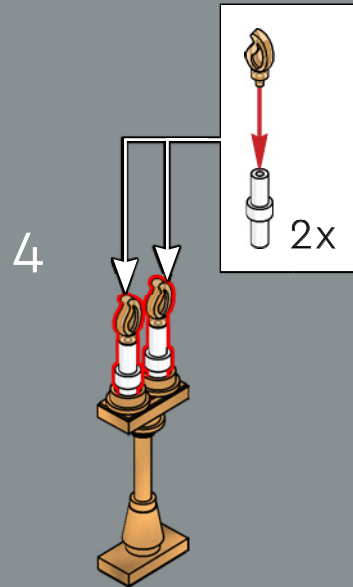
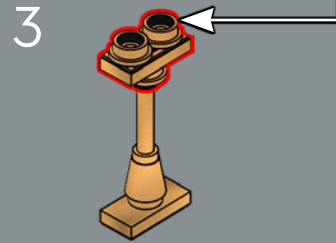
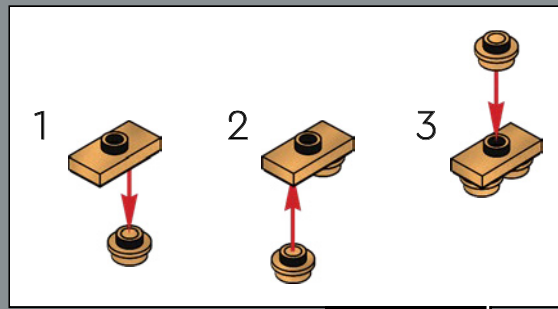
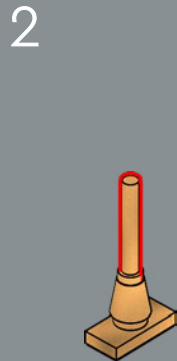
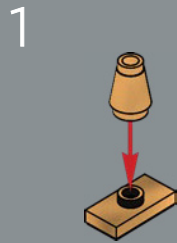

2x



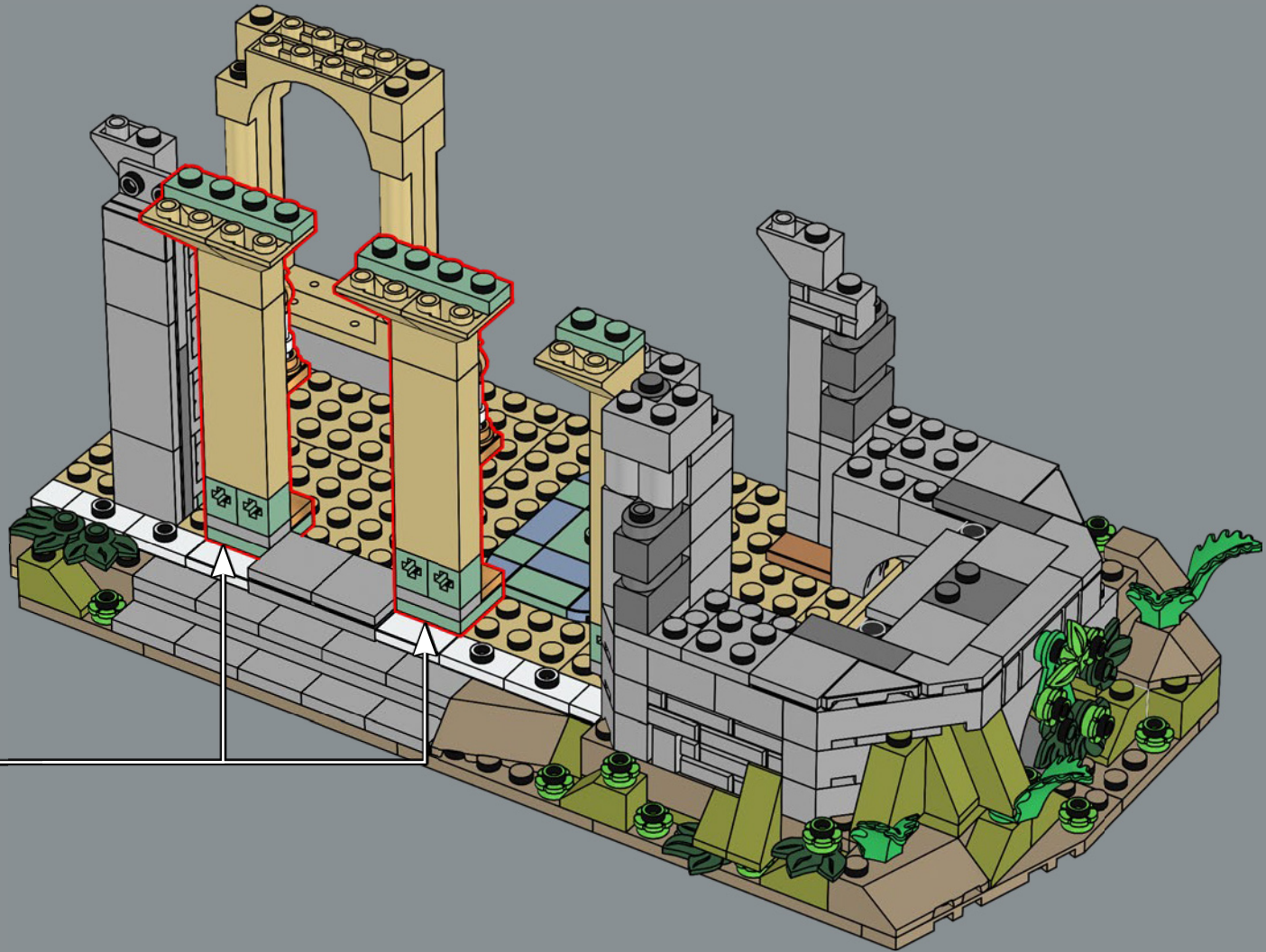

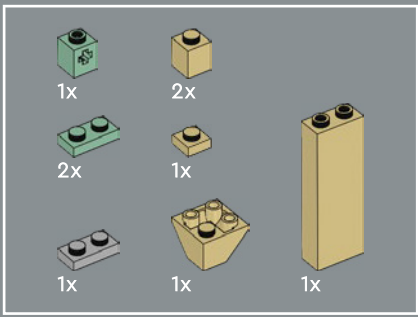

50

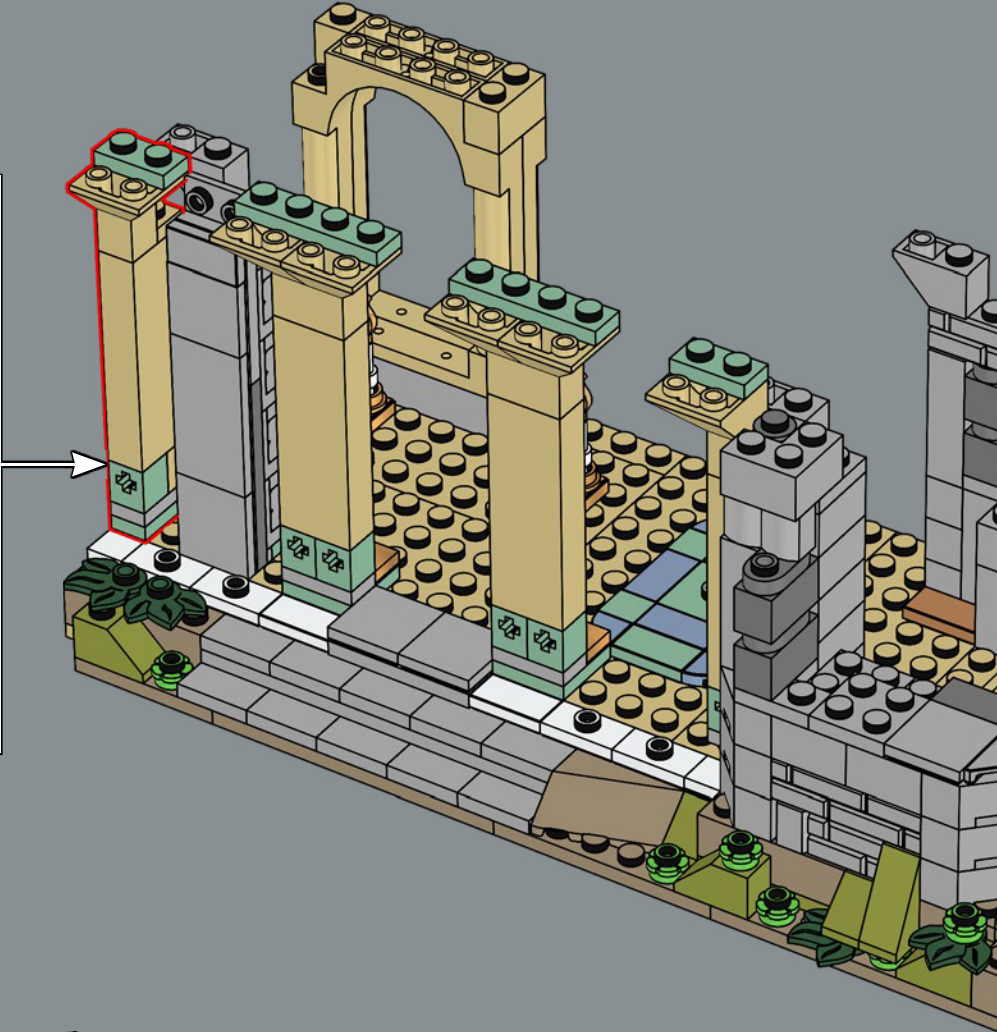
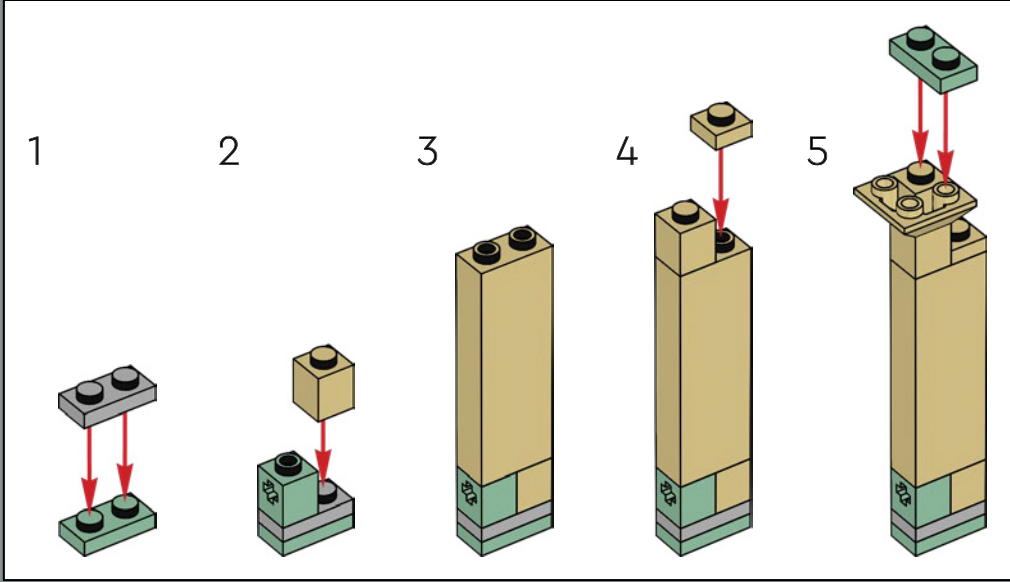

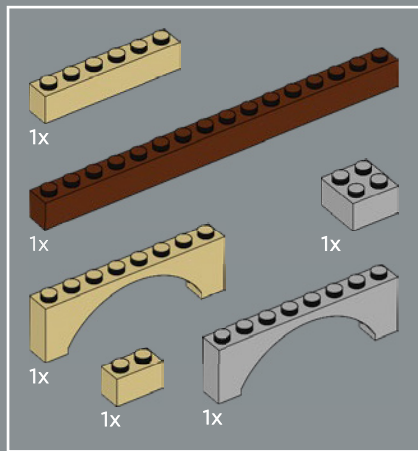

51

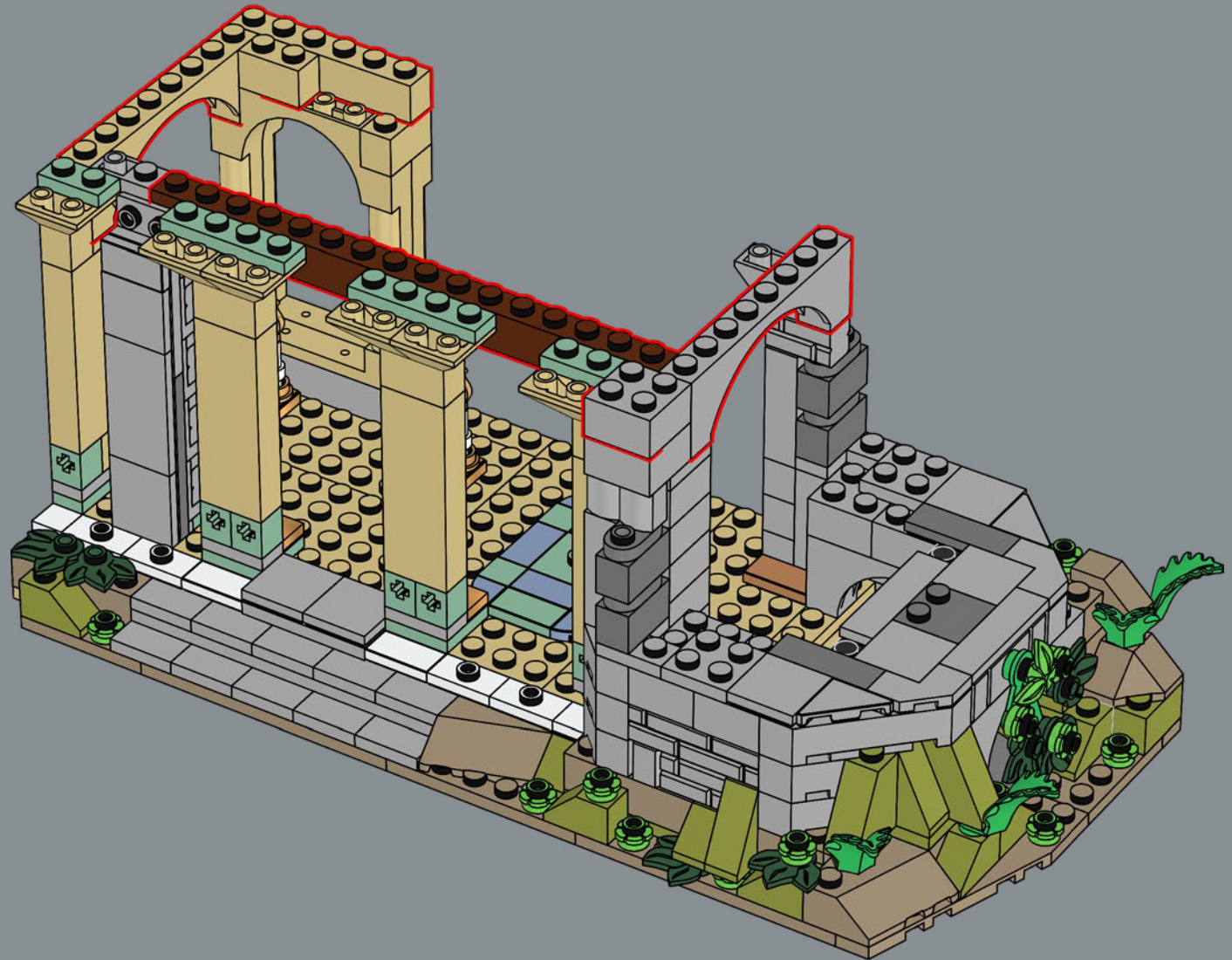

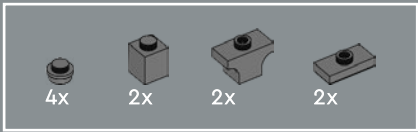

52

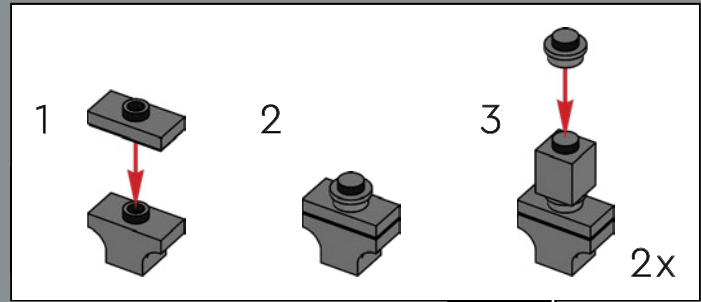
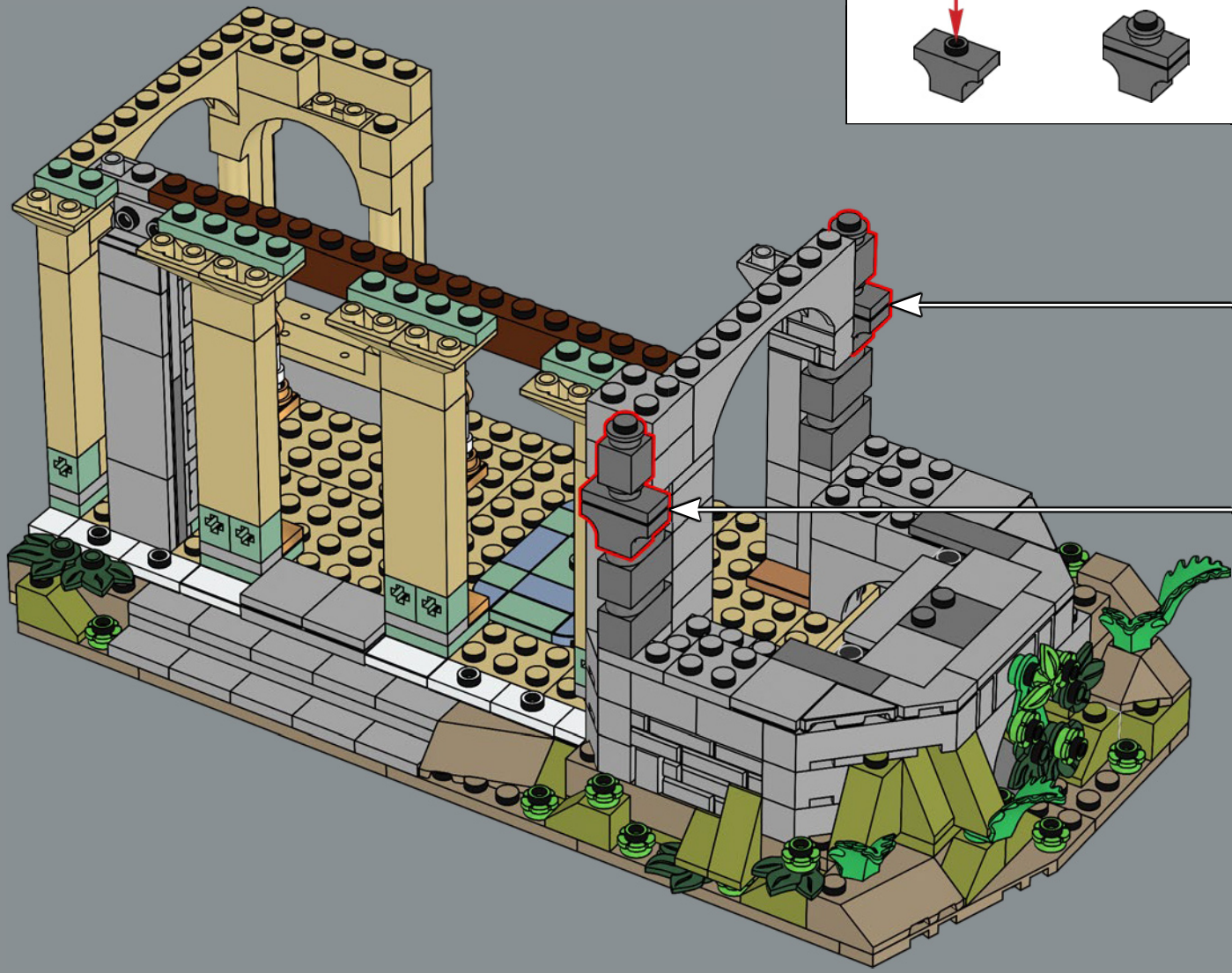

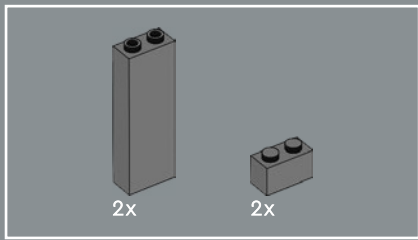

53

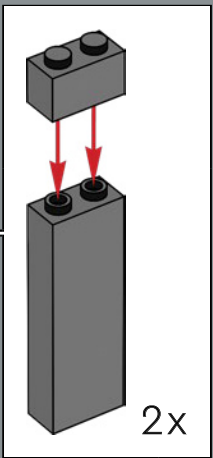
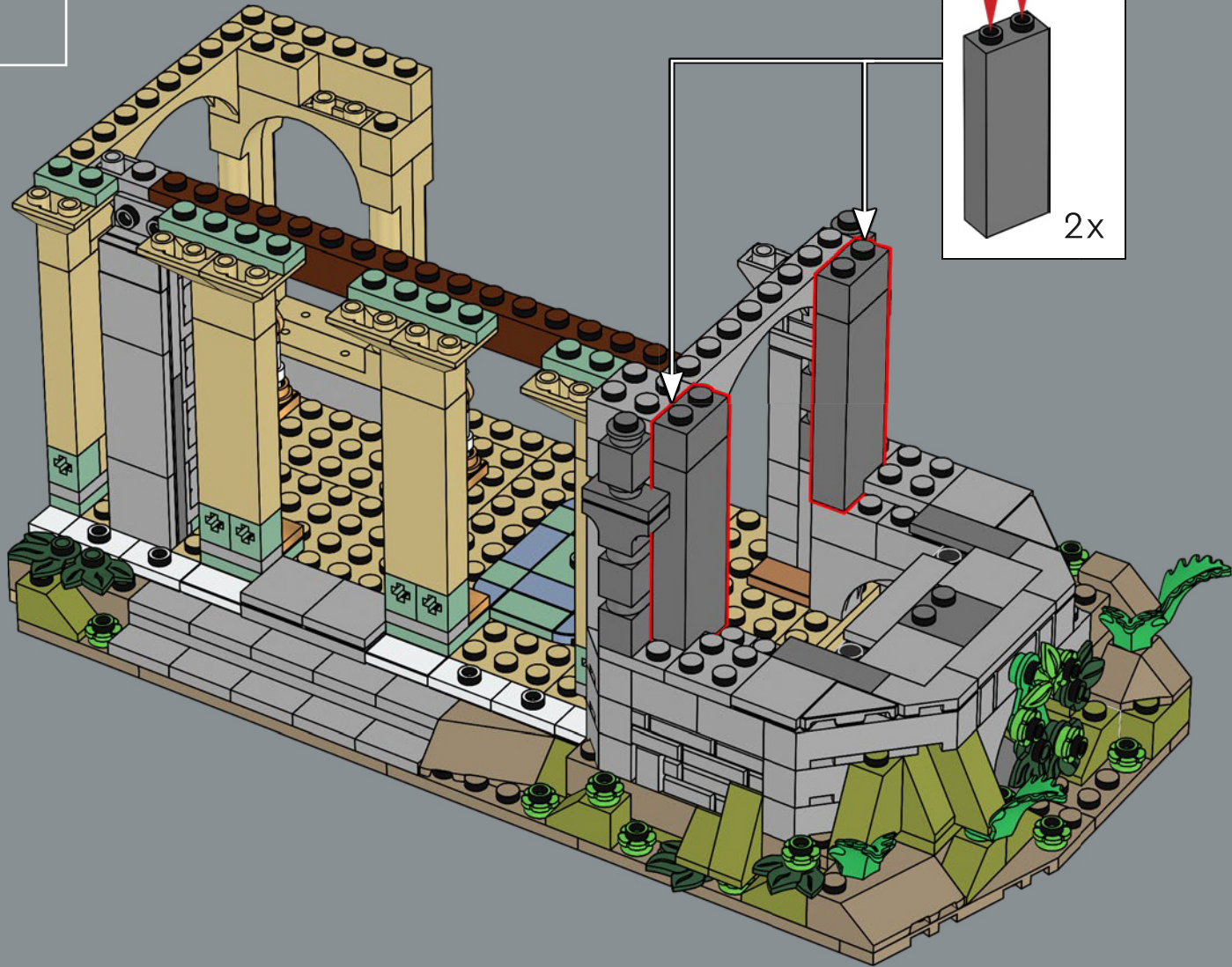



4x

54

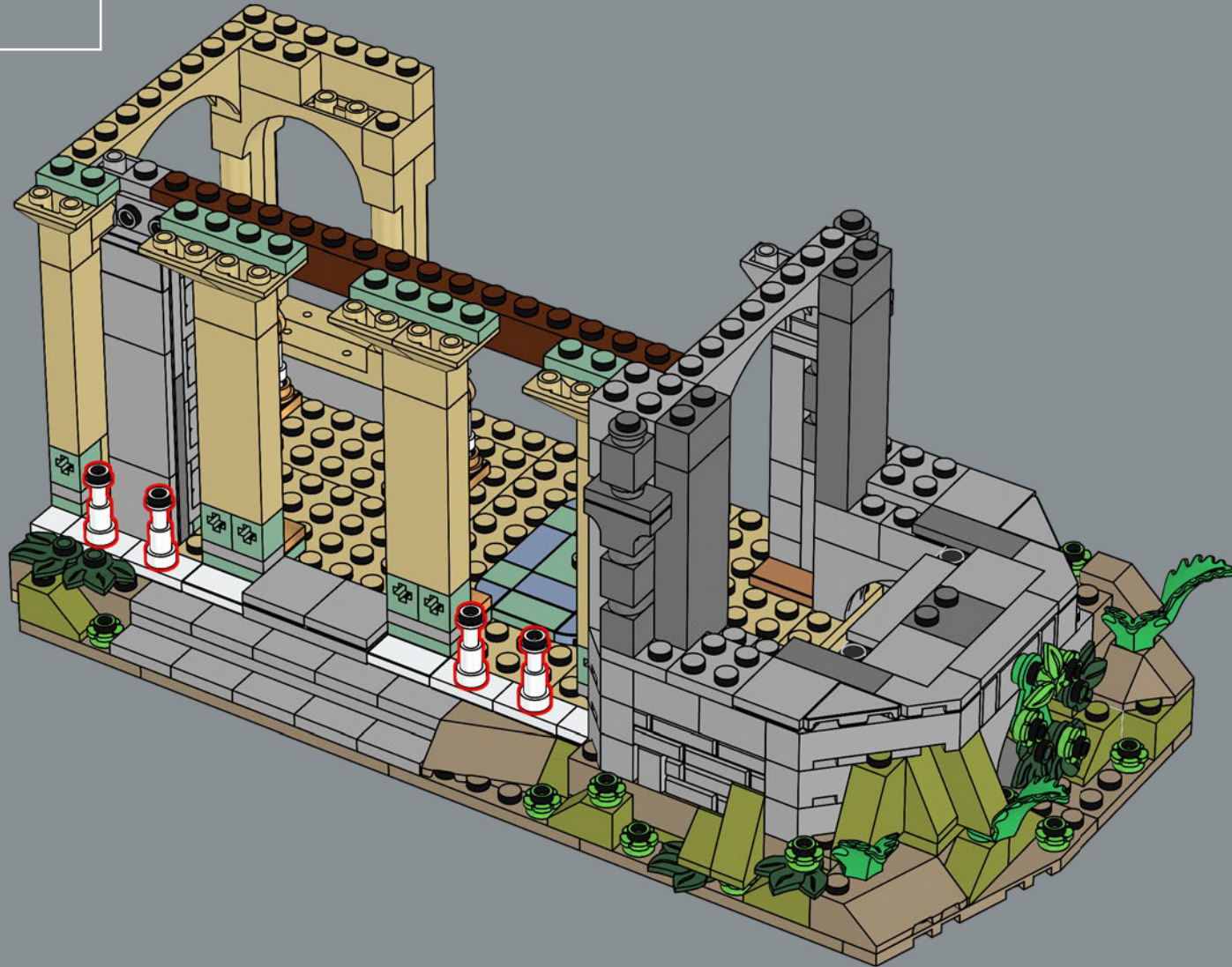

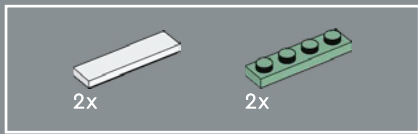

55

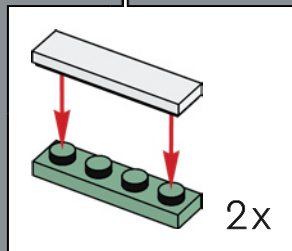
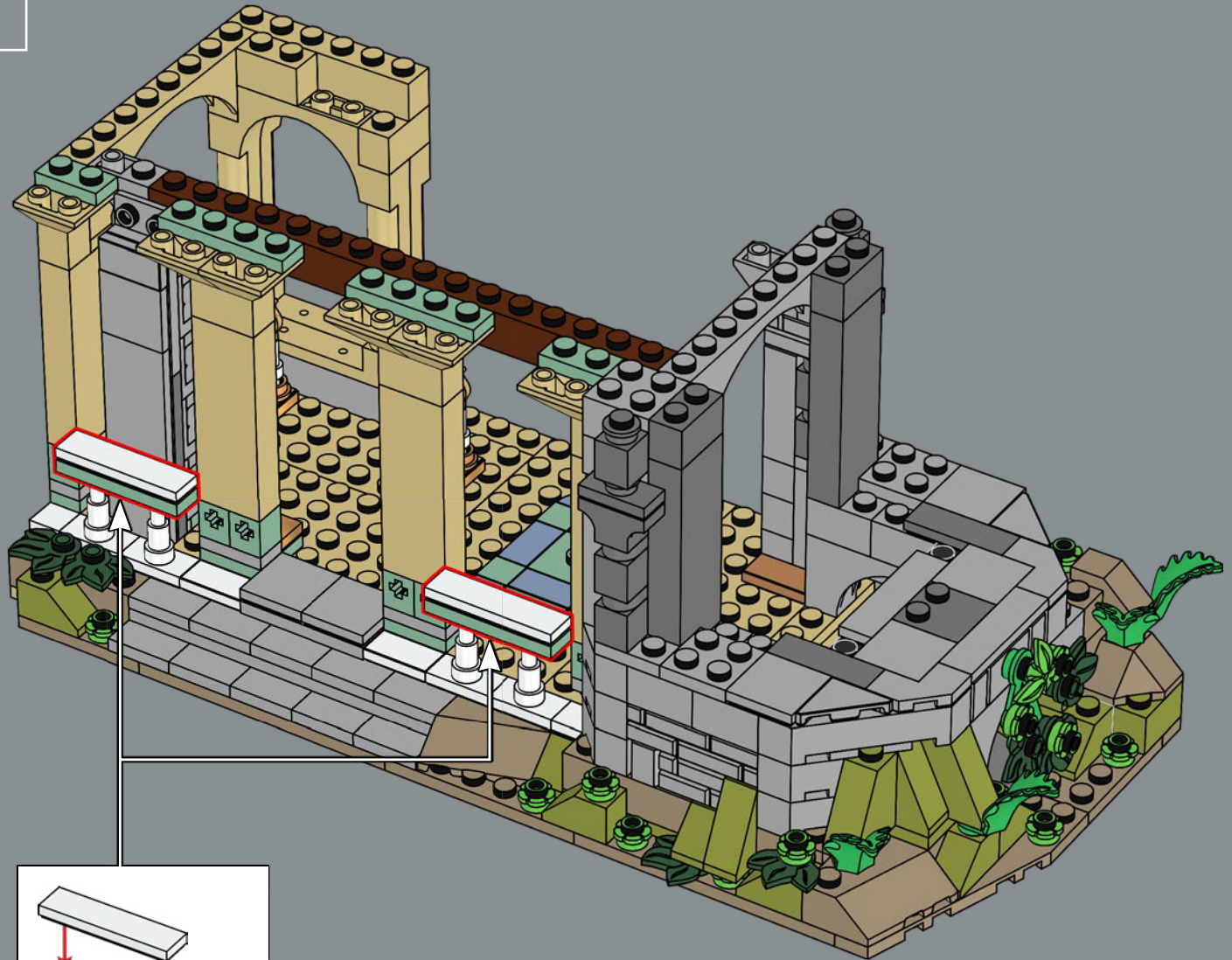

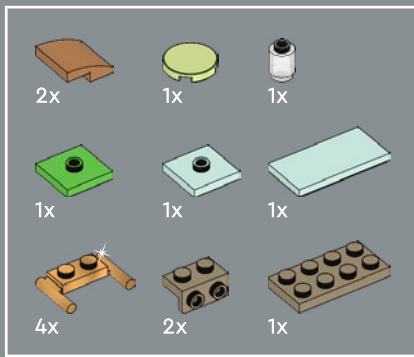

56

1



2

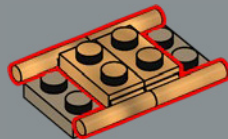

3

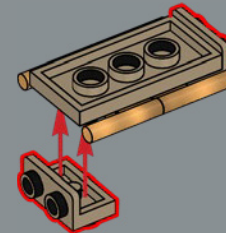

4

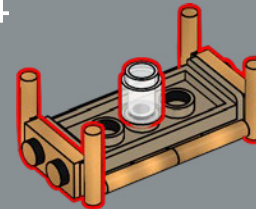

5

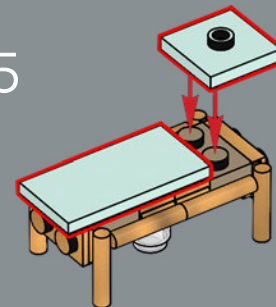

6

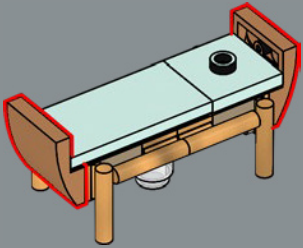

7

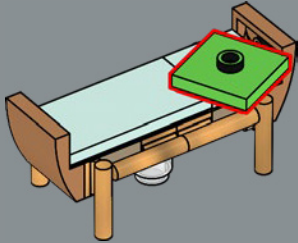

8

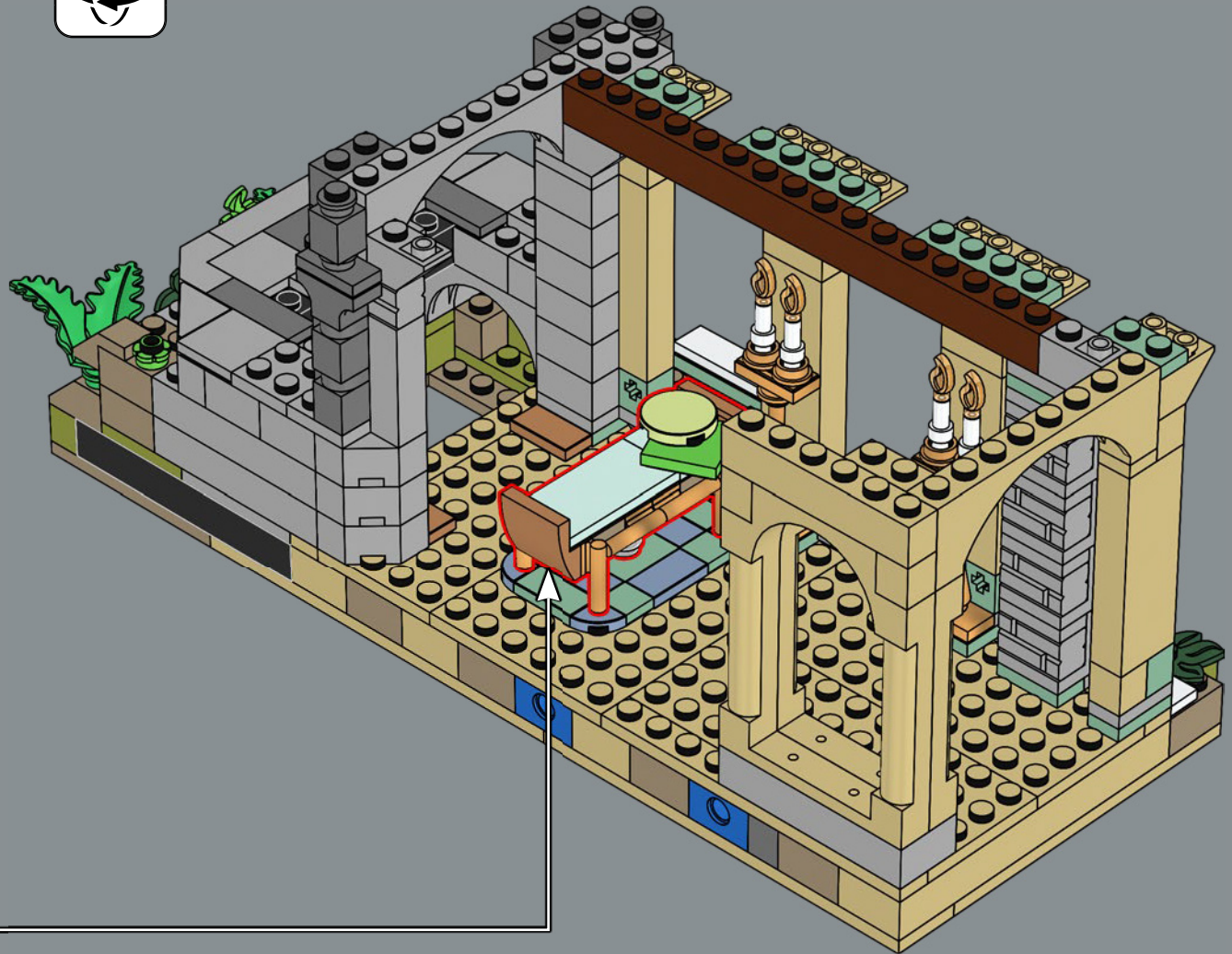
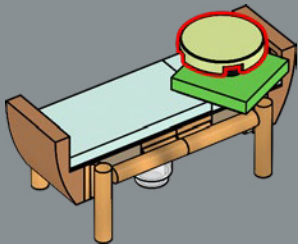

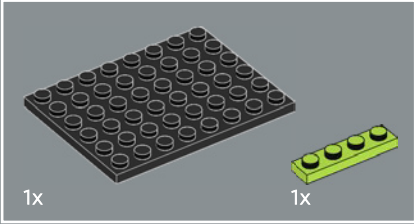
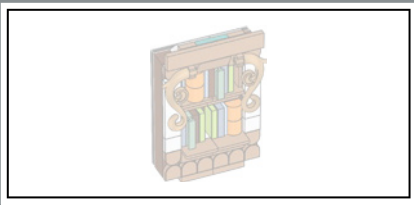

57

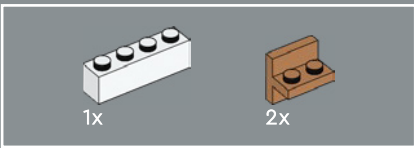
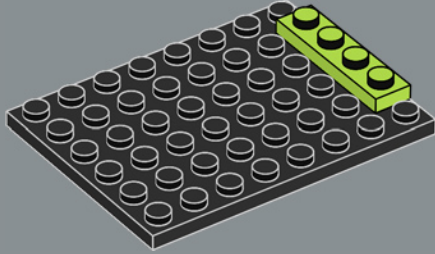

58

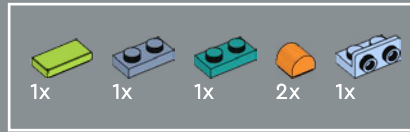
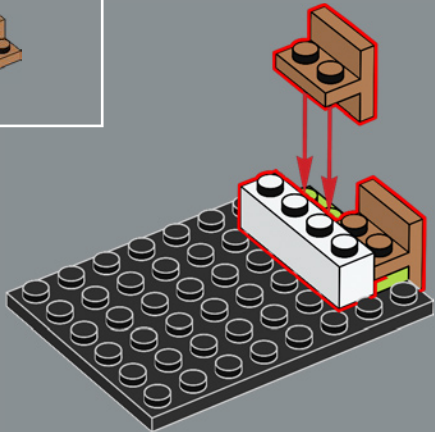

59

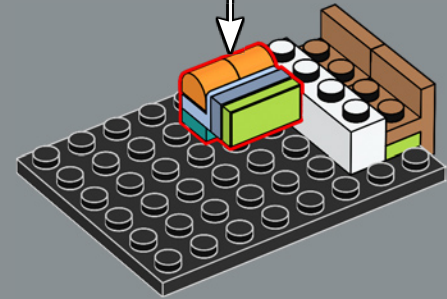
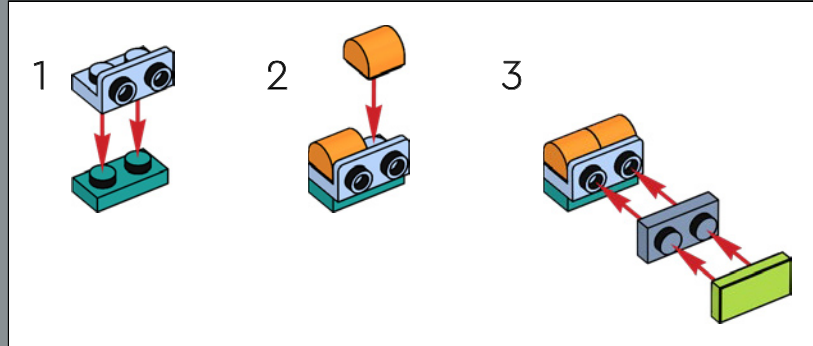

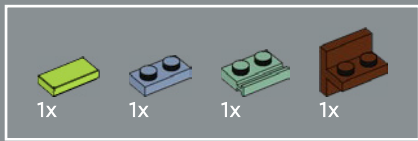

60

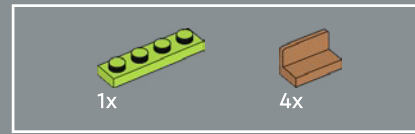
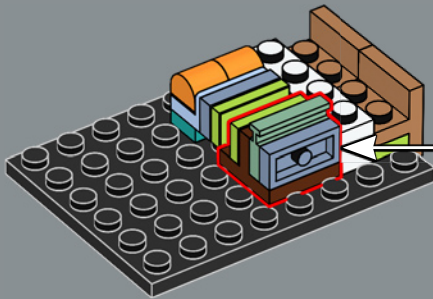
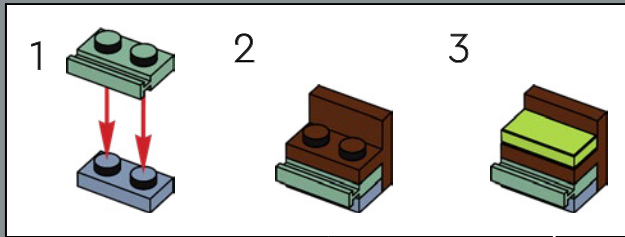

61

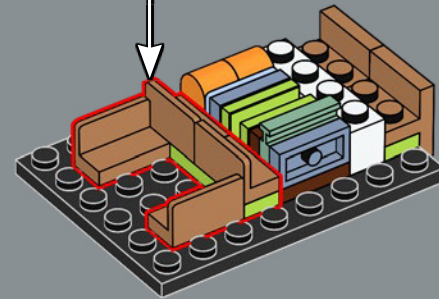
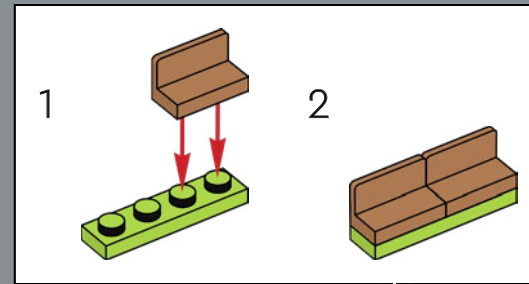

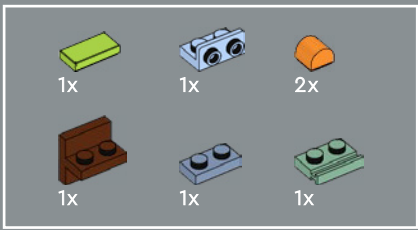

62

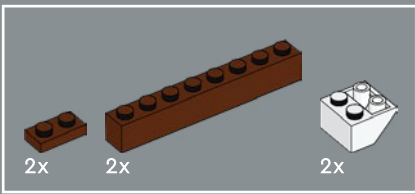
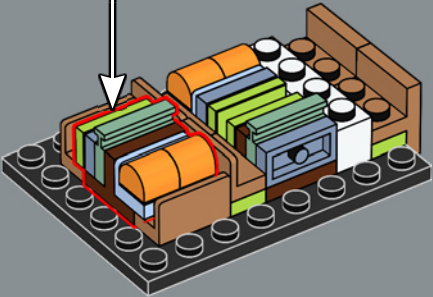
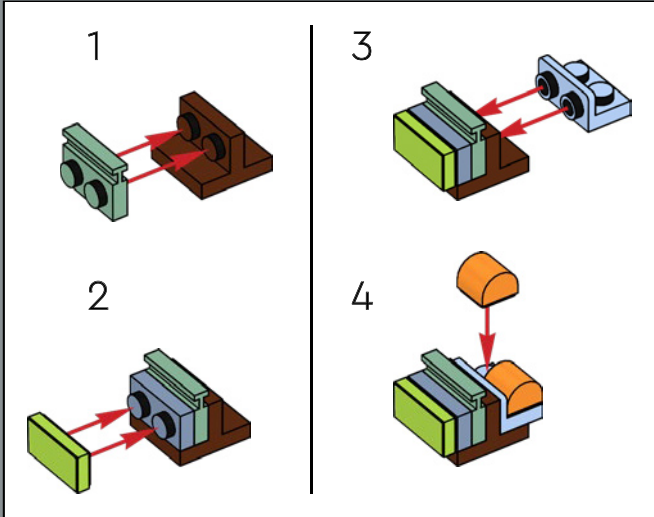

63

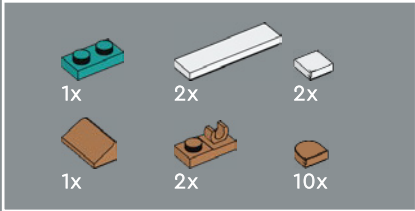
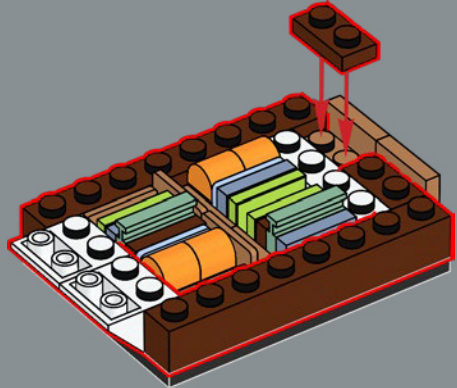

64

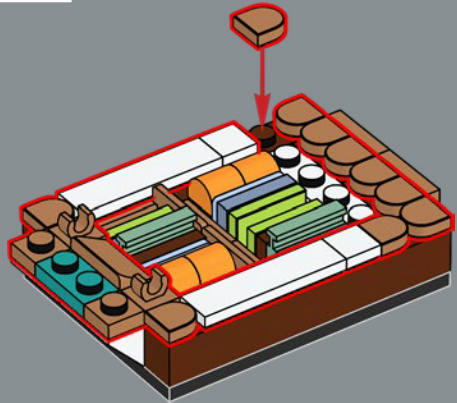

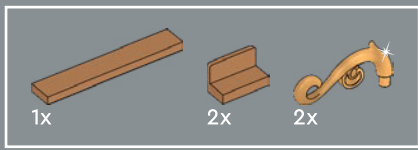

65

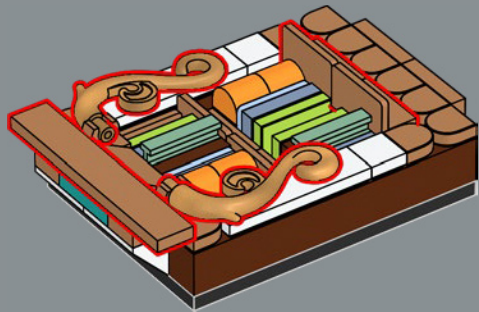

66

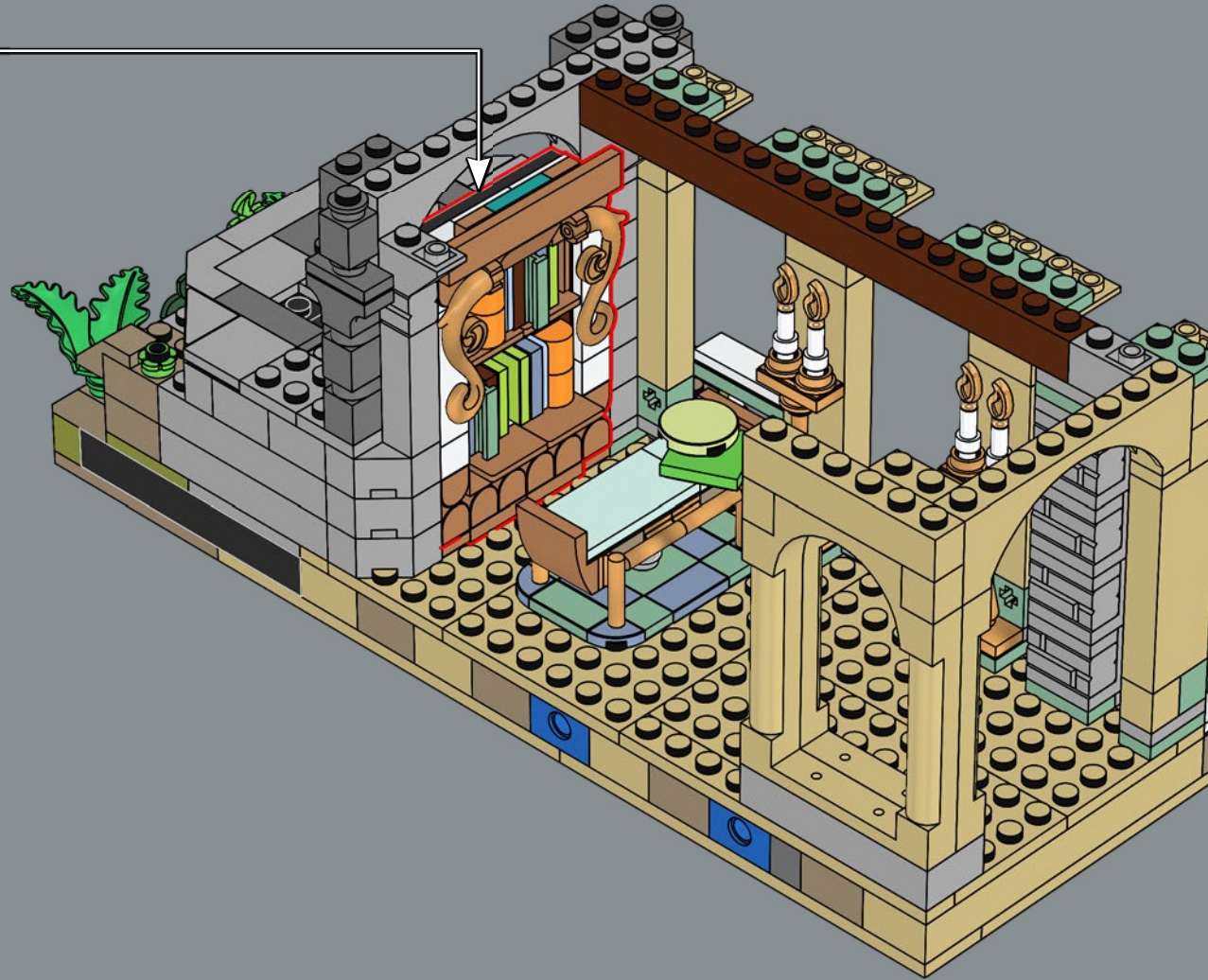

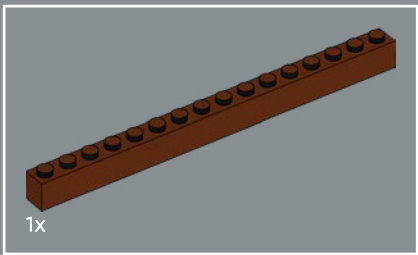

67



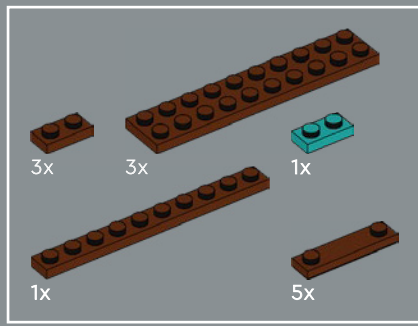

68

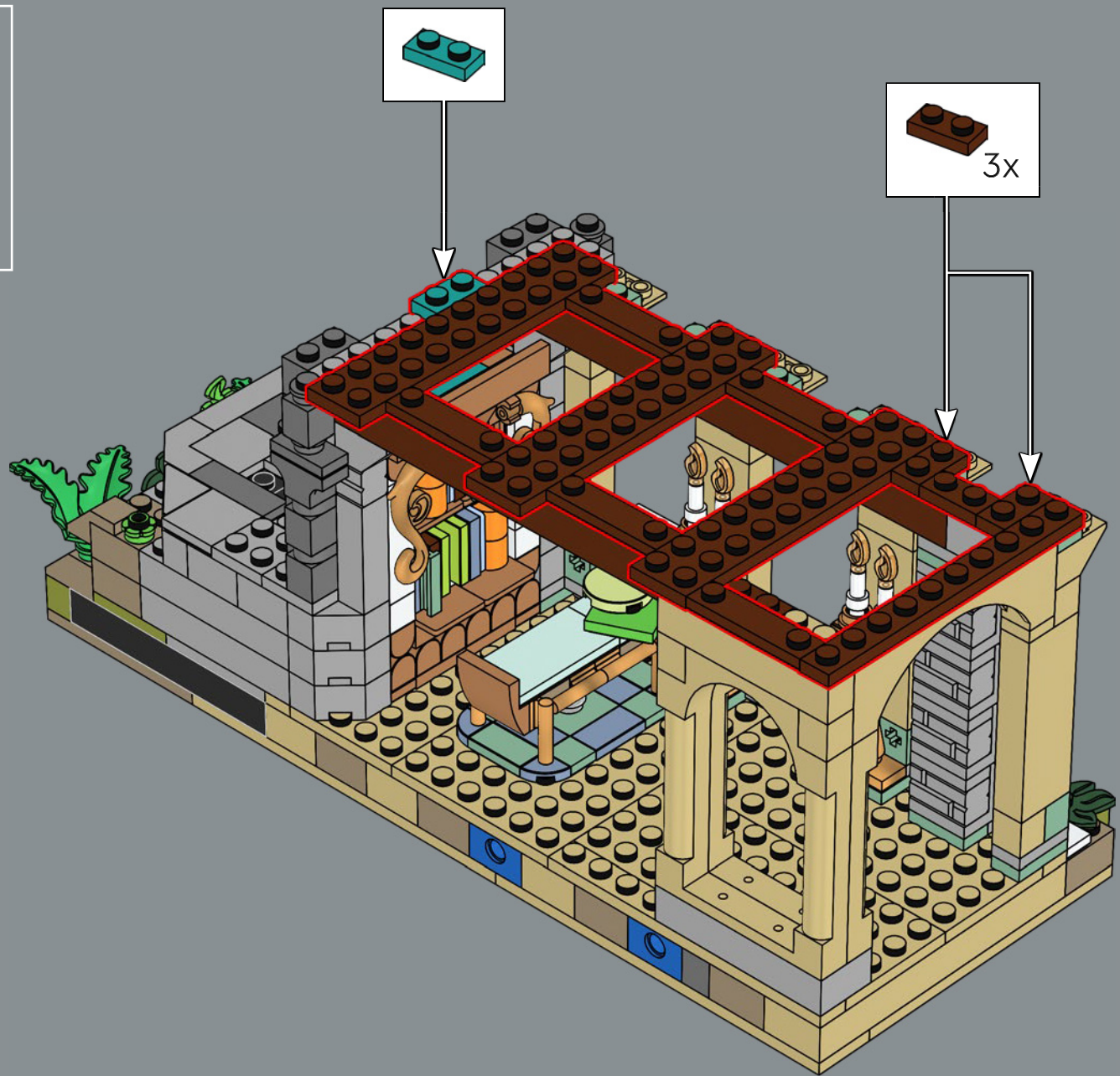

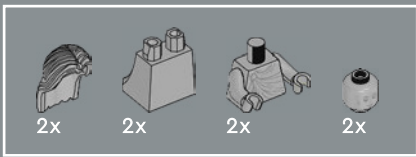

69

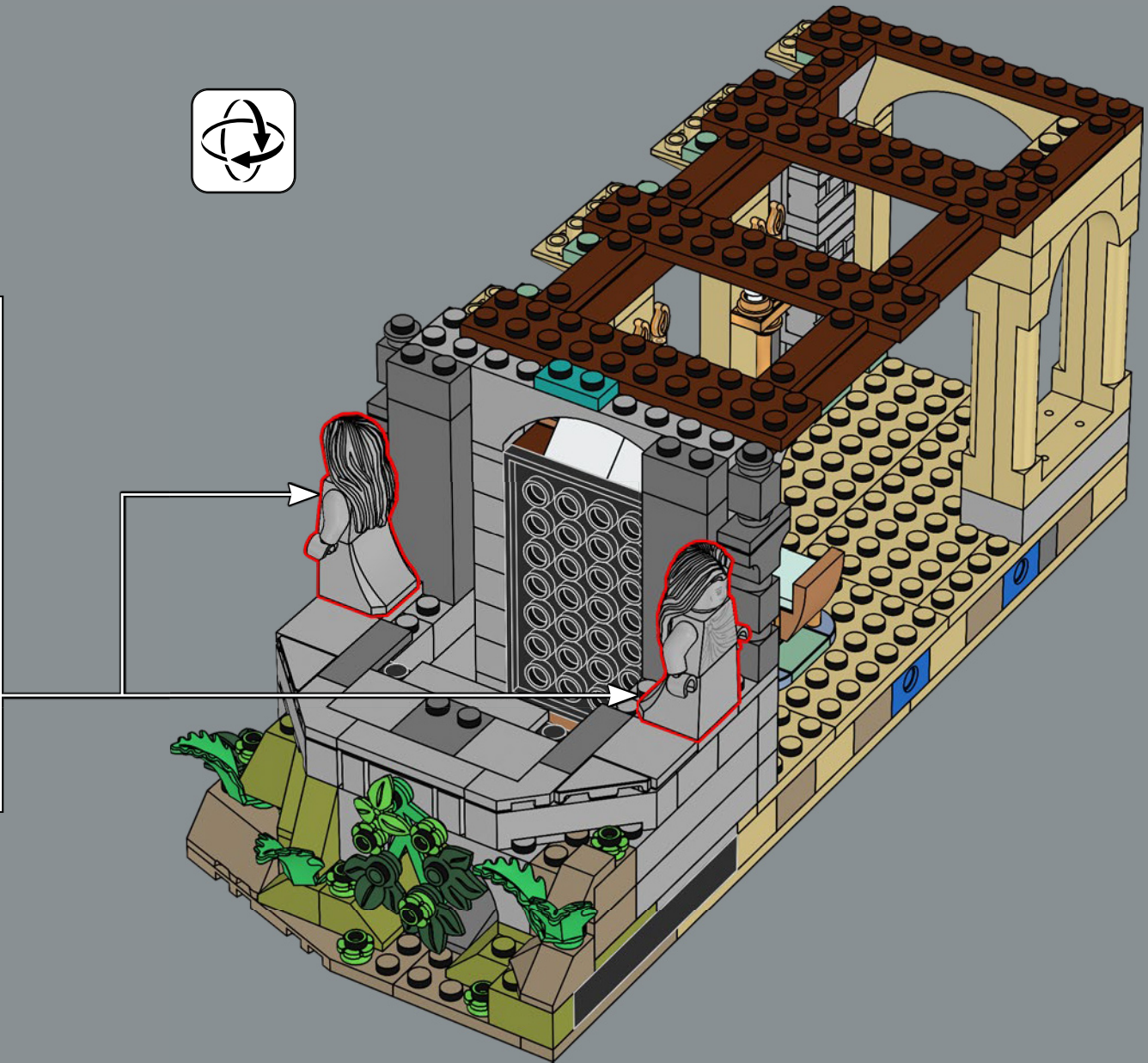
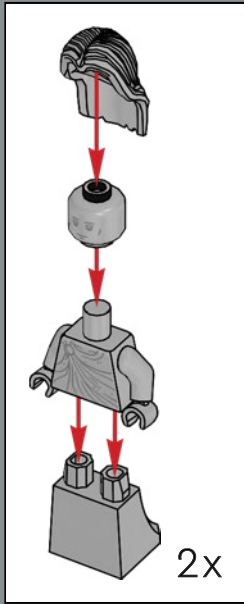

Les statues présentent deux nouvelles expressions :
un visage impassible et un regard dur !





70

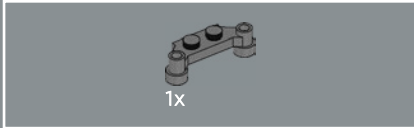
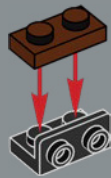

71

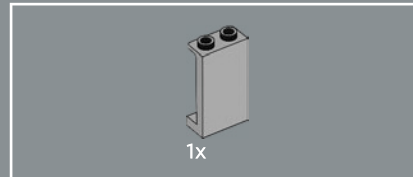
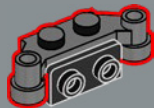

72

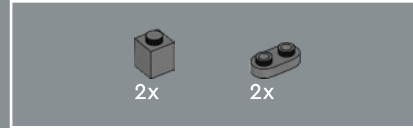
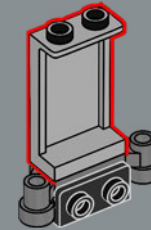

73

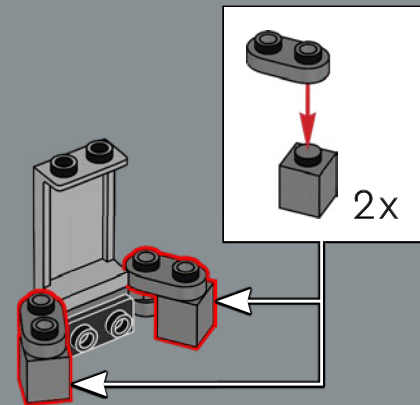



2x

74

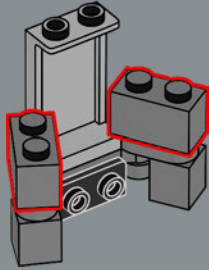

2x

75

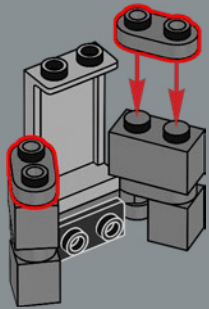

2x



2x

76

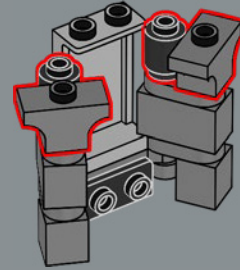

1x

77

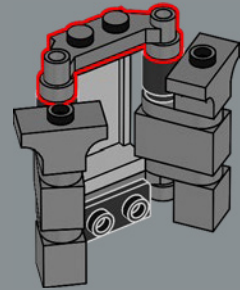

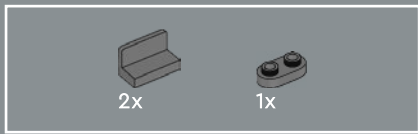

78

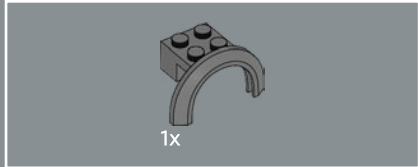
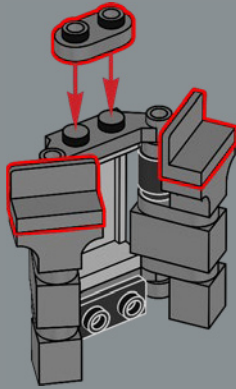

79

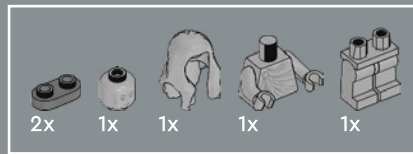
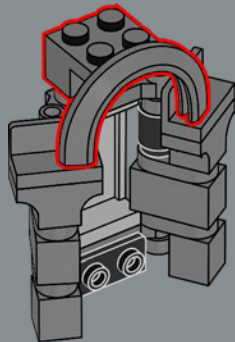

80

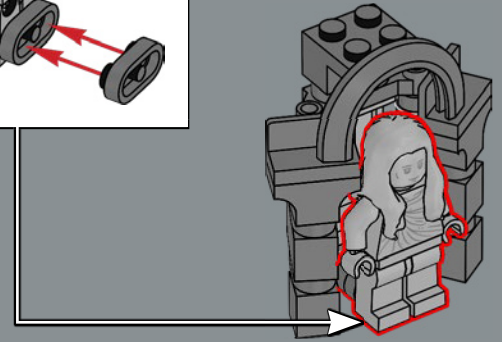
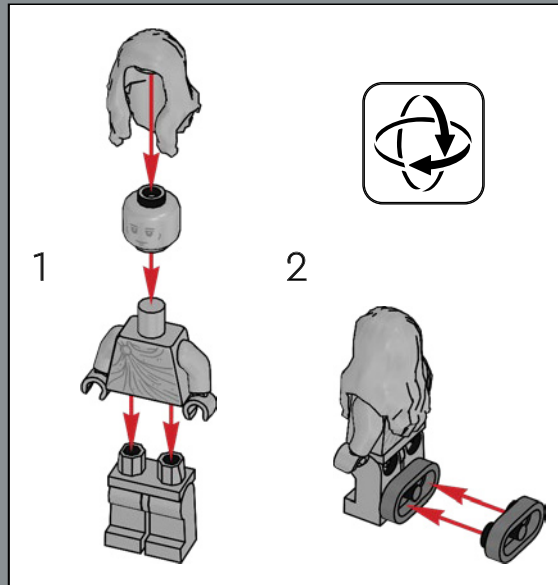



1x

81

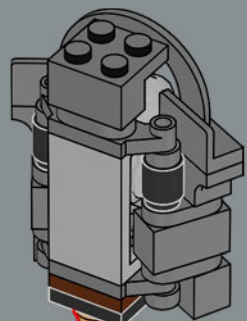

2x



82

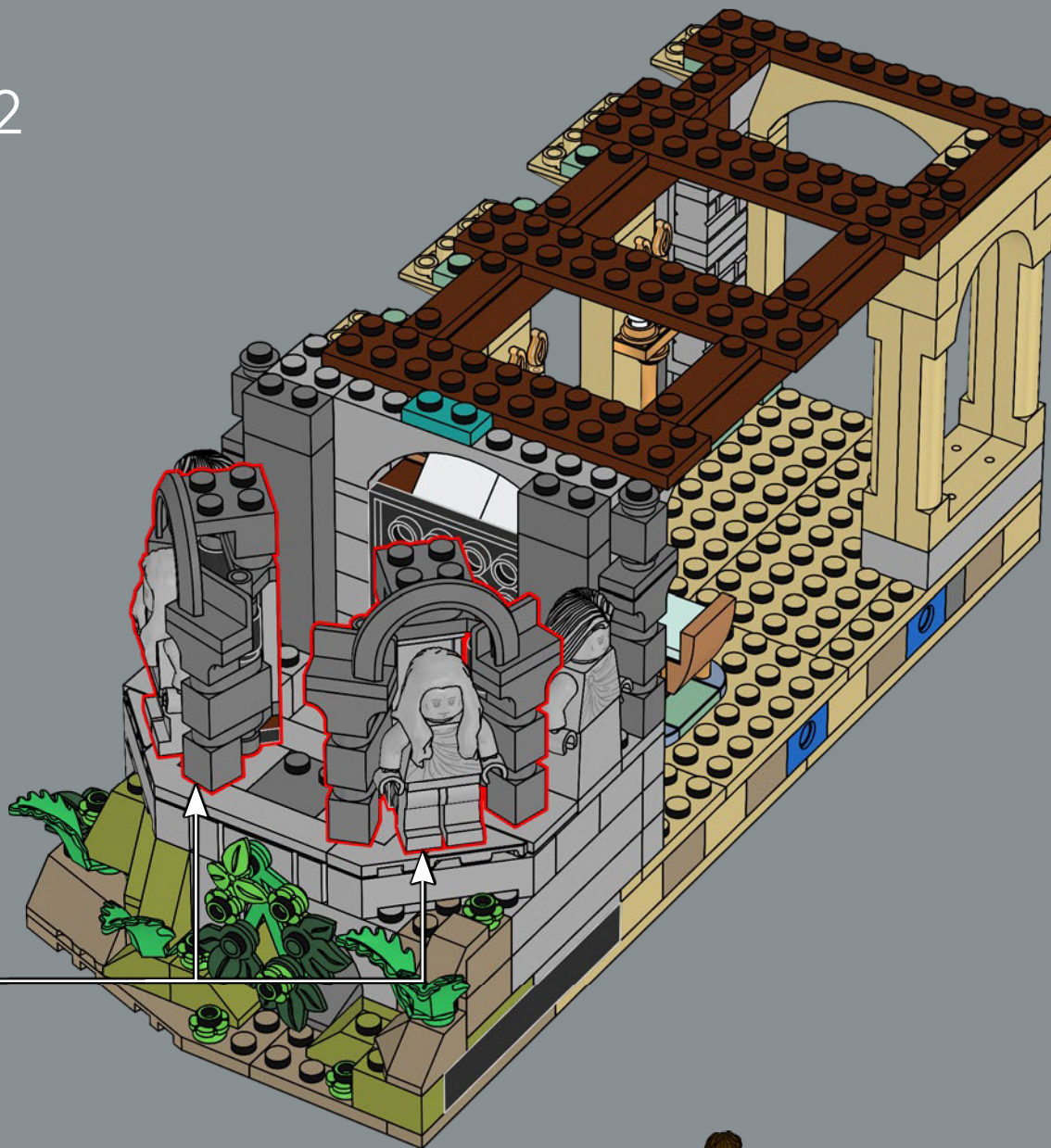

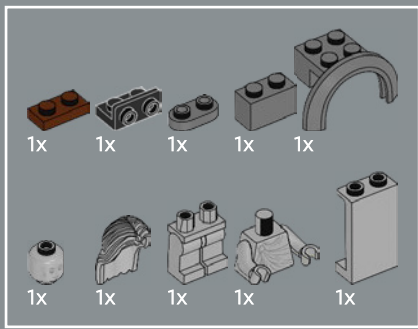

83

1

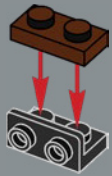

2

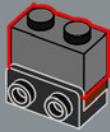

3

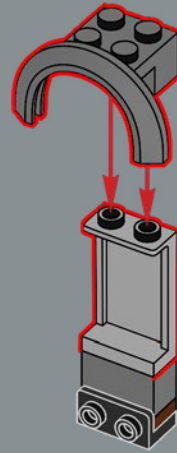

4

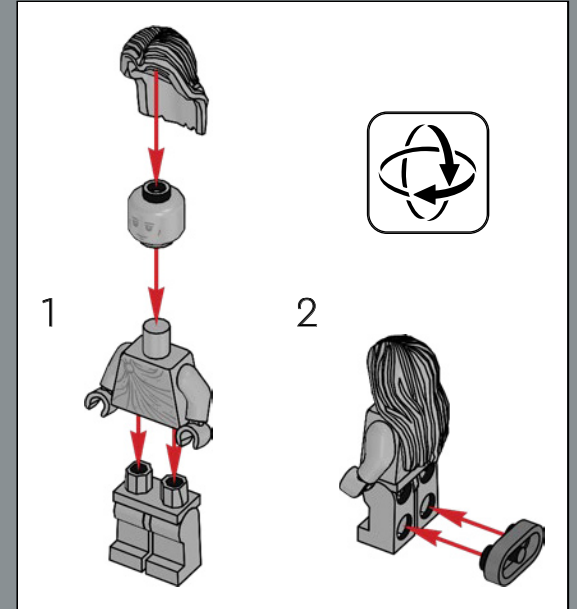

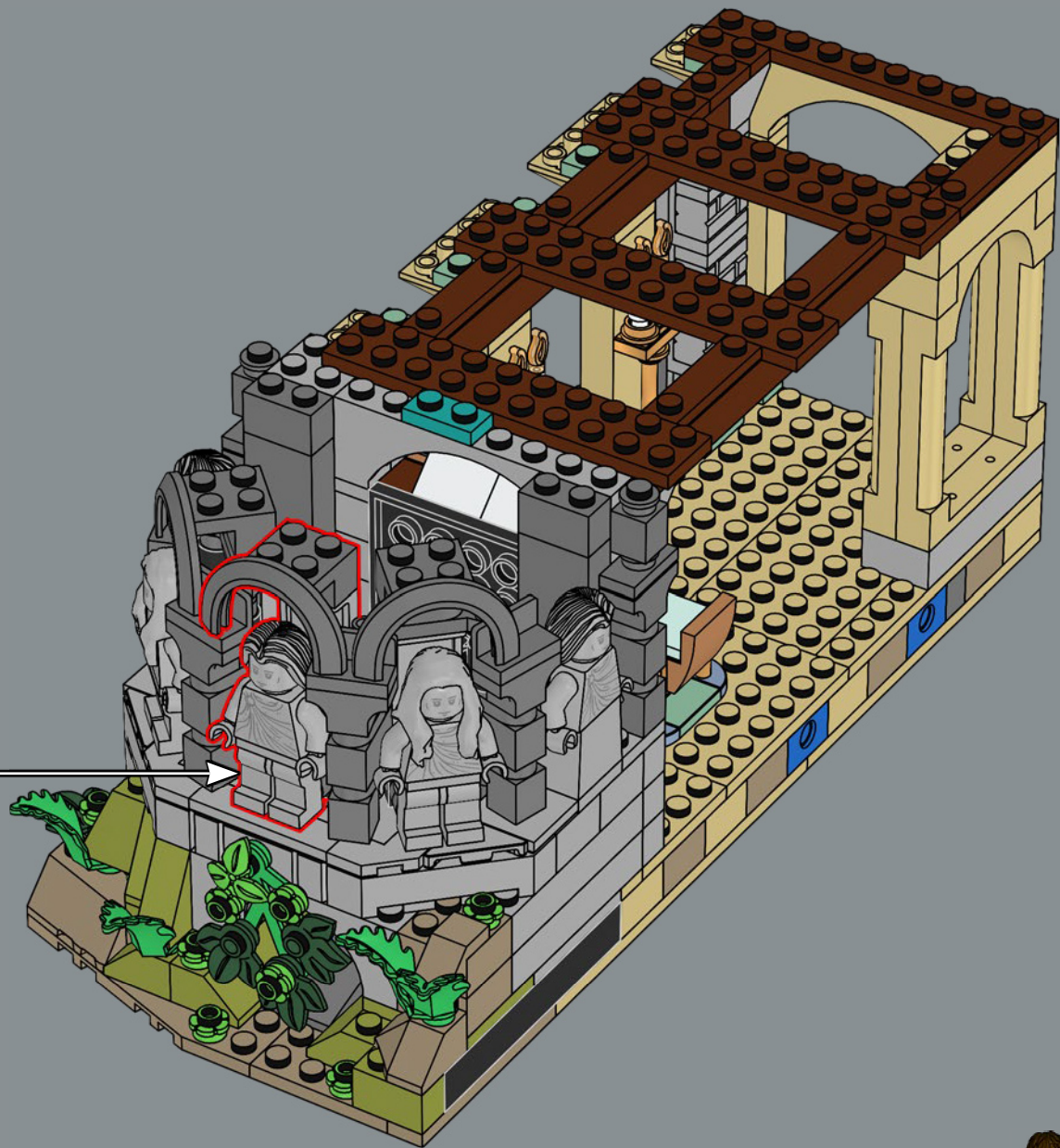

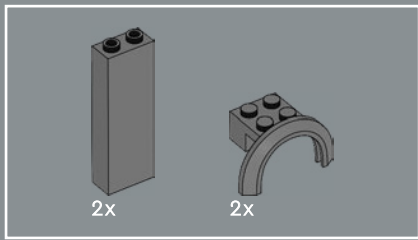

84

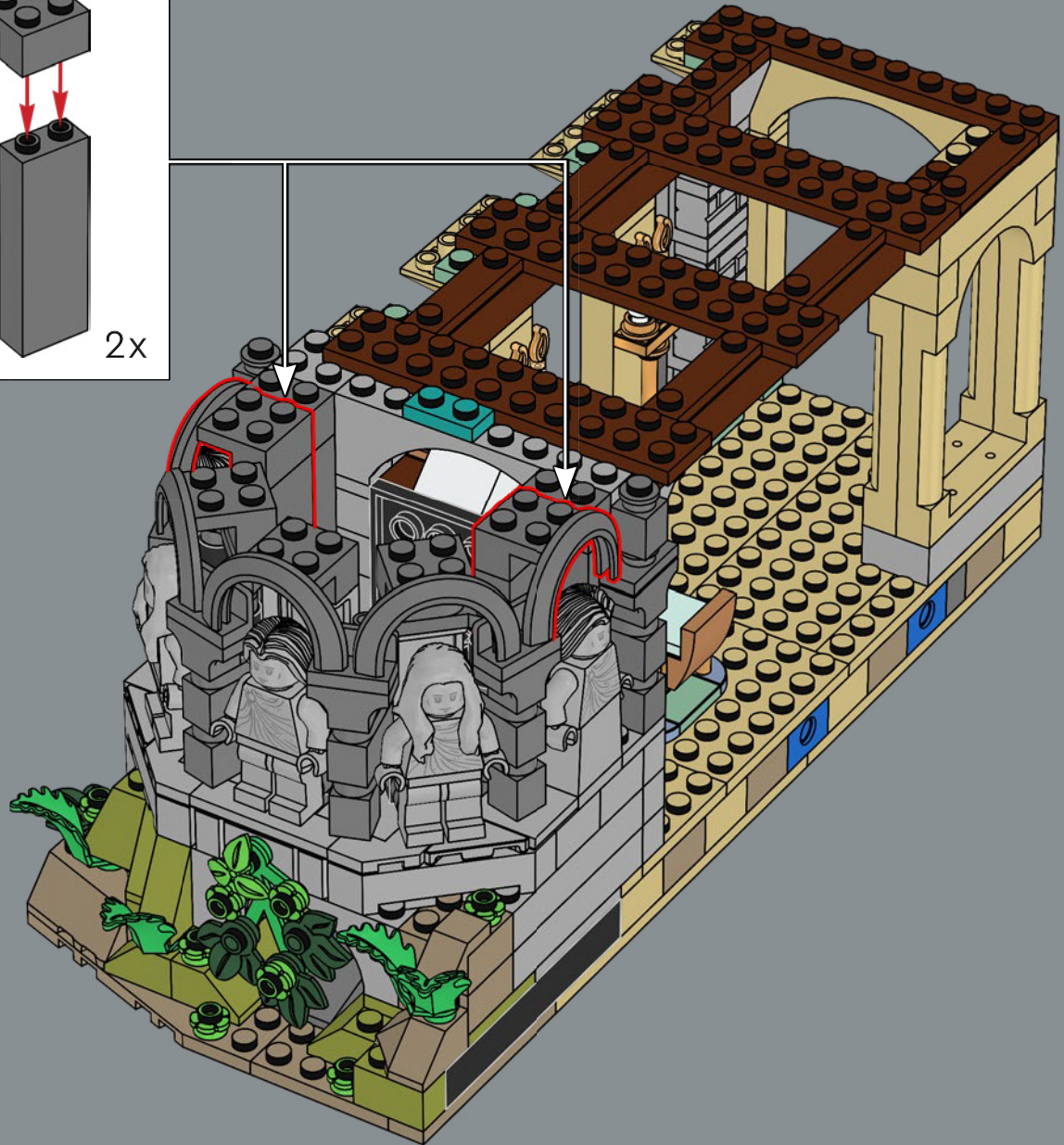
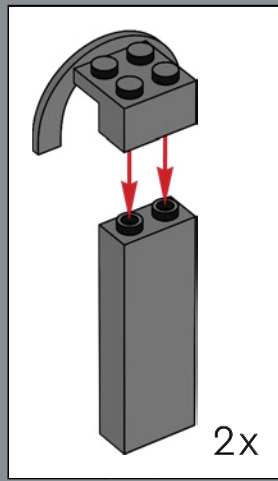

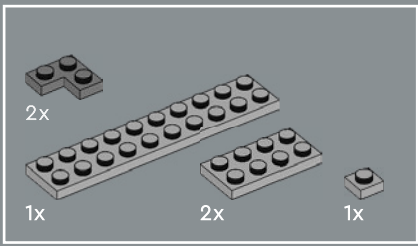

85

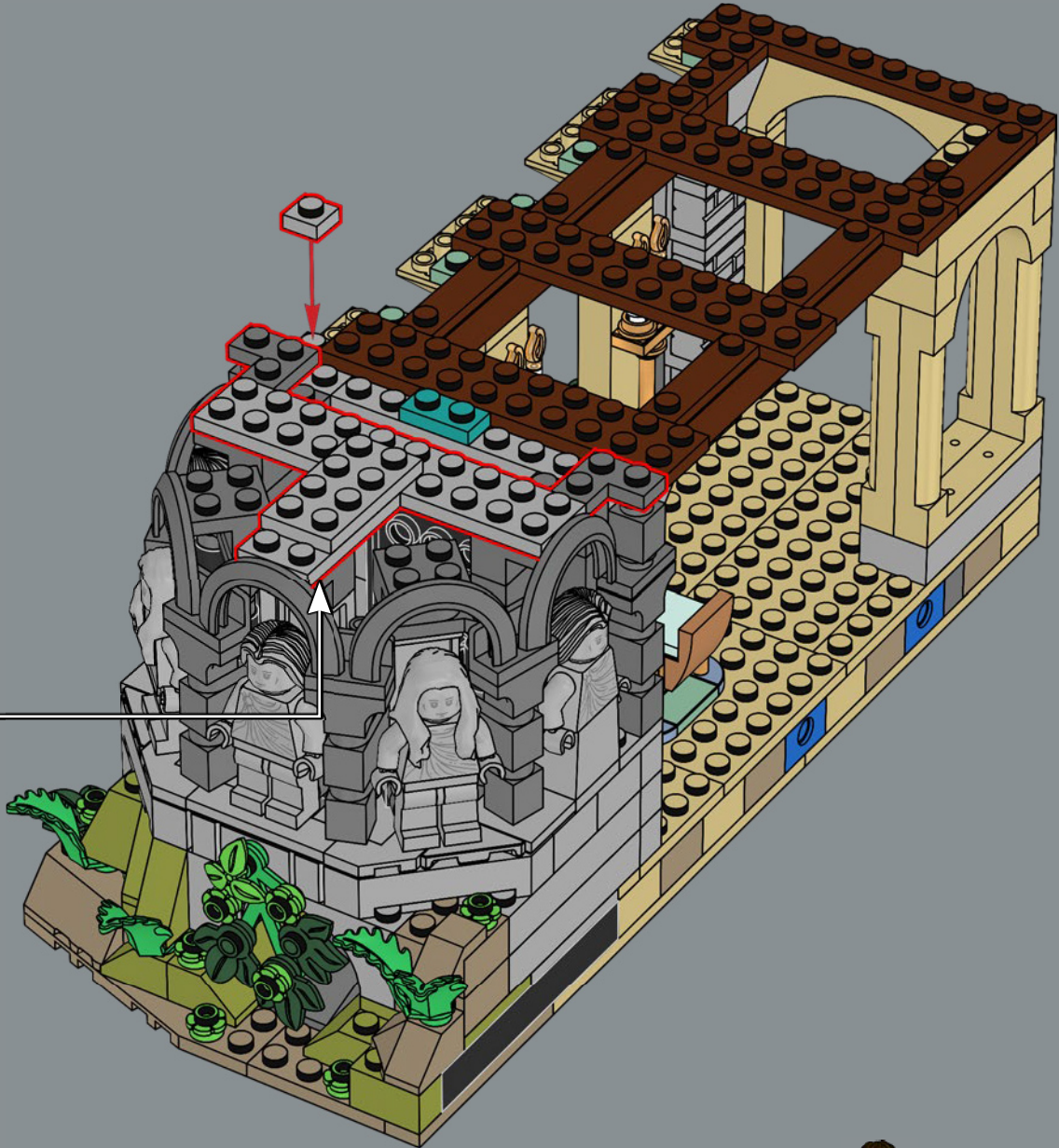
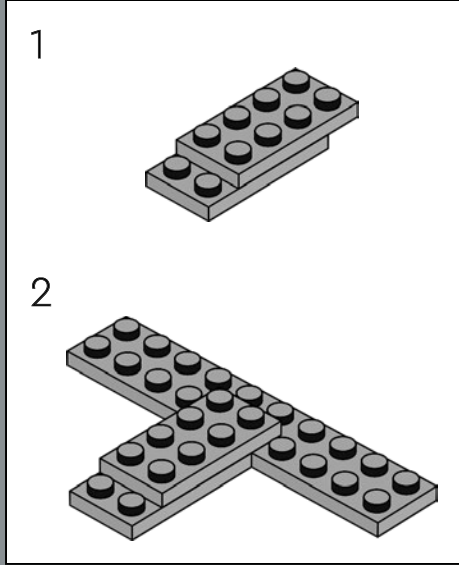

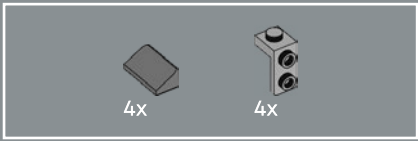

86

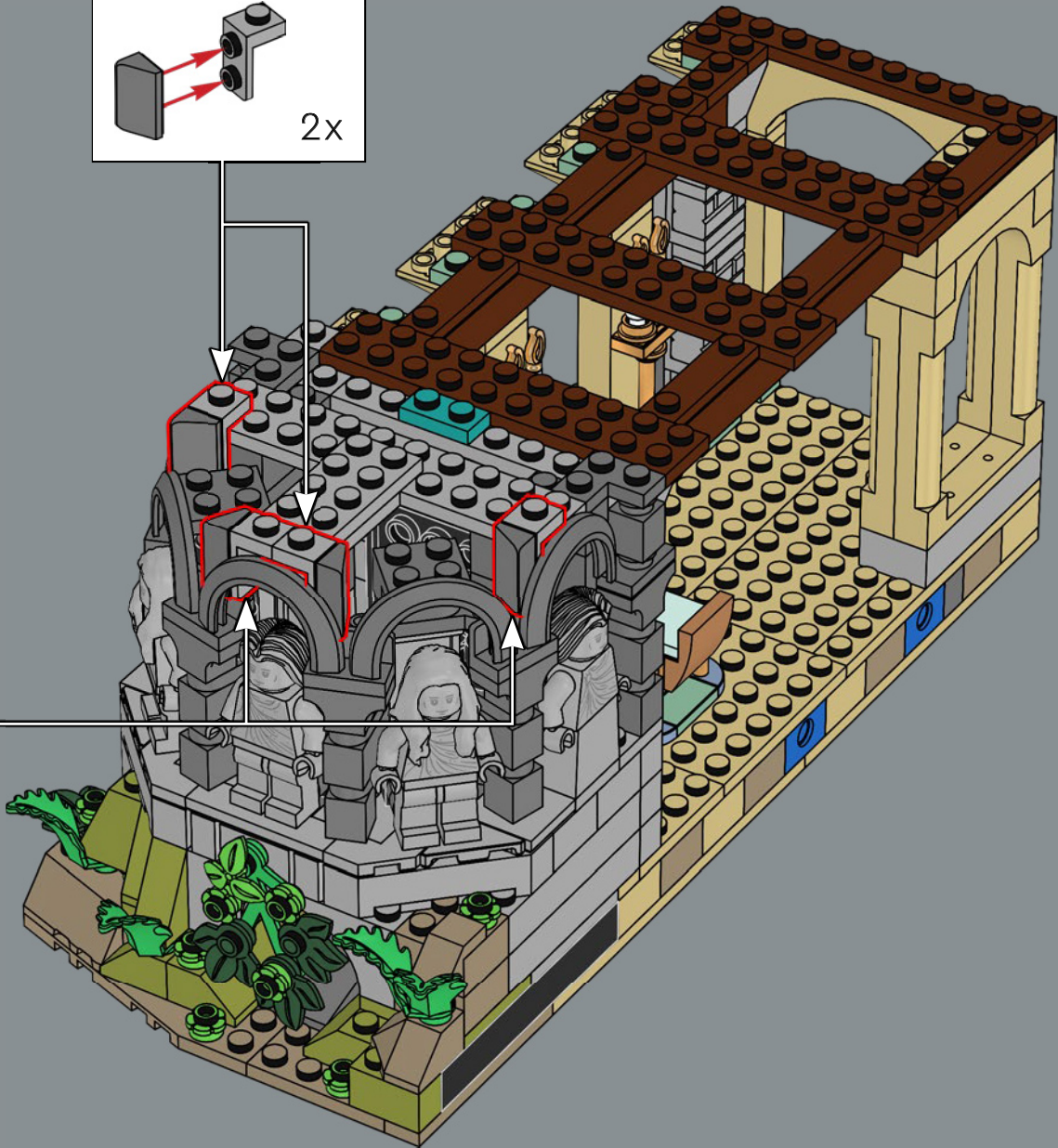
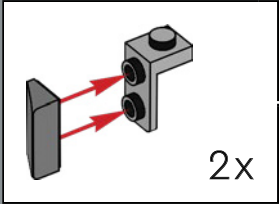
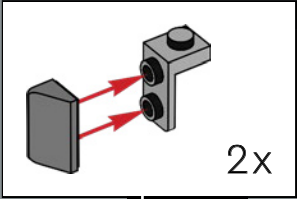

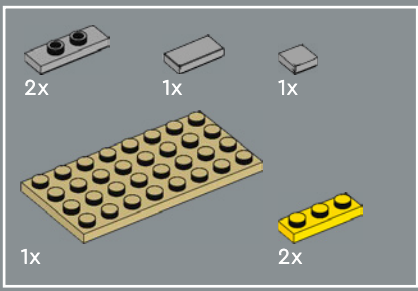

87



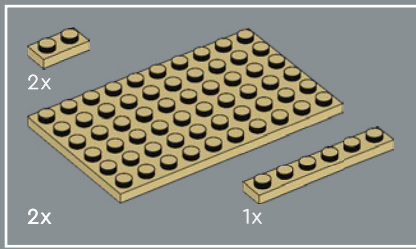

88



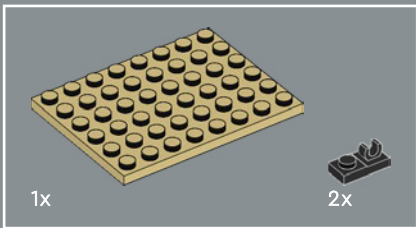
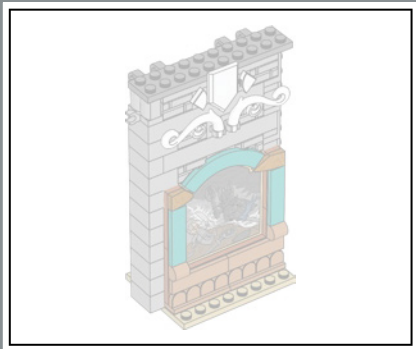

89

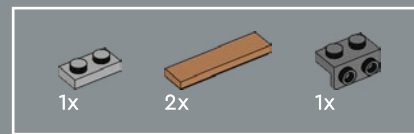
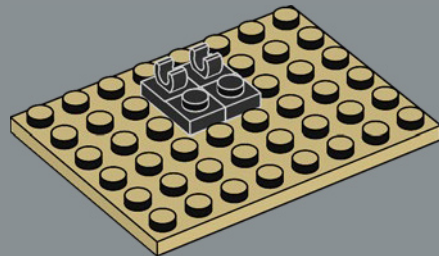

90

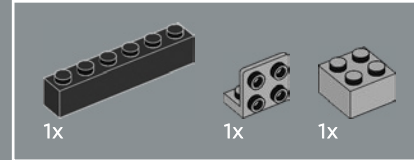
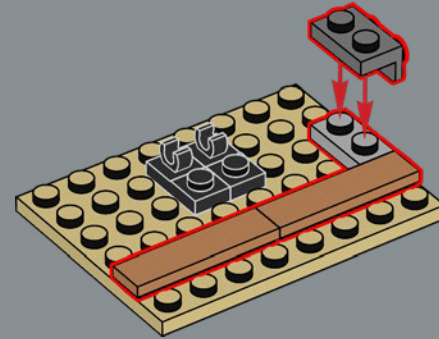

91

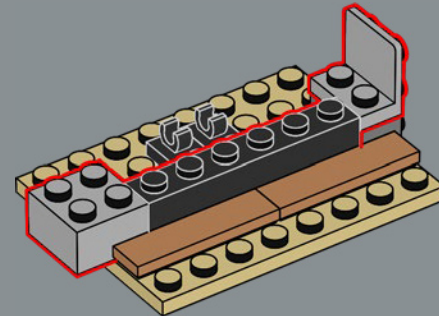

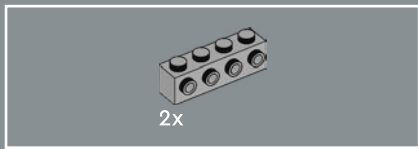

92

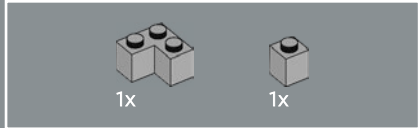
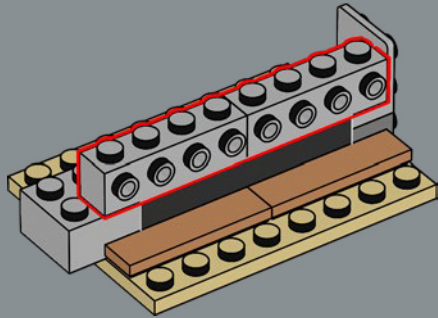

93

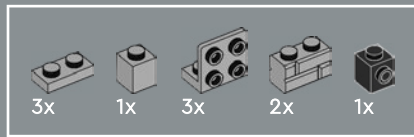
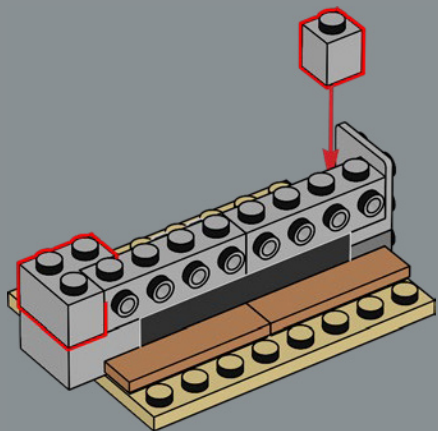

94

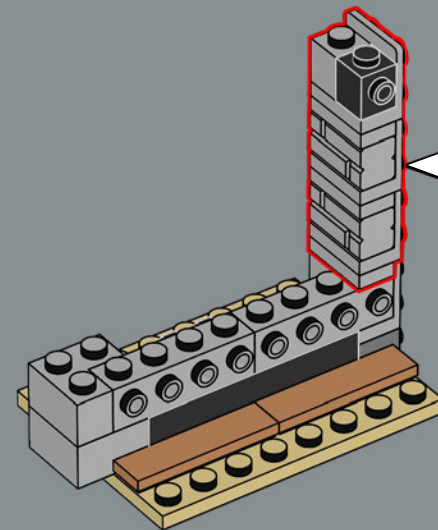
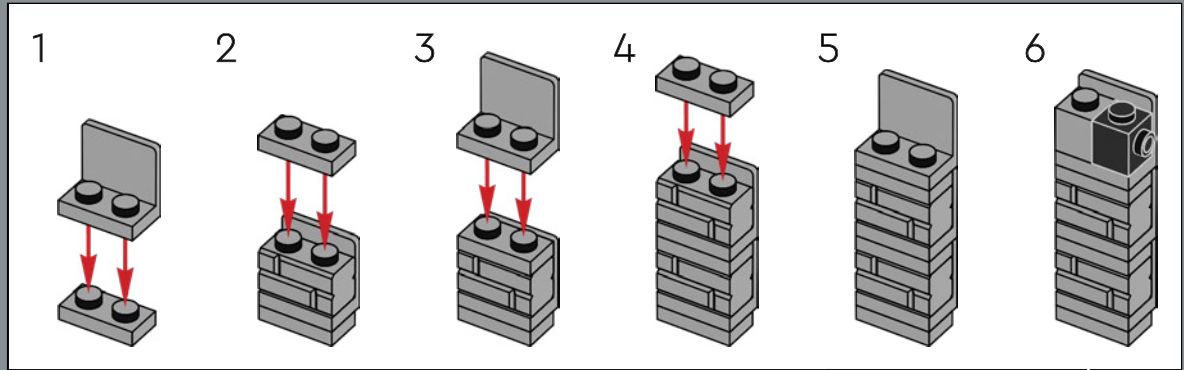

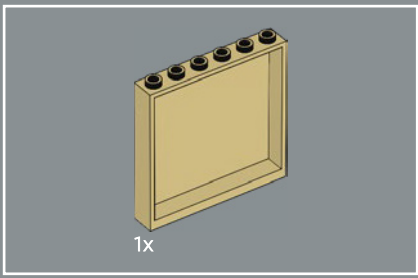

95

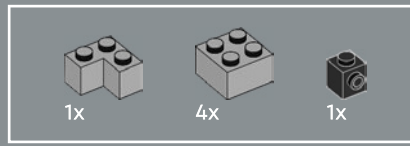
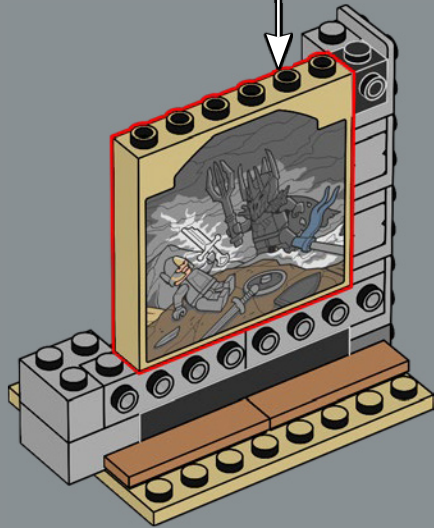
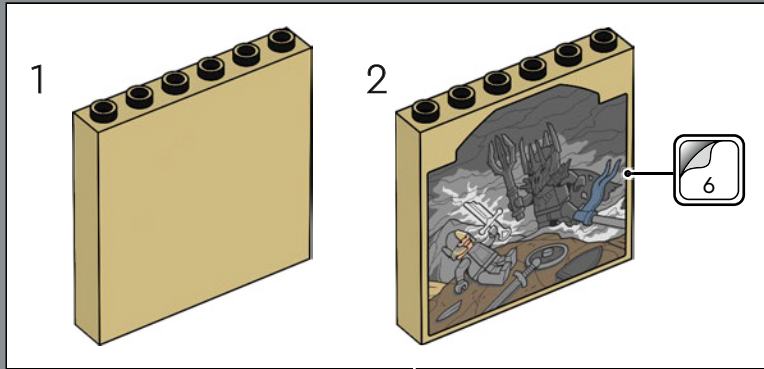

96

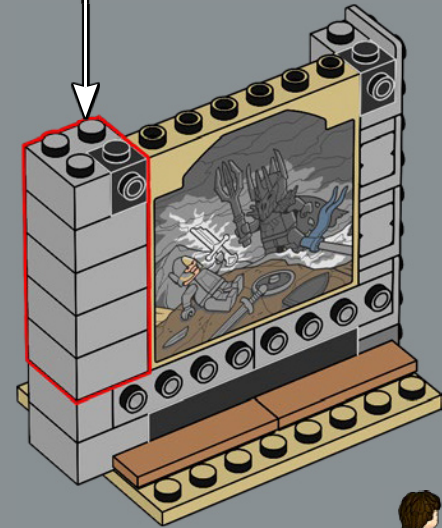
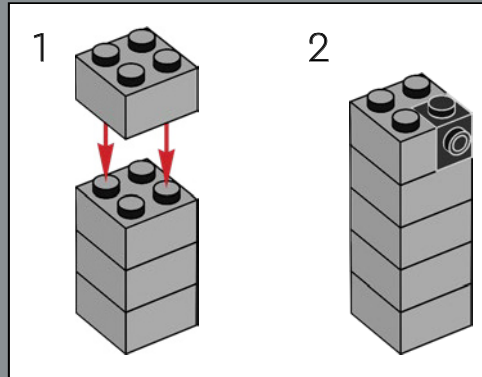

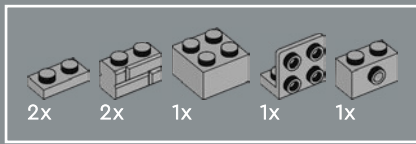

97

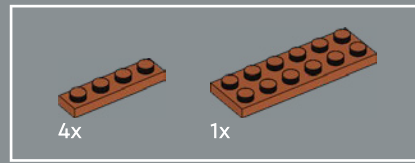
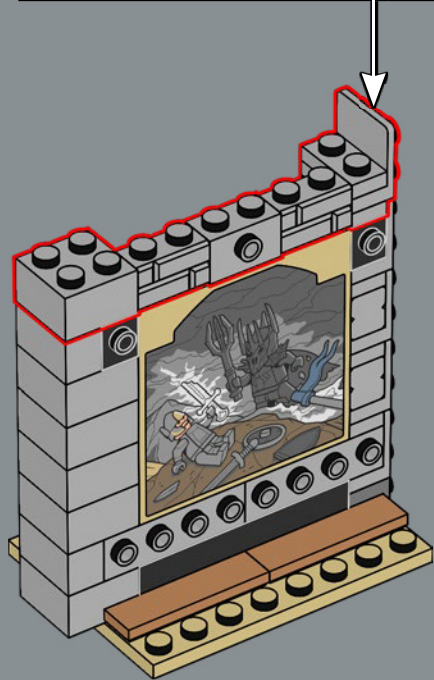
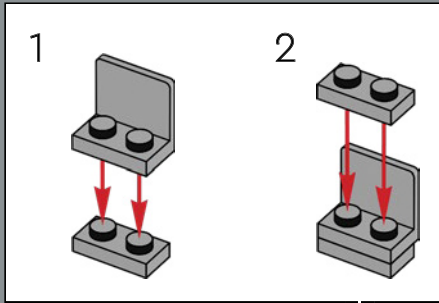

98

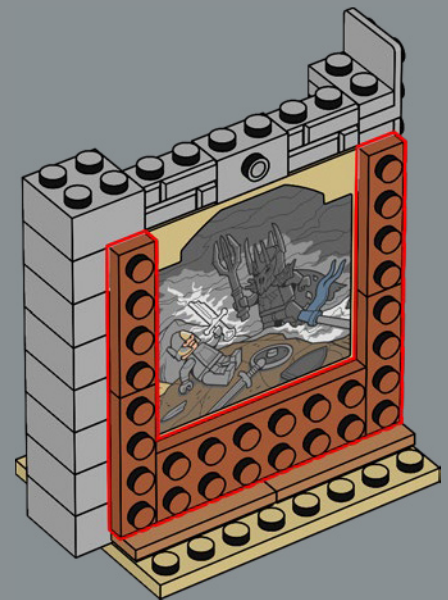

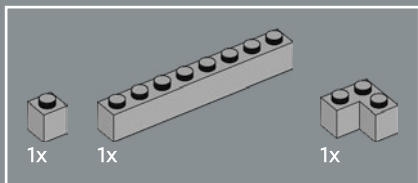

99

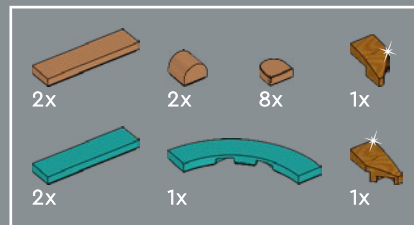
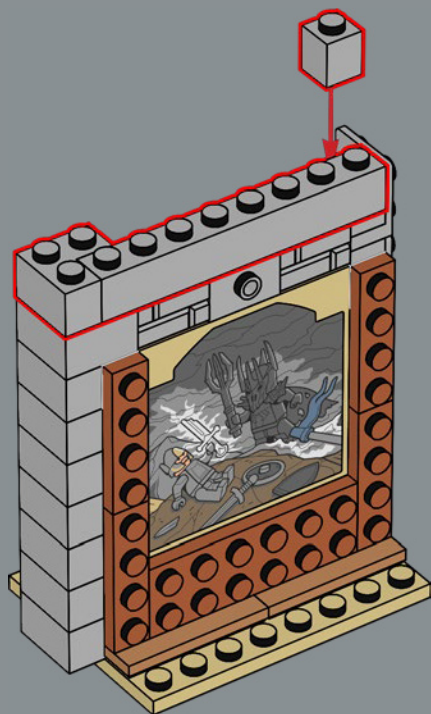

100

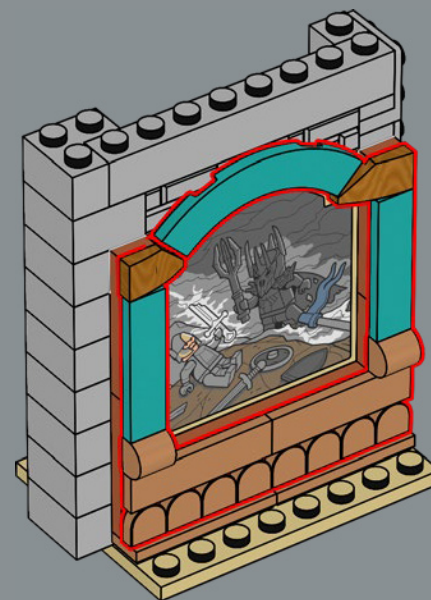

La destruction de Sauron traduite dans l'univers LEGO® comprend le tout nouveau pommeau de Narsil et un magnifique cadre bleu canard.



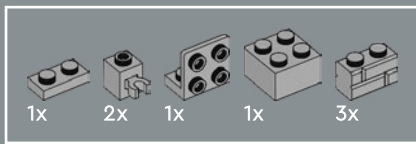

101

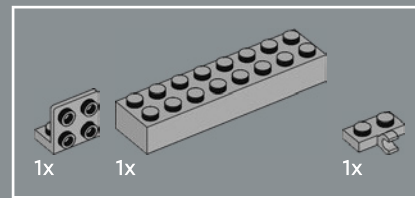
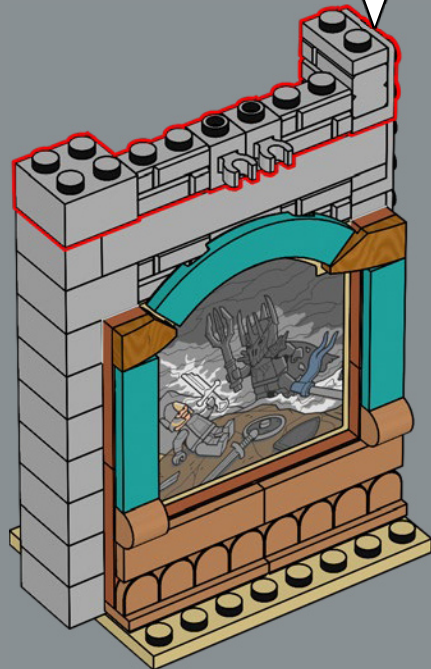
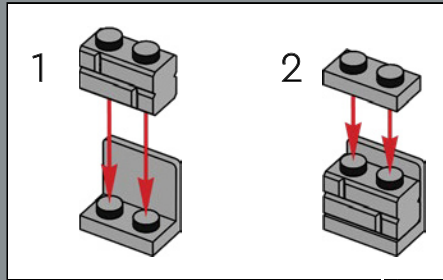

102

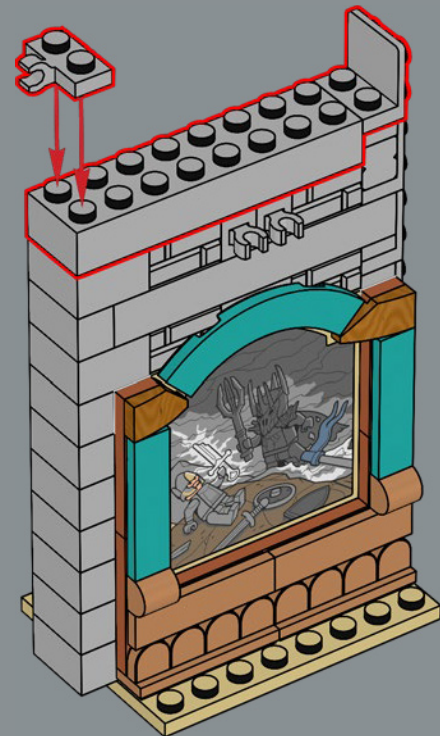

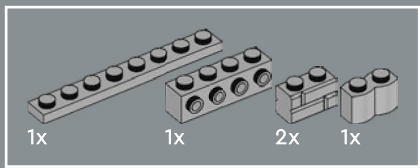

103

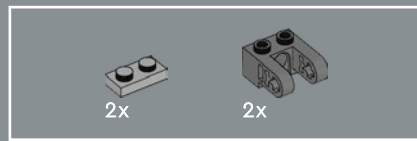
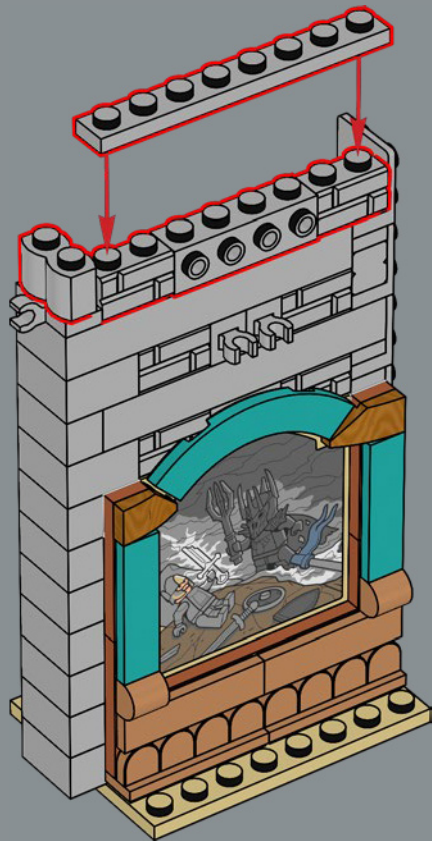

104

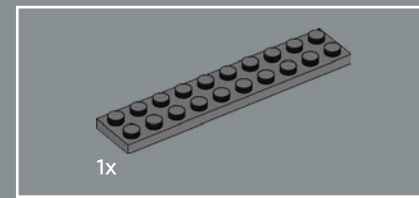
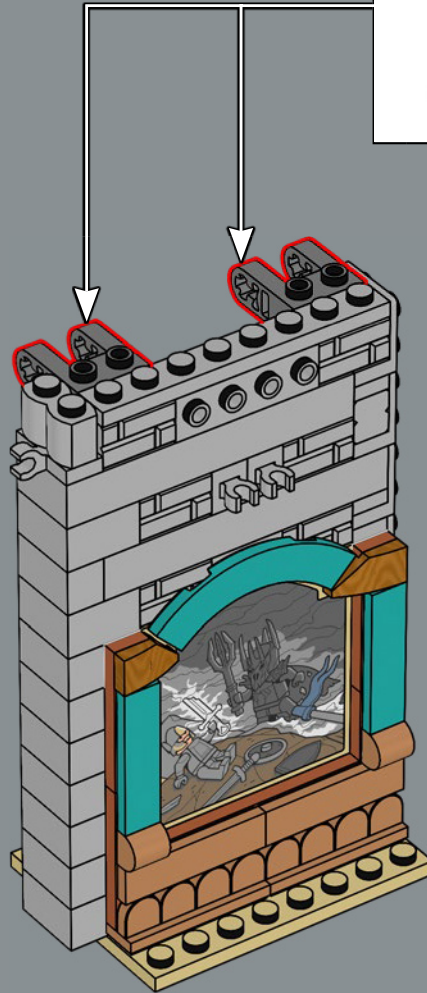
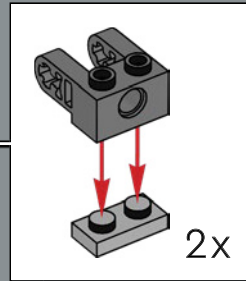

105

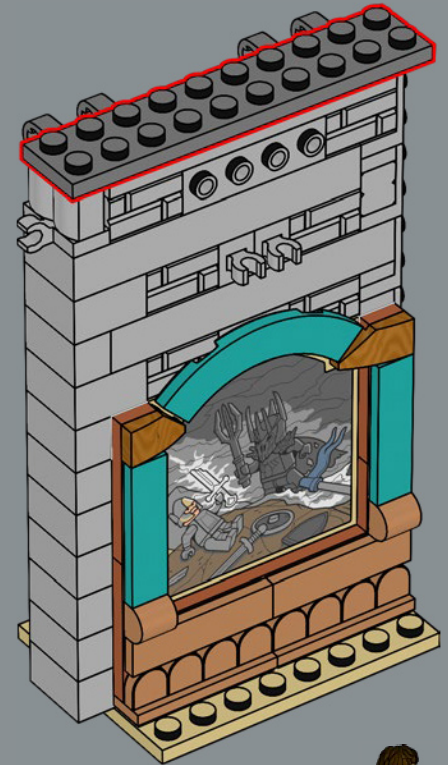



106



107

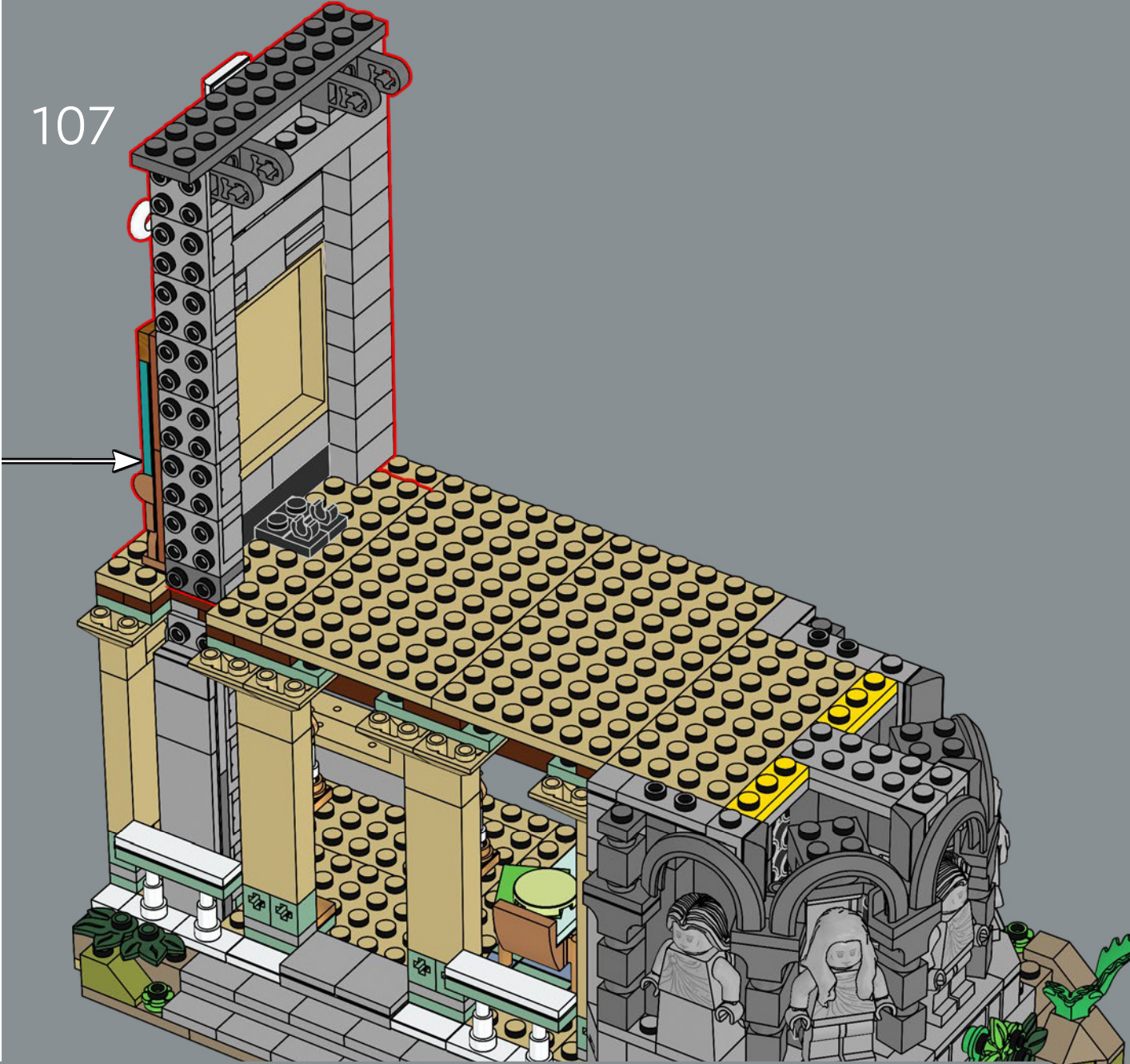

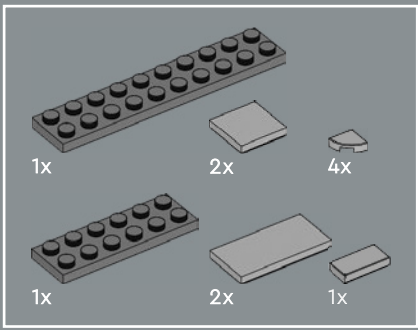

108

1

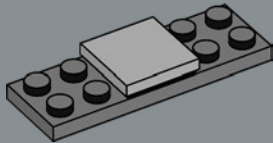

2

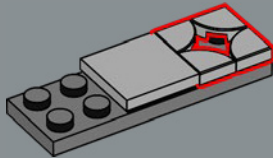

3

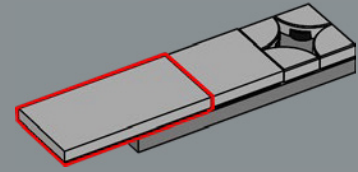

4

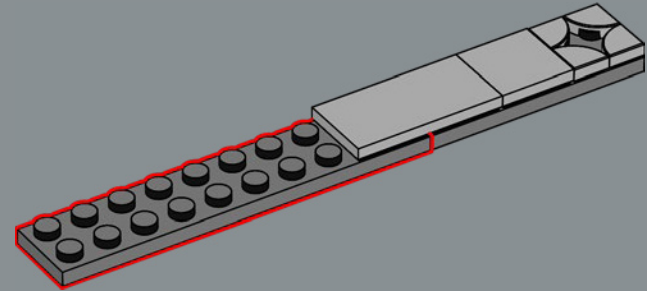

5

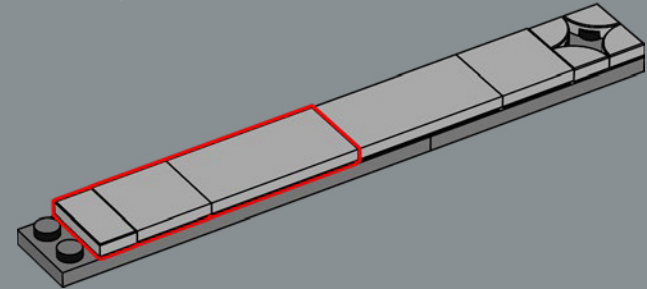

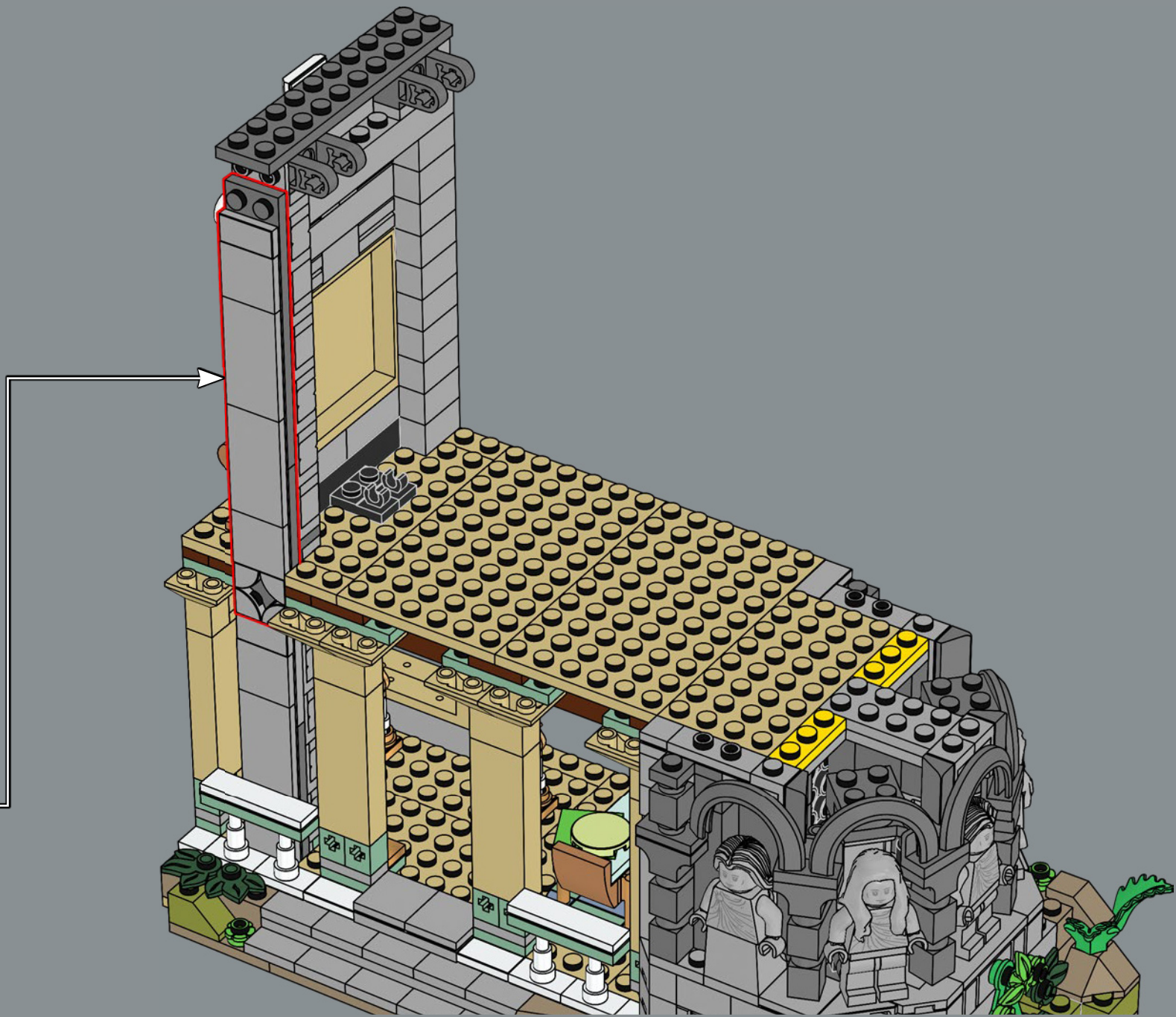

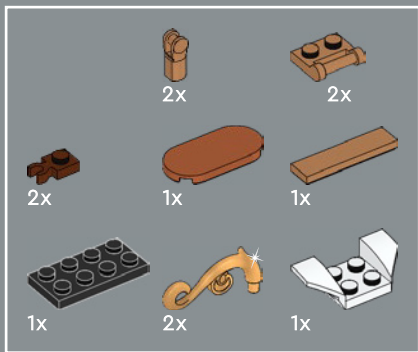

109

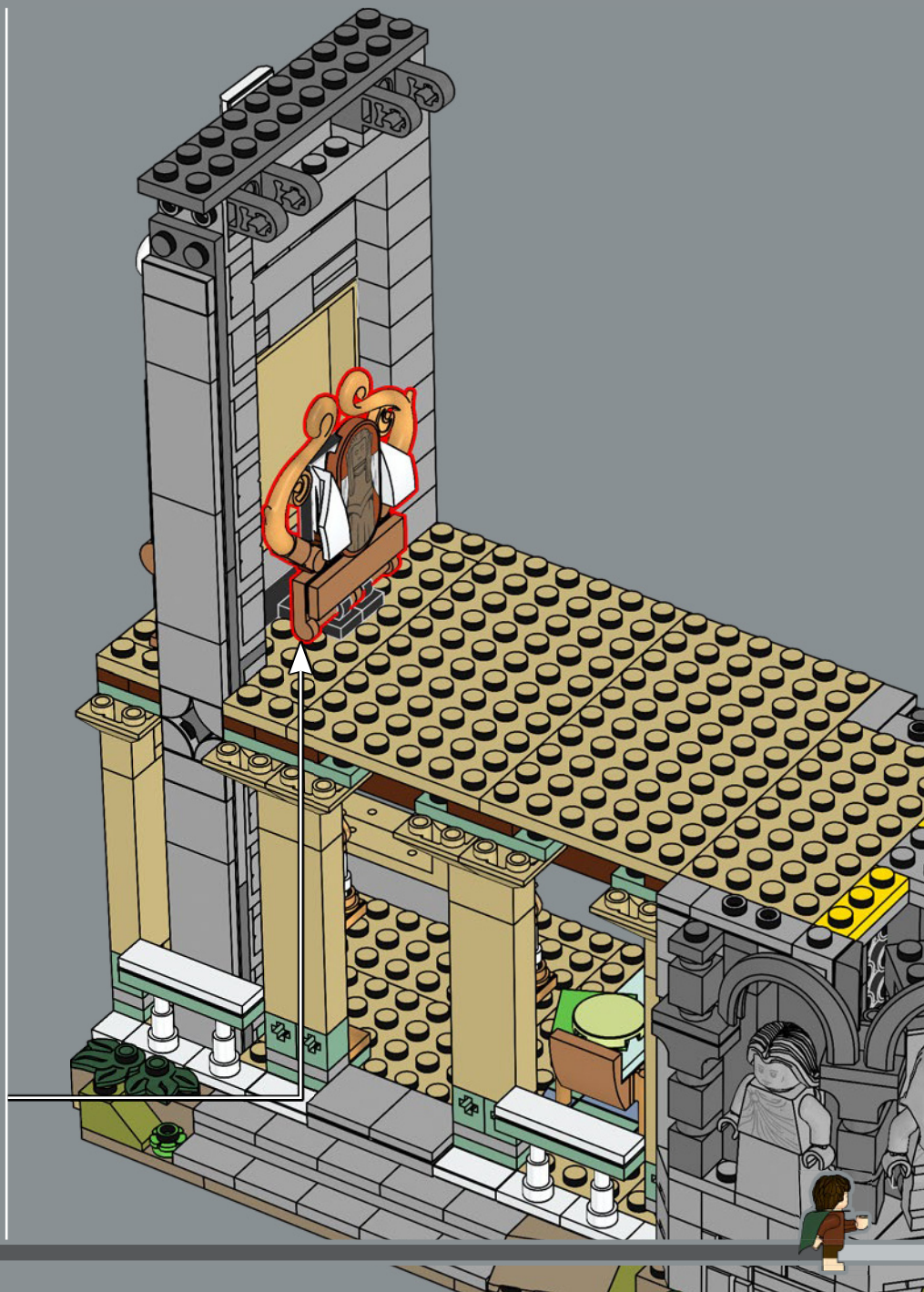
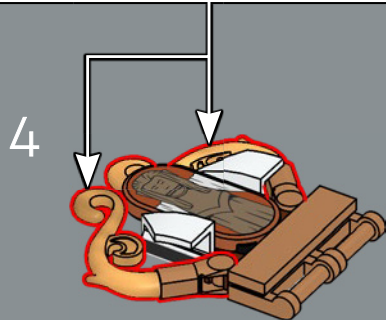
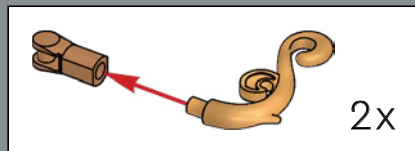
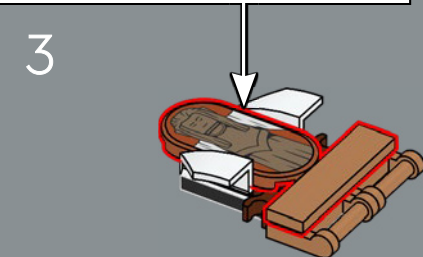
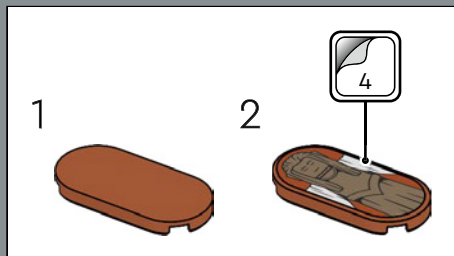
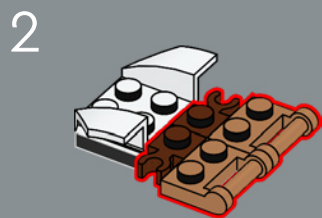
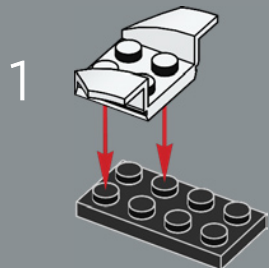

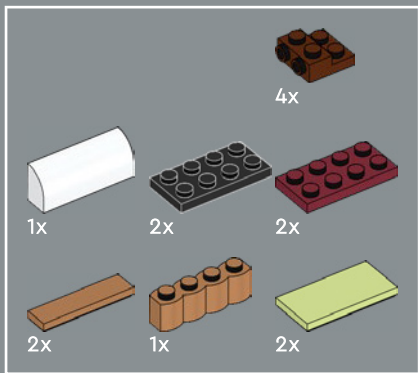

110

1

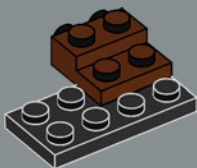

2

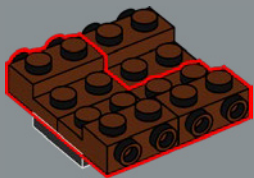

3

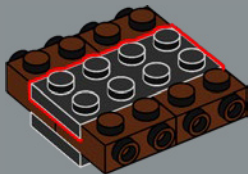

4



5



6

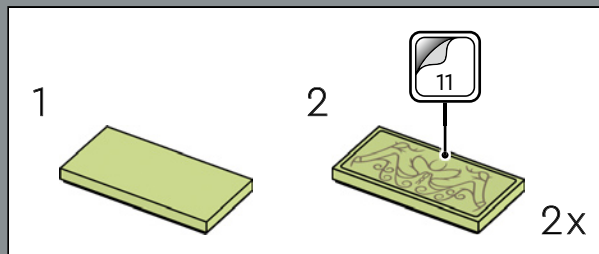
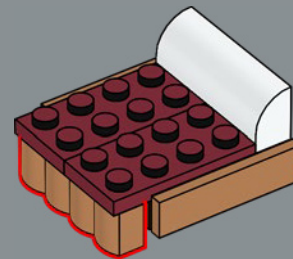

7

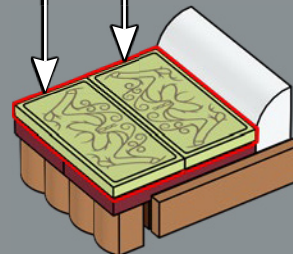

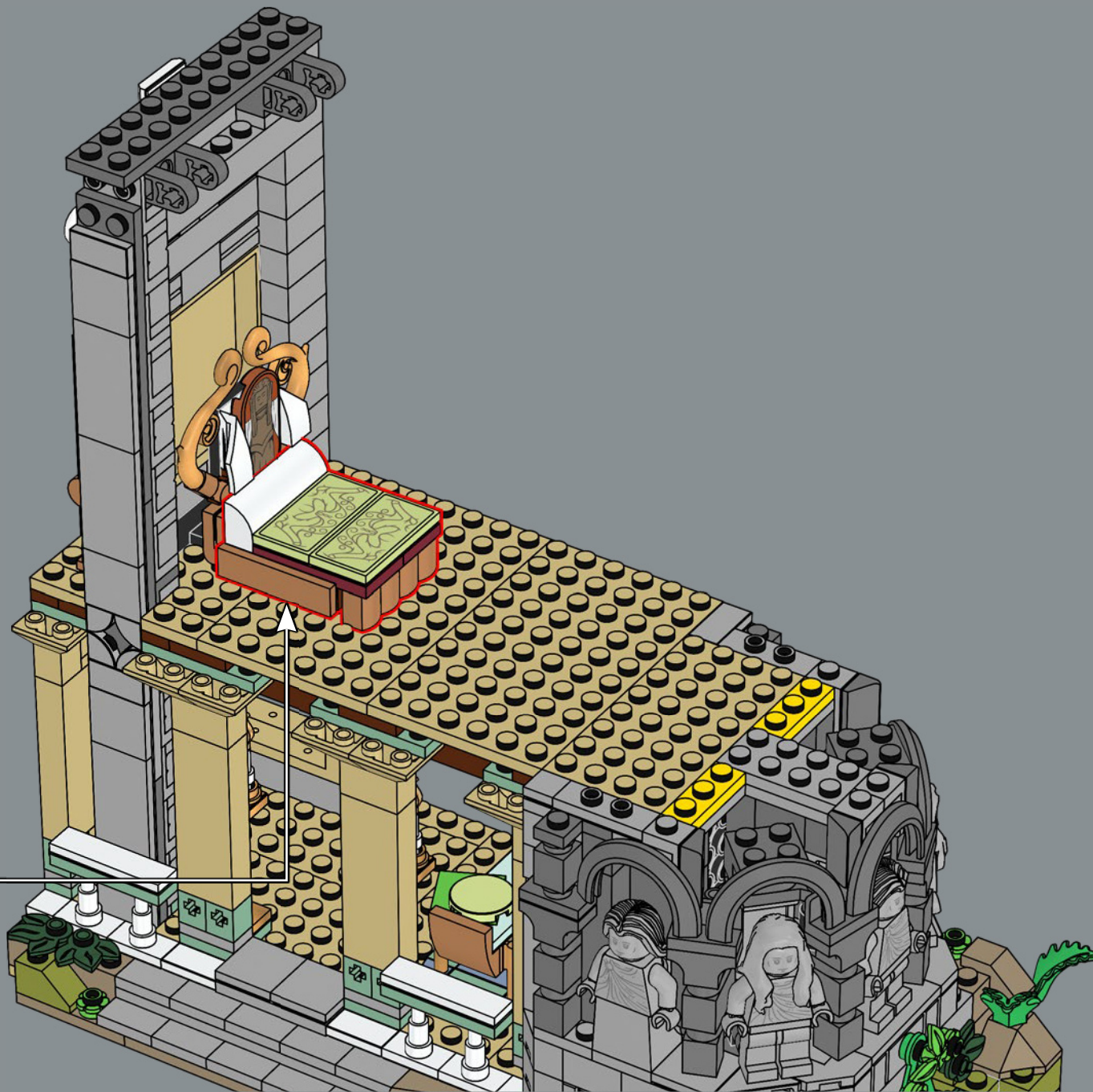



111

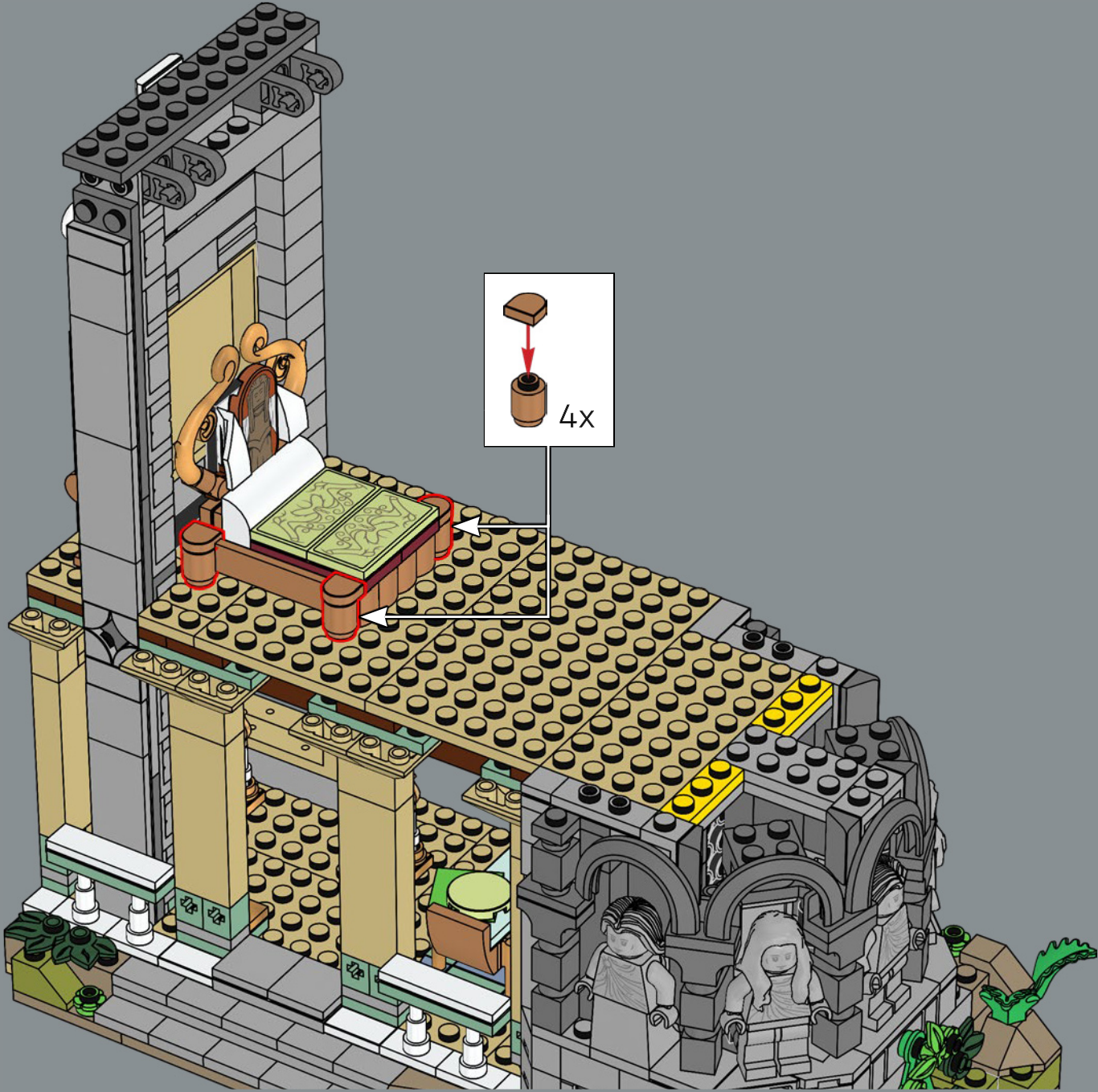

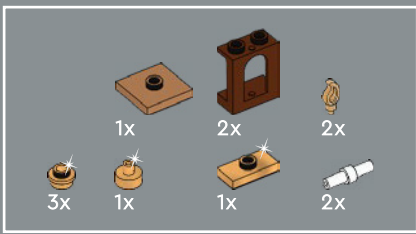

112

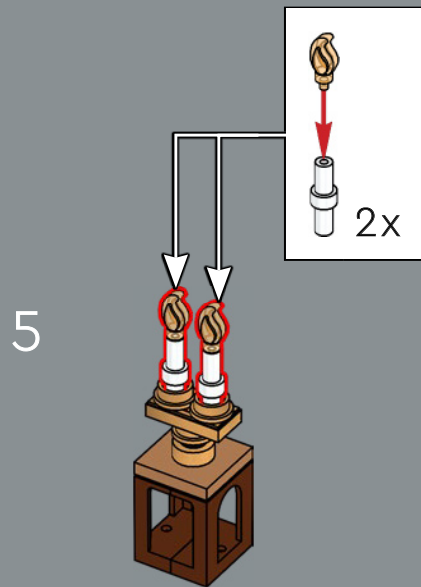
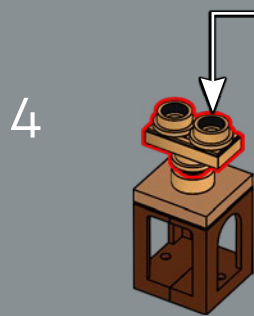
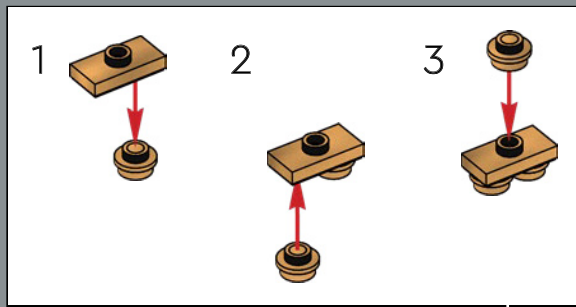
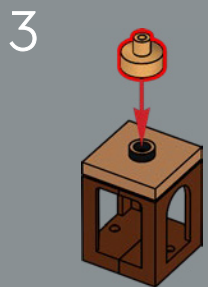
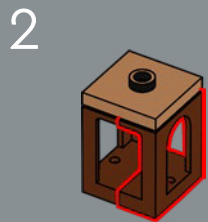
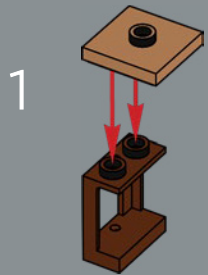

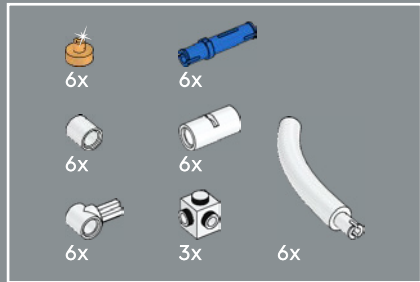
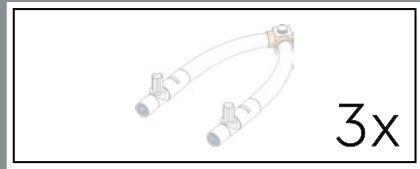

113

1



2



3

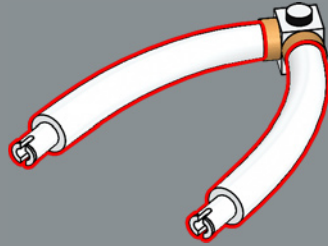

4

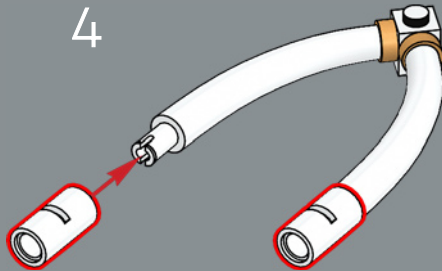

5

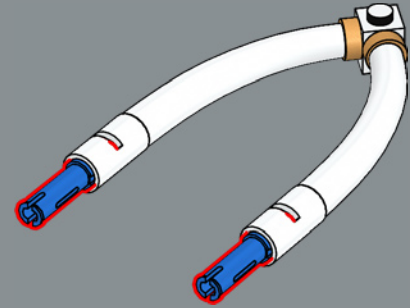

6

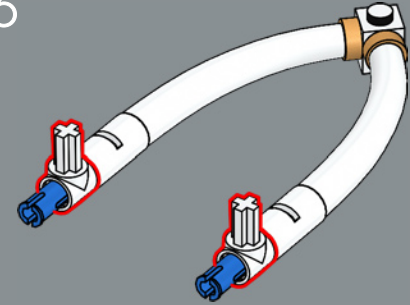

7

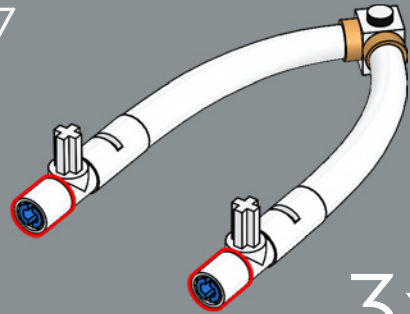

3x





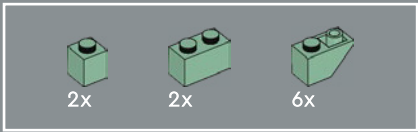

114



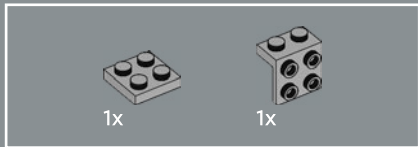
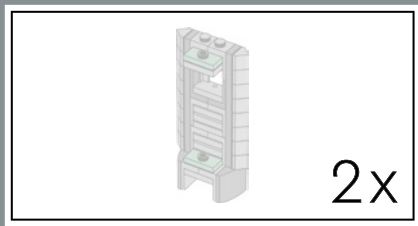

115

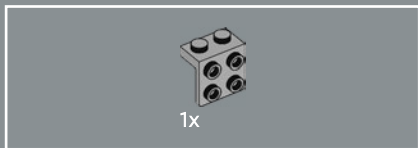
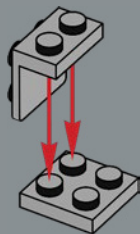

116

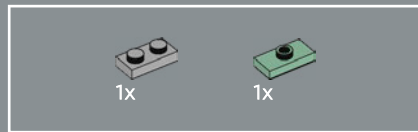
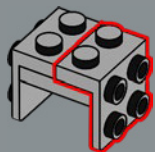

117

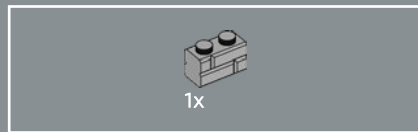
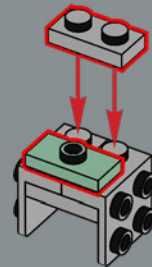

118

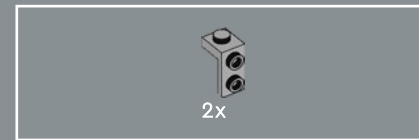
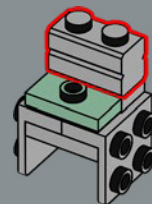

119

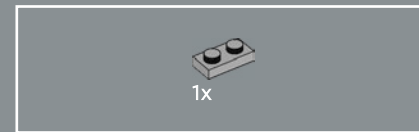
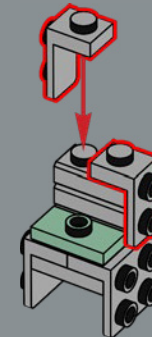

120

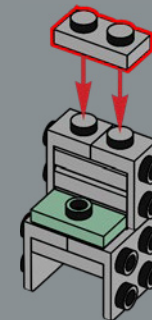

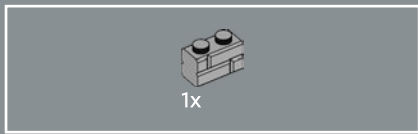

121

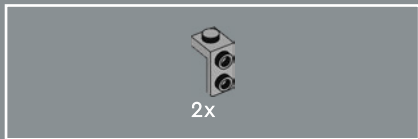
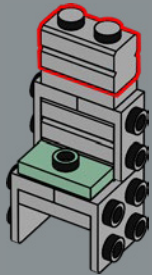

122

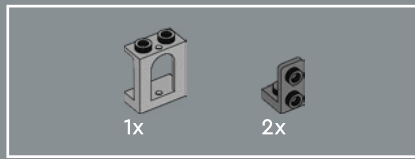
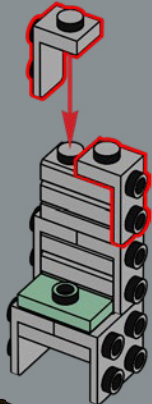

123

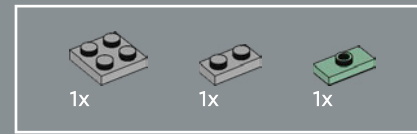
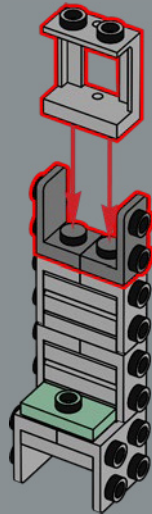

124

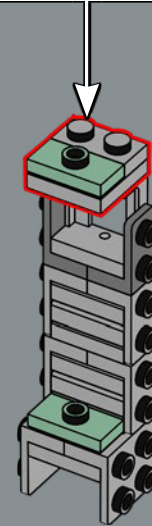
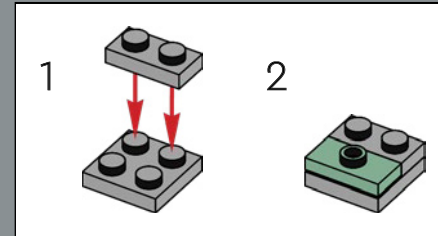



2x

125

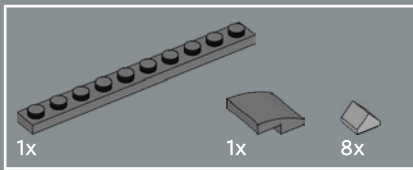
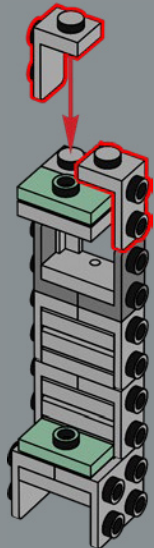

126

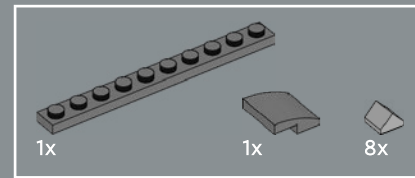
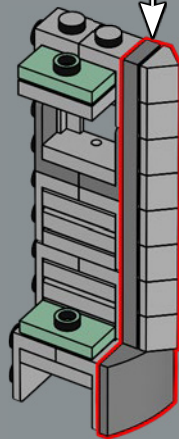
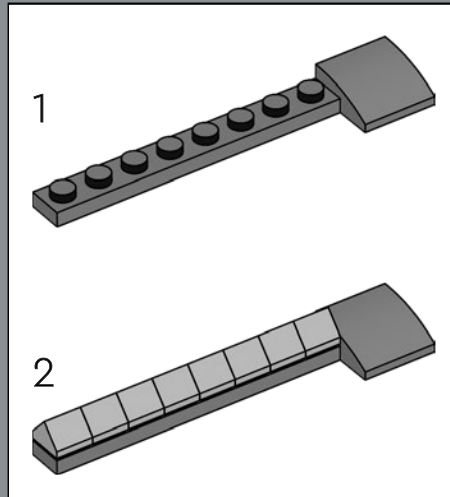

127

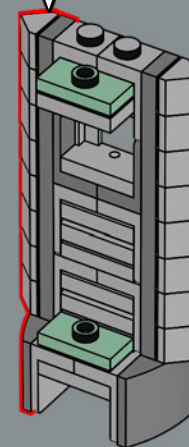
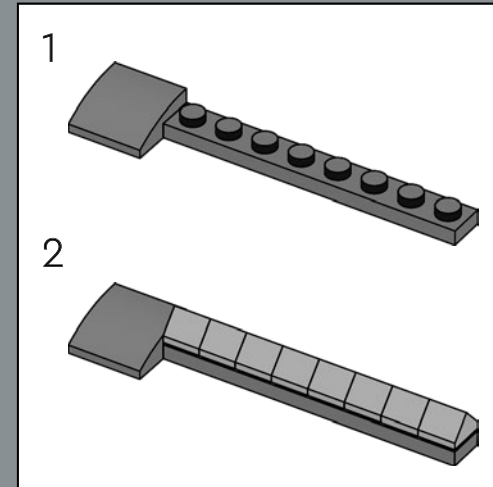

2x

128



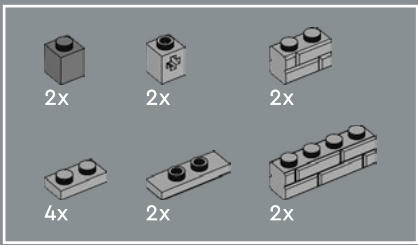

129

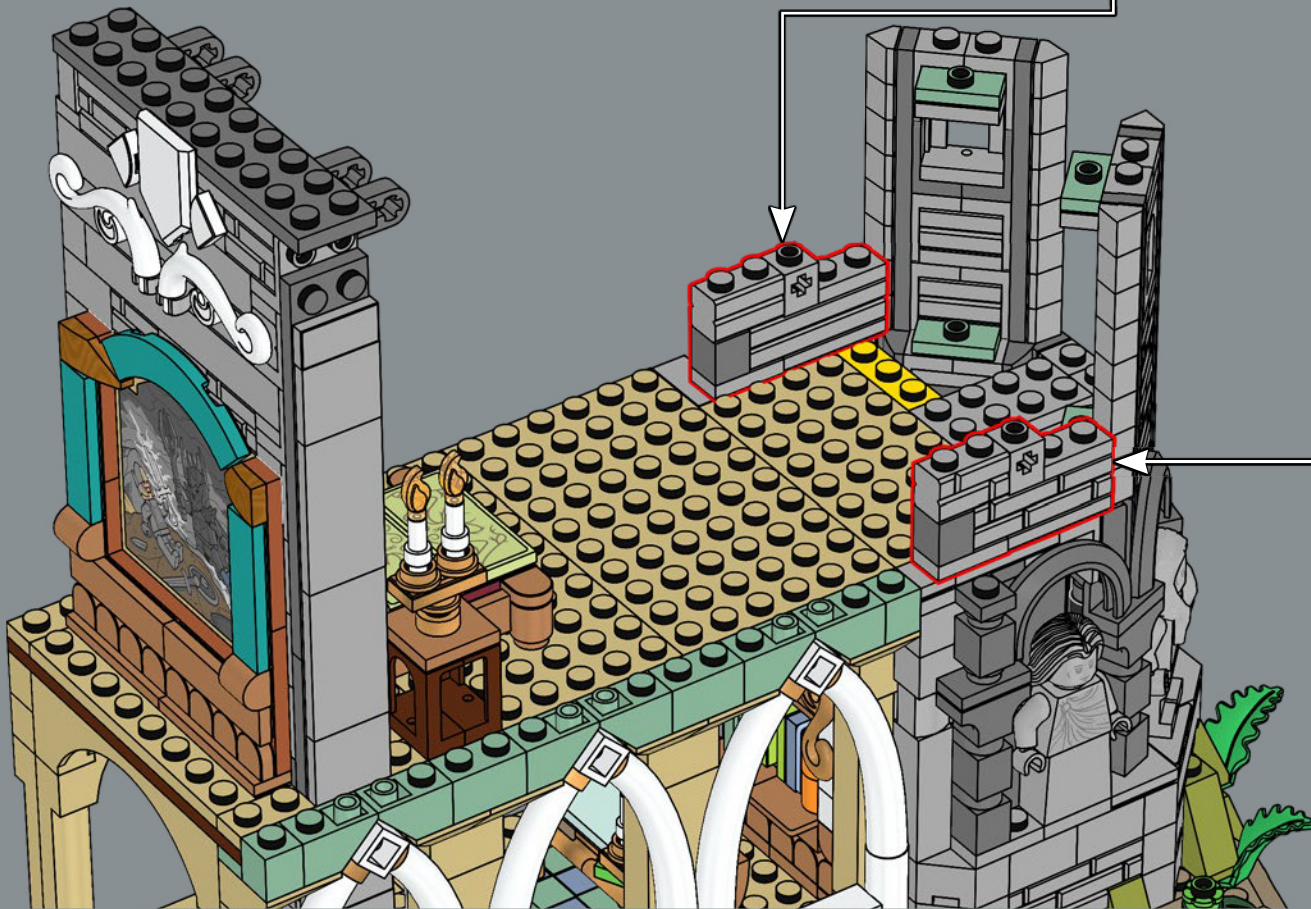
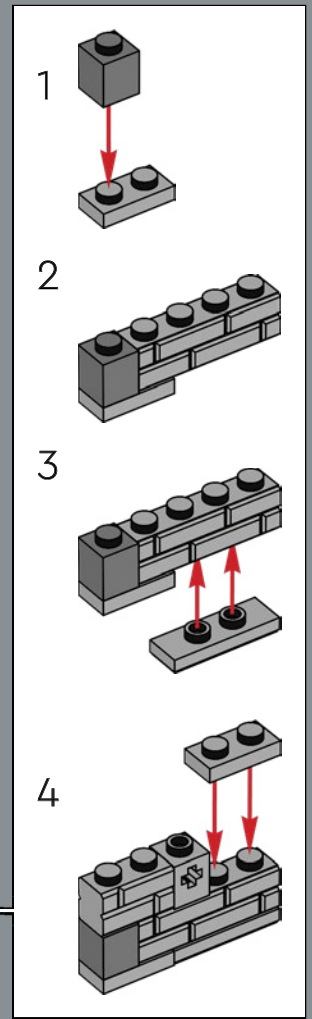
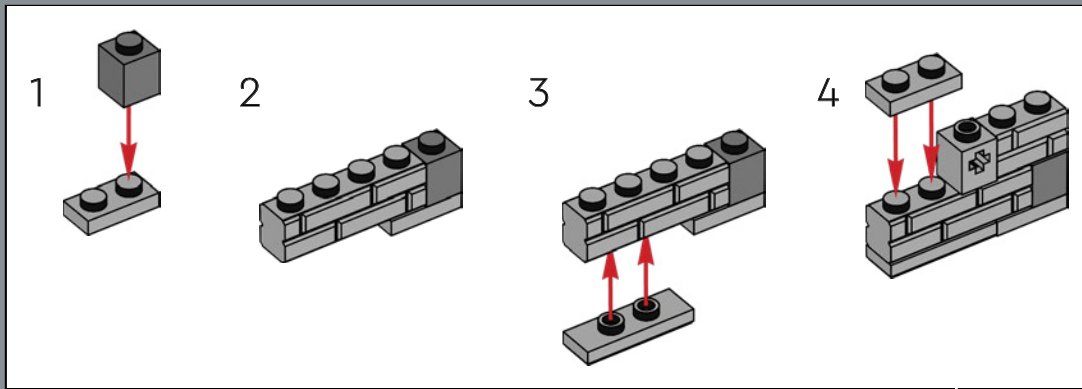

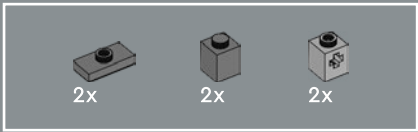

130

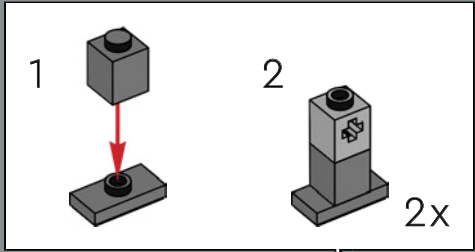

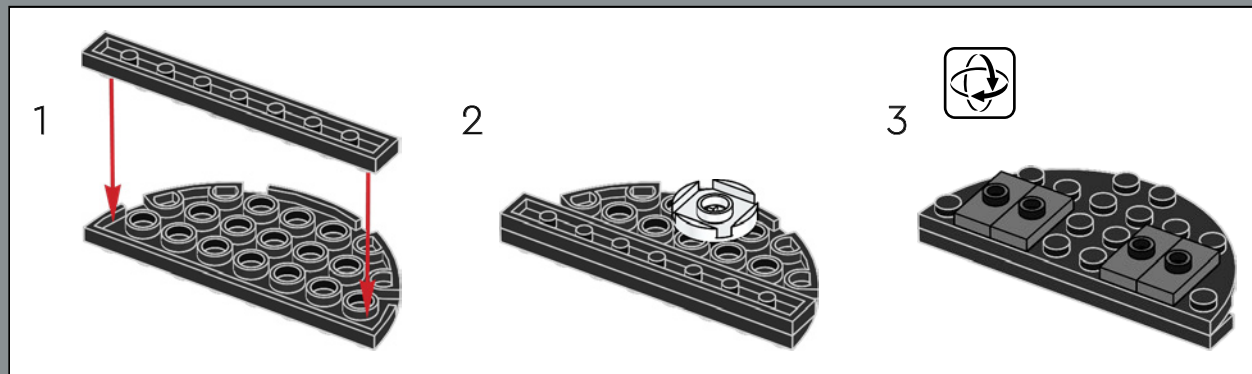
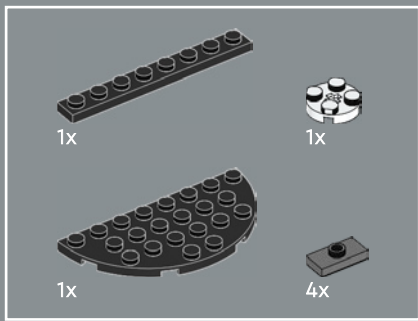

131

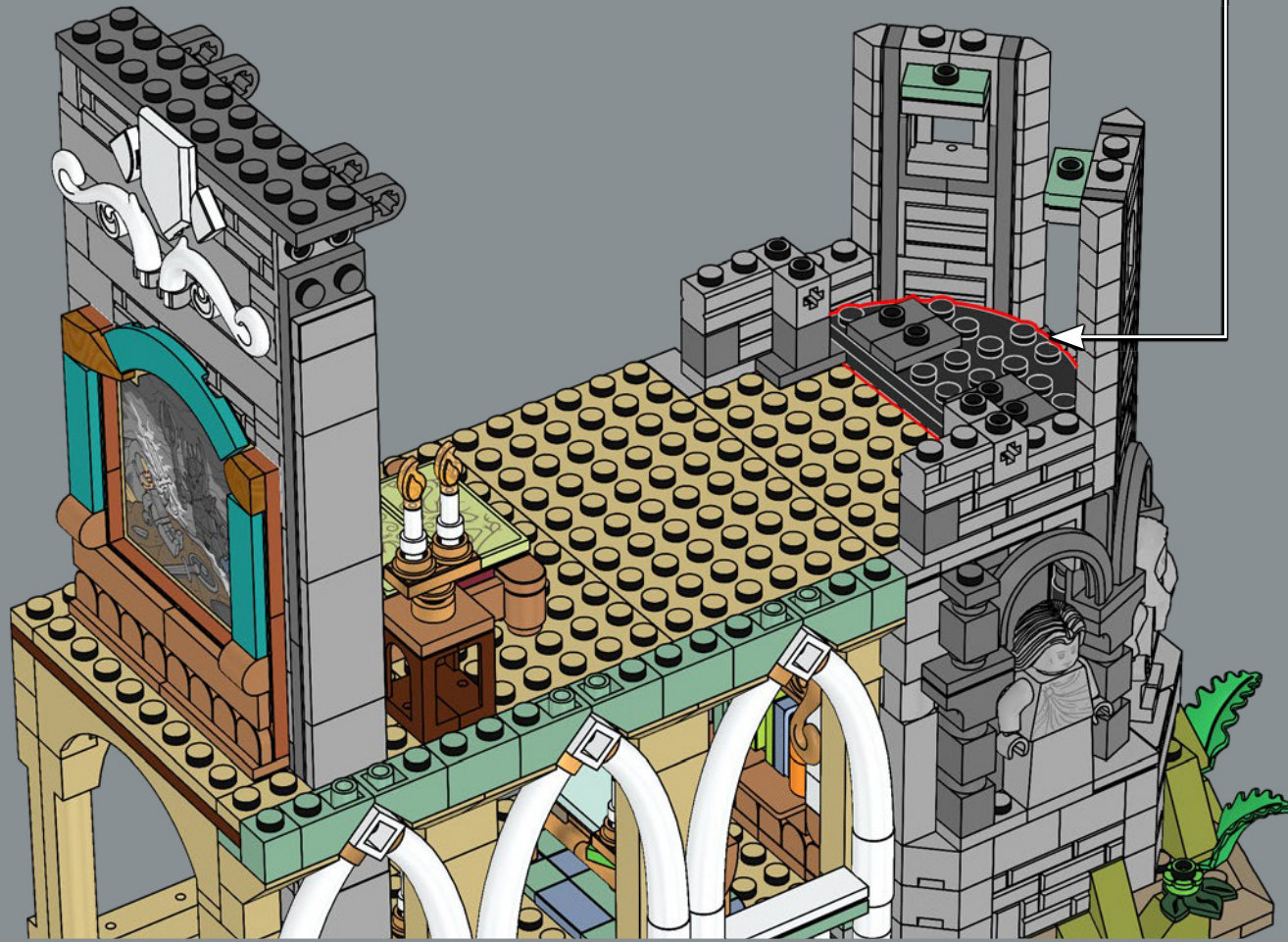

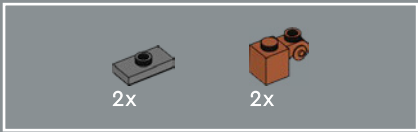

132

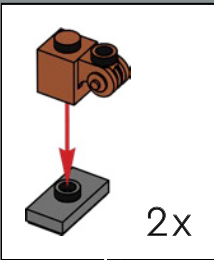

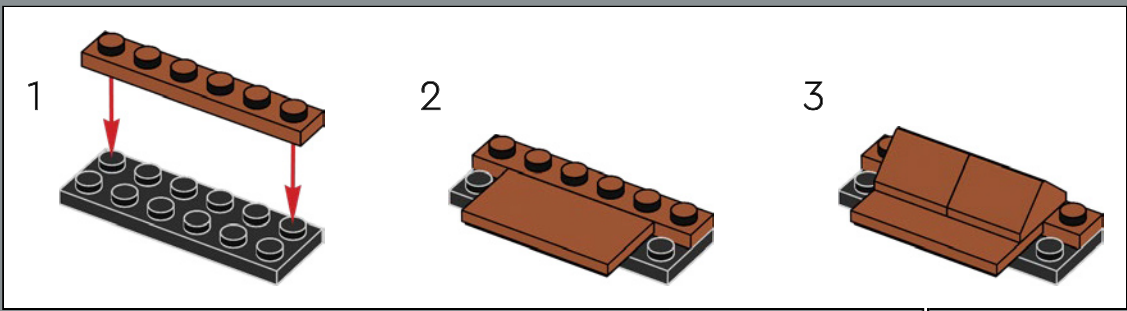
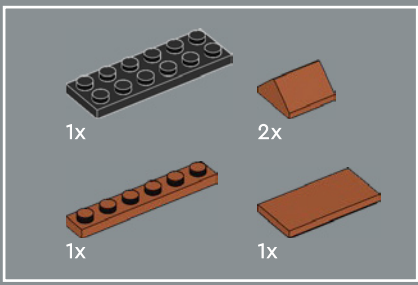

133



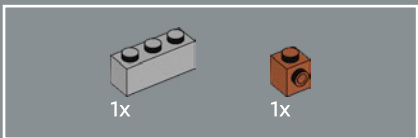

134

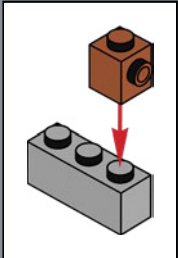



Non seulement ce bureau est l'endroit idéal pour écrire un livre, mais il offre également la stabilité nécessaire au toit et à la tour qui y seront fixés ultérieurement.

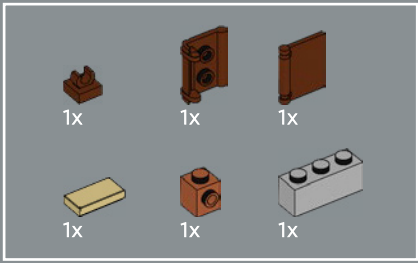

135

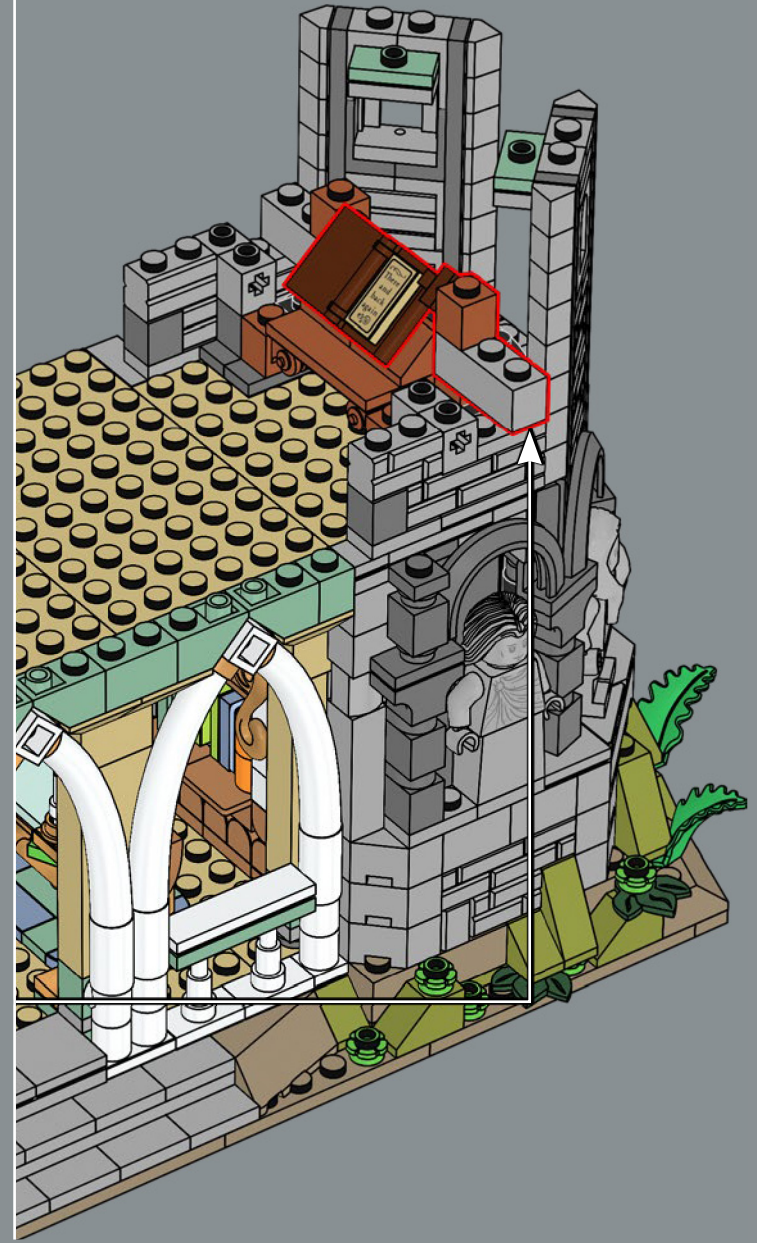
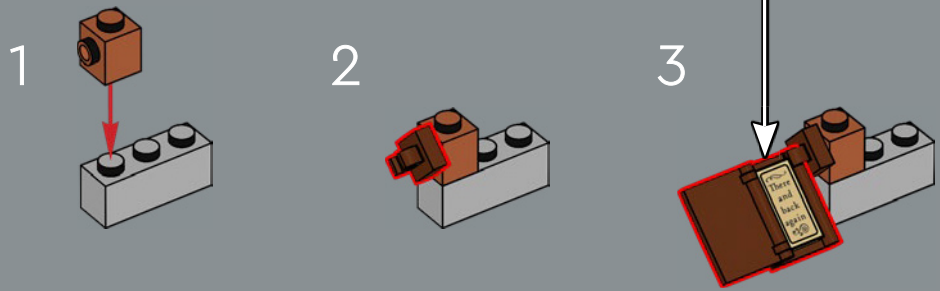
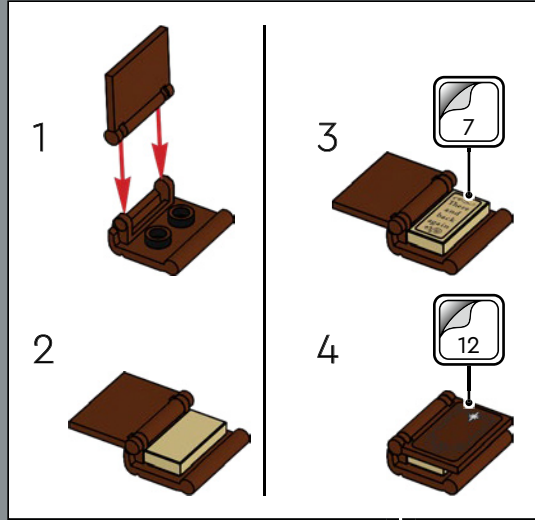

-  2x
-  1x
-  2x
-  1x
-  2x
-  2x
-  1x

136

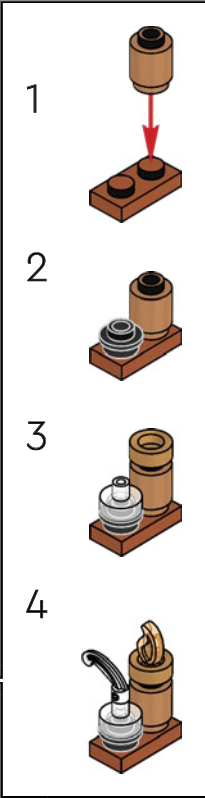
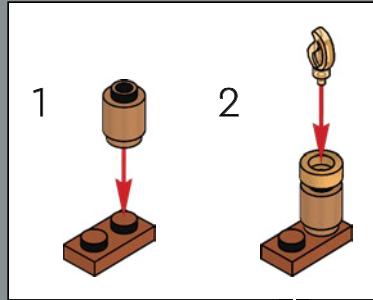

- 2x
- 4x
- 2x
- 2x

137

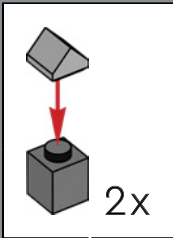



C'est la première fois qu'un modèle LEGO® présente le personnage de 111 ans : Bilbon. Ne laissez surtout pas l'Anneau à sa portée, car on ne sait jamais ce qu'il est capable de faire !

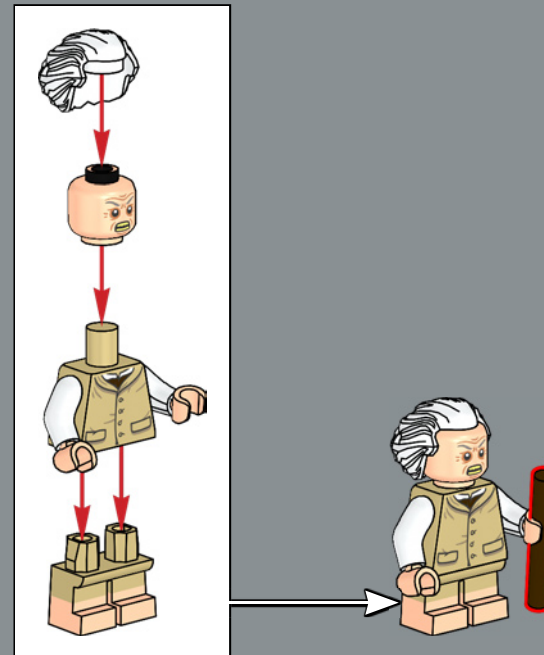

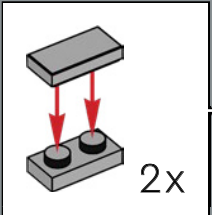
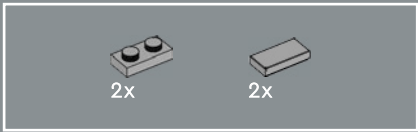

138

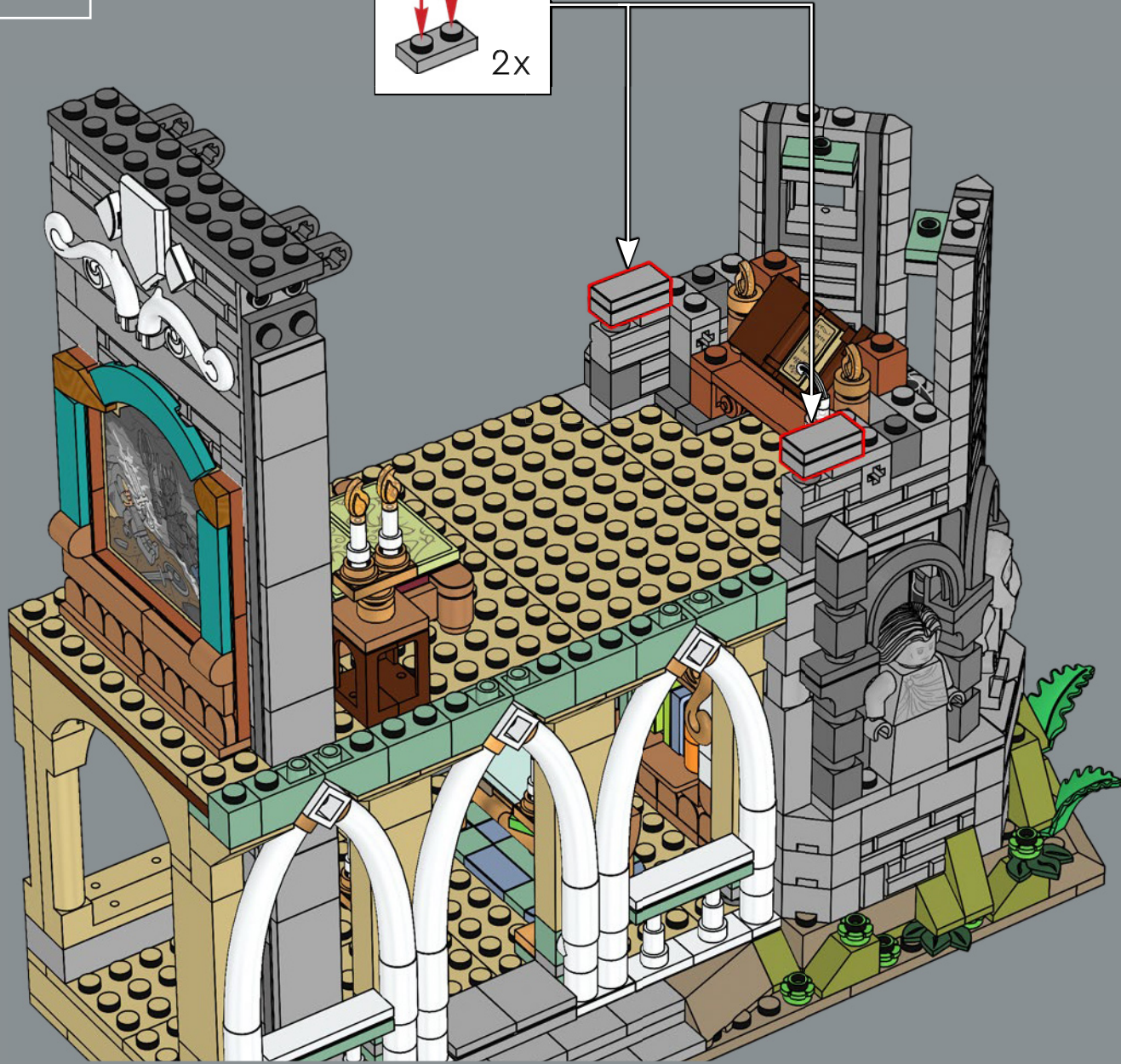

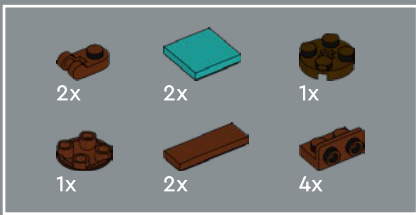

139

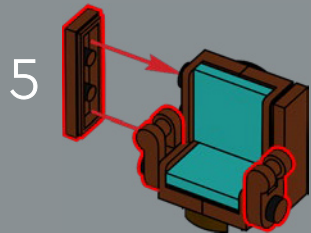
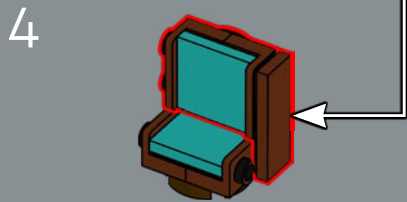
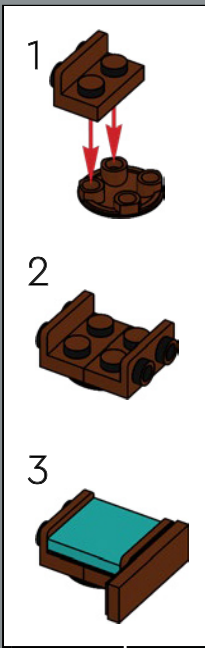
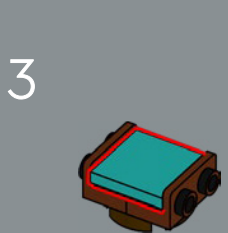
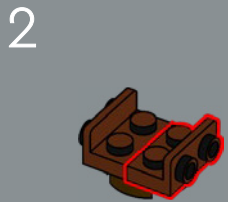
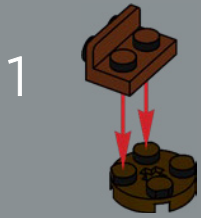

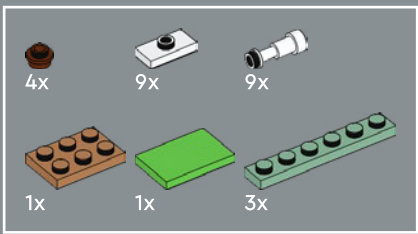

140

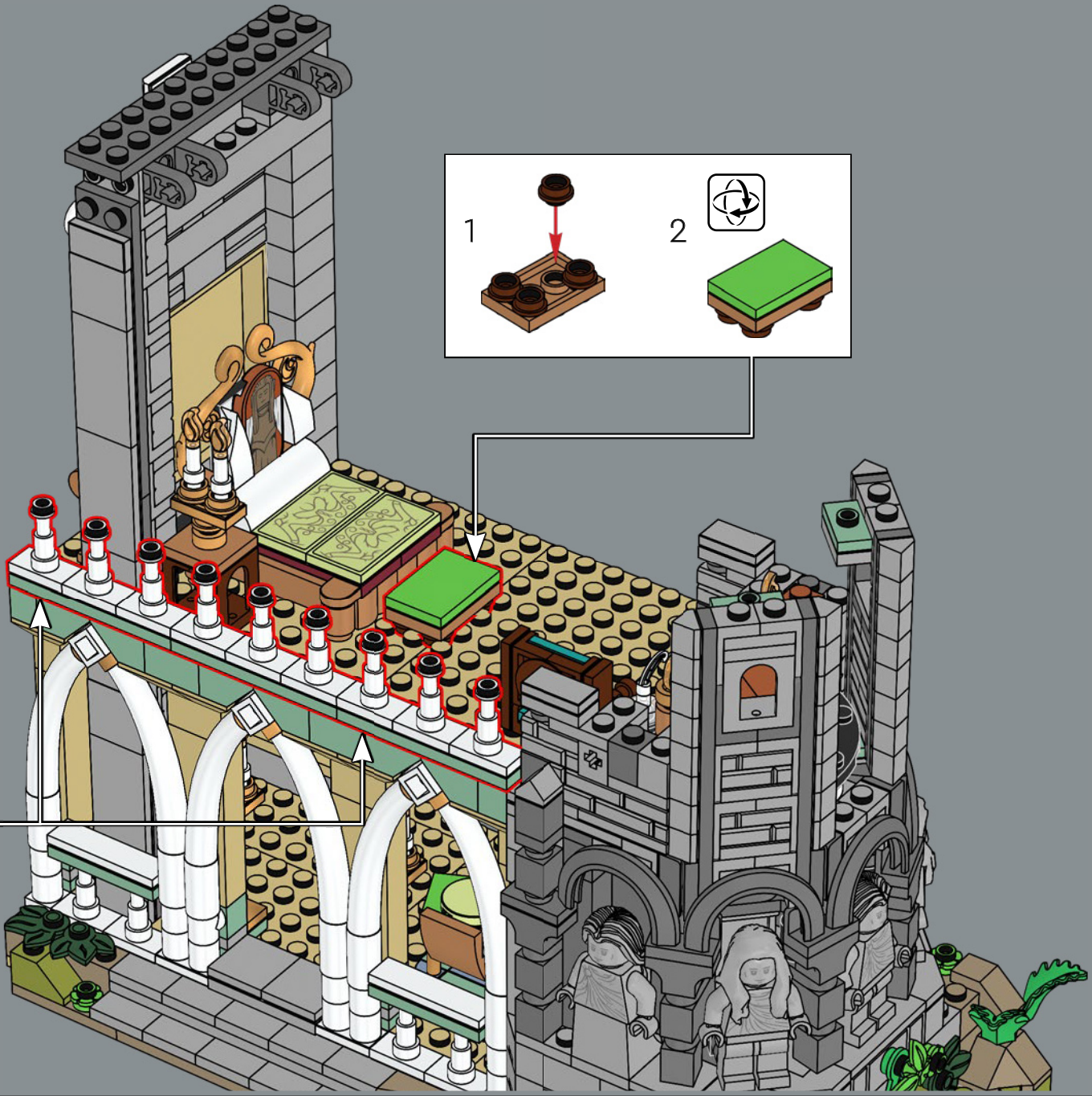
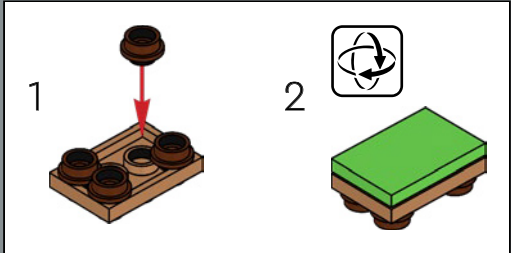
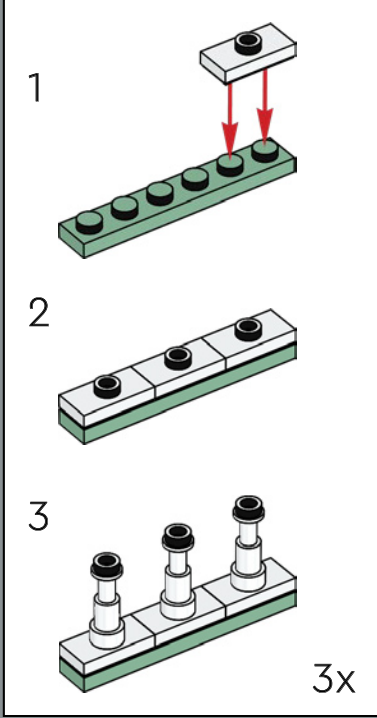

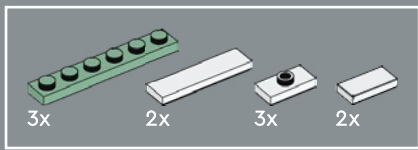

141

1

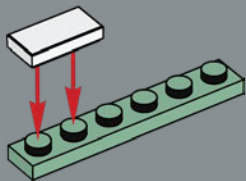

2

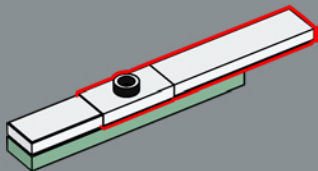

3

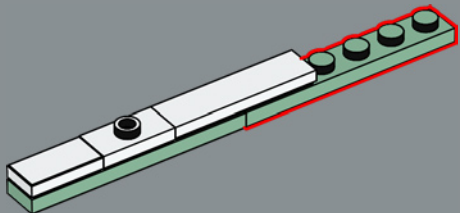

4

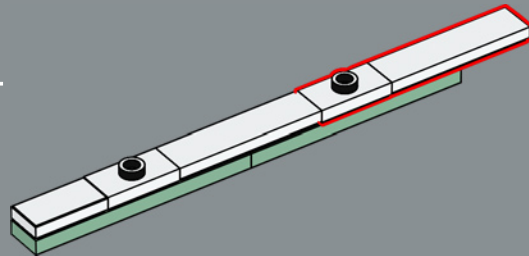

5

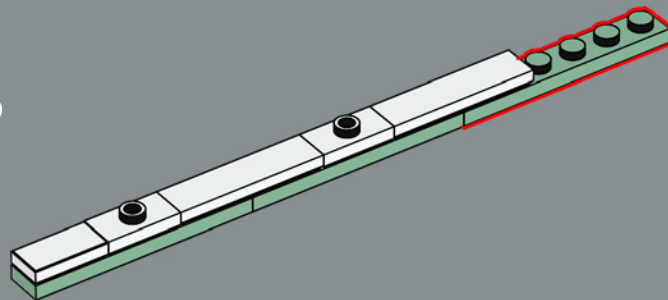

6

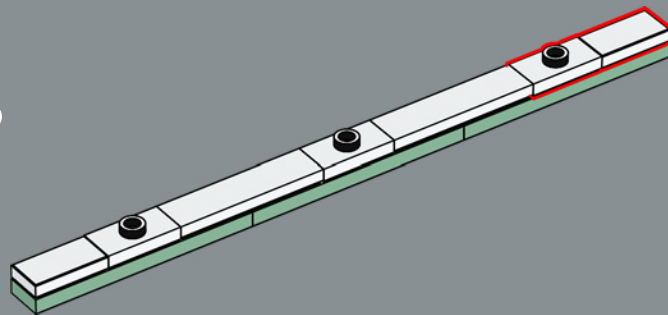



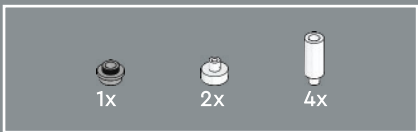

142

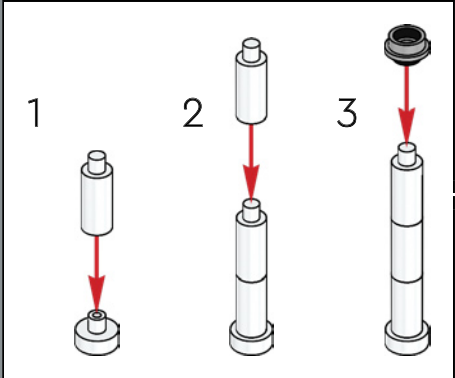

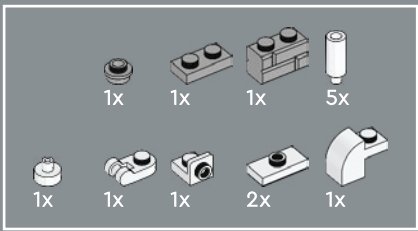

143

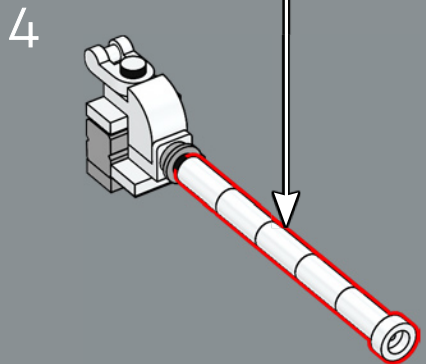
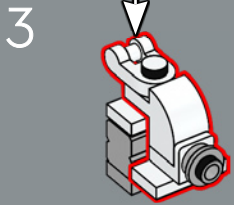
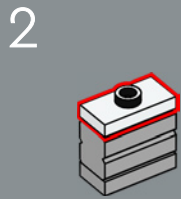
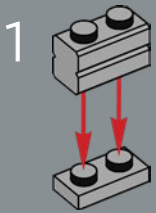
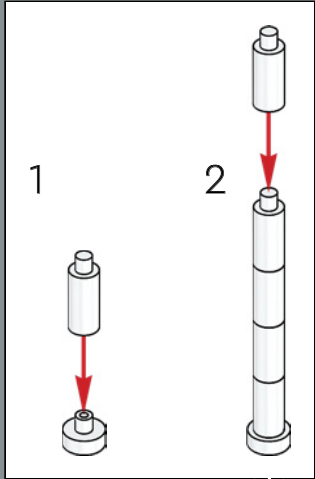
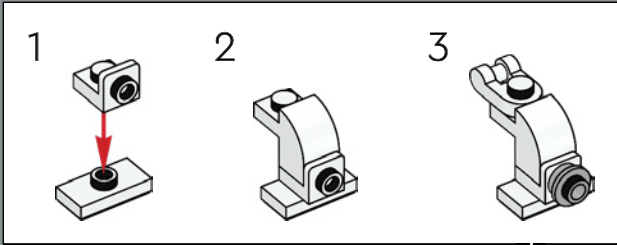

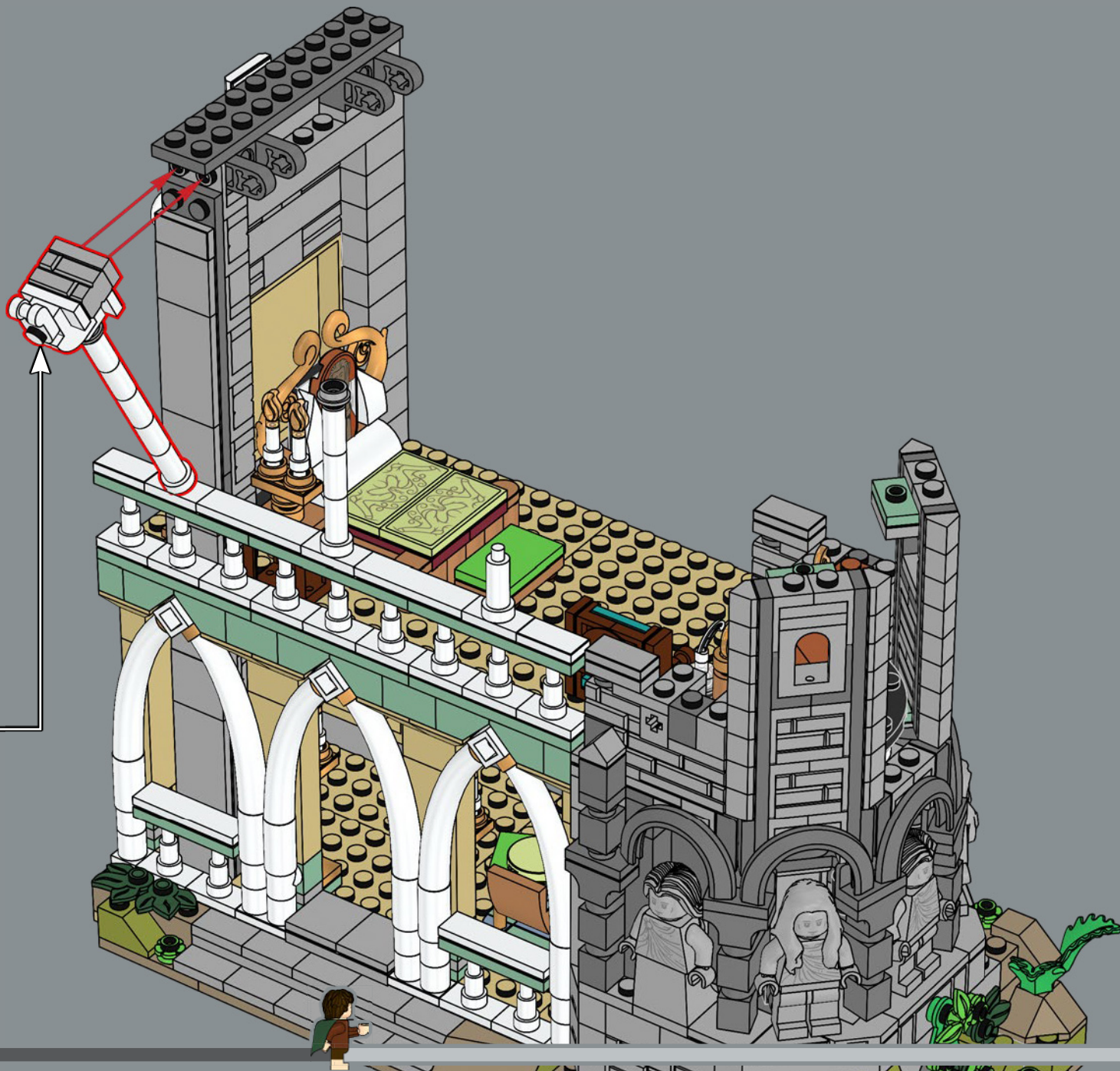

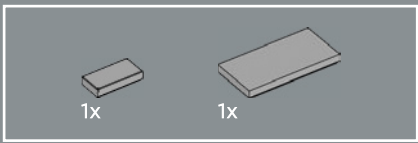

144



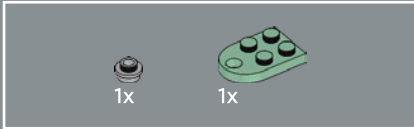
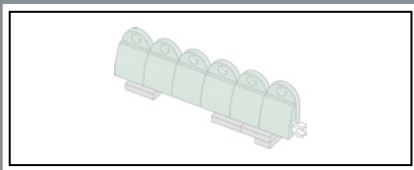

145

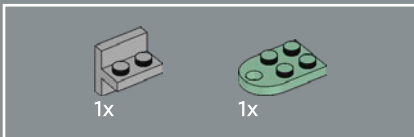
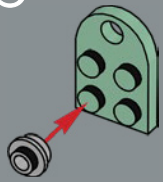

146

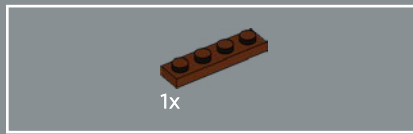
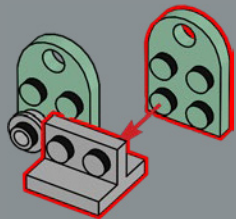

147

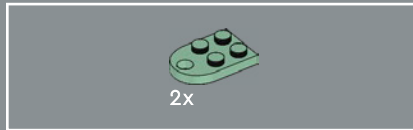
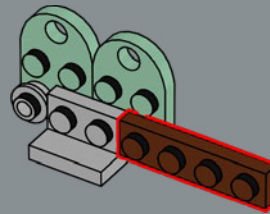

148

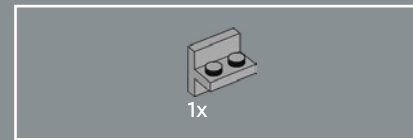
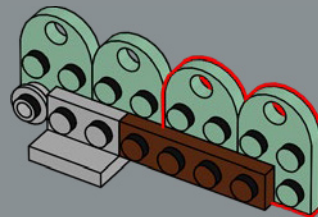

149

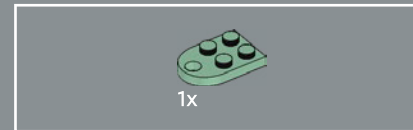
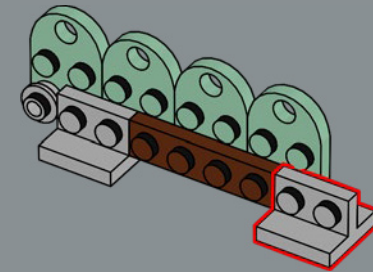

150

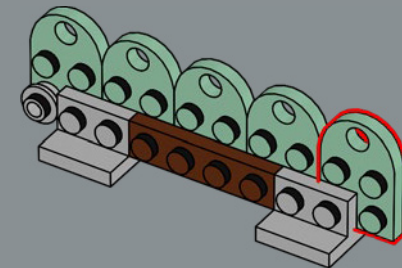

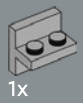

1x

151

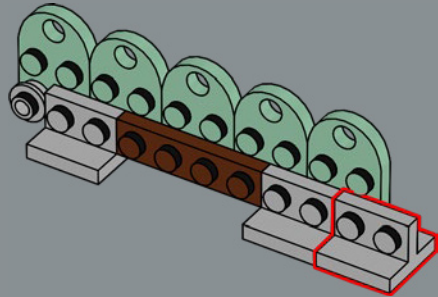

6x

153

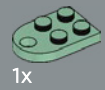
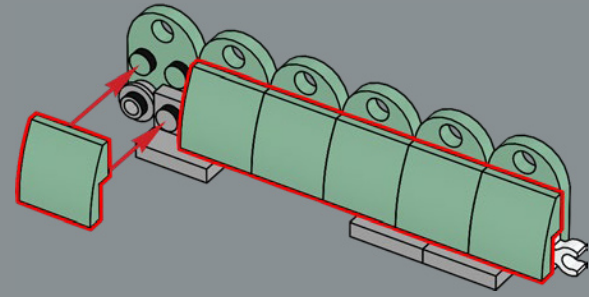

1x



1x

152

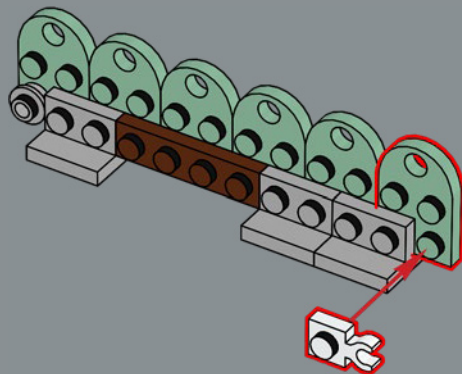

1x

154

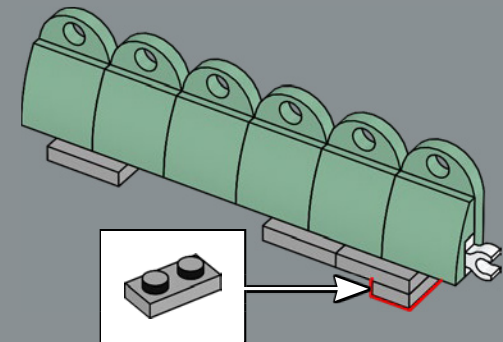

155



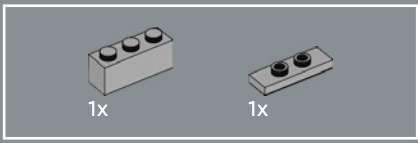

156

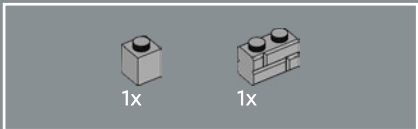
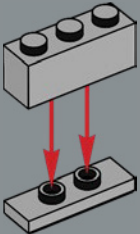

157

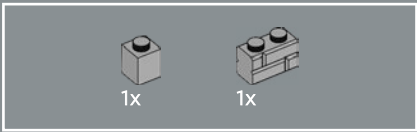
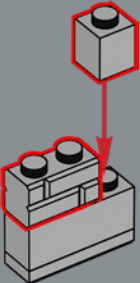

158

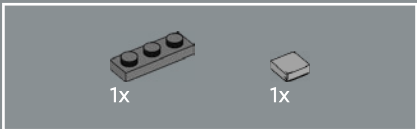
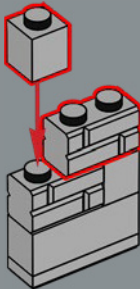

159

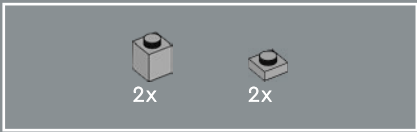
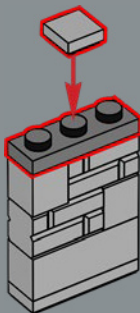

160

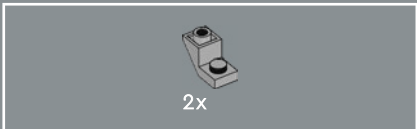
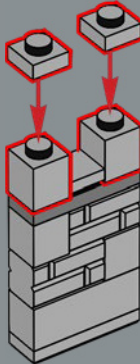

161

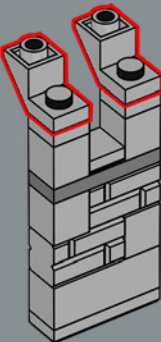

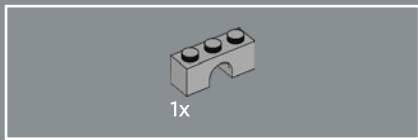

162

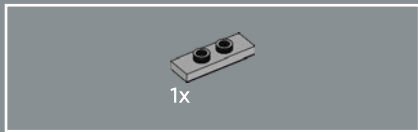
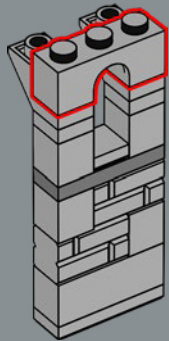

163

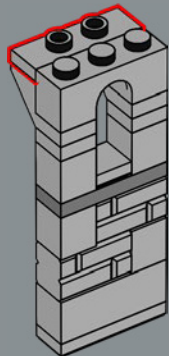

164

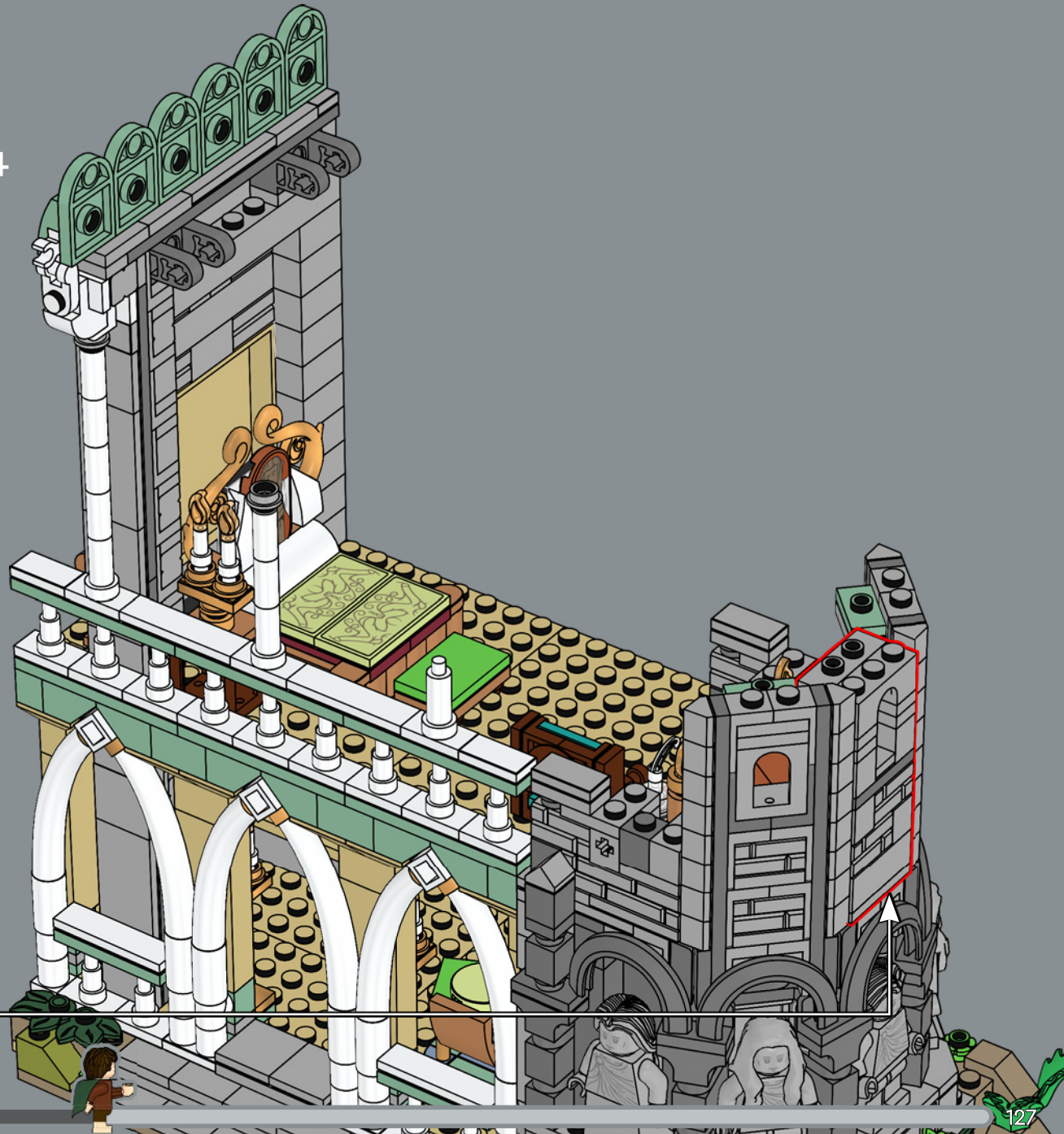

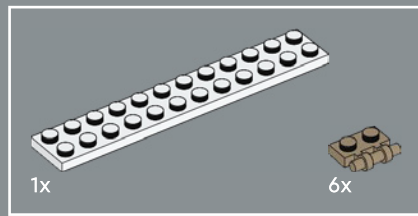

165

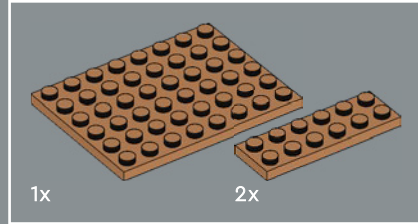
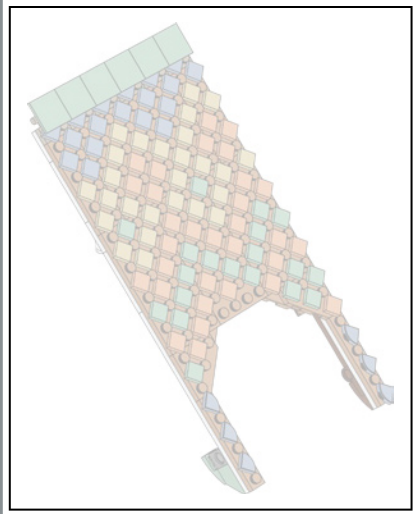
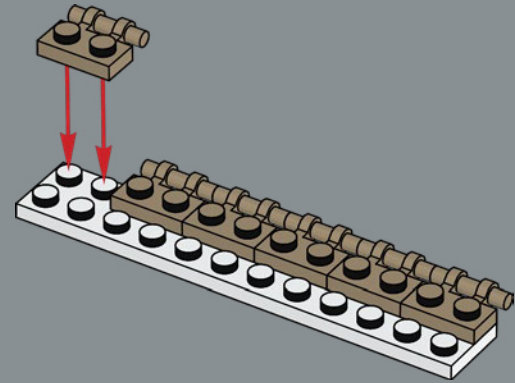

166

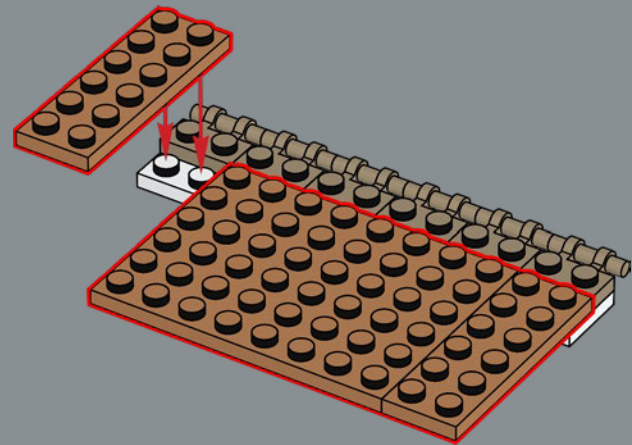

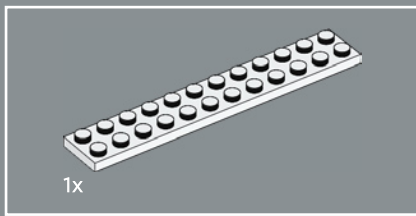

167

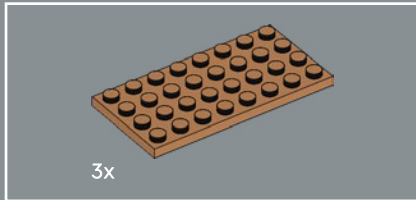
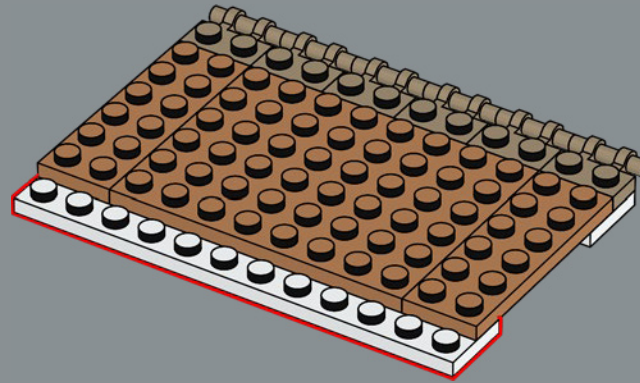

168

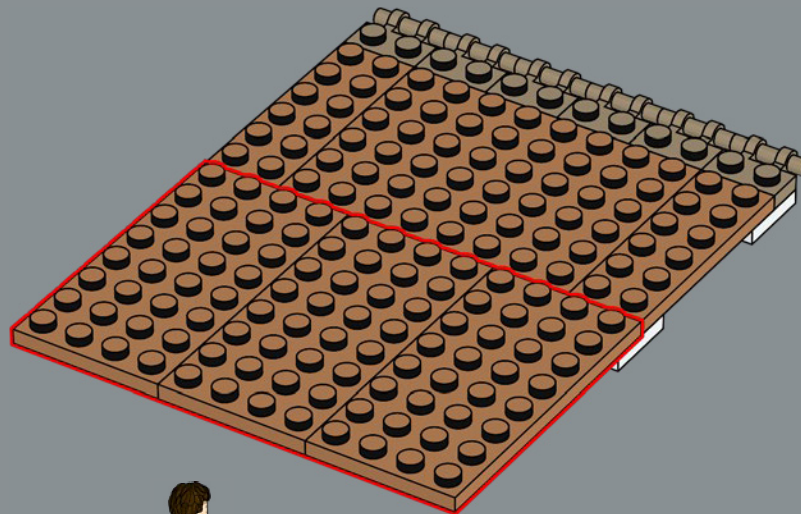

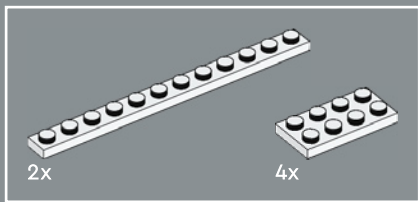

169

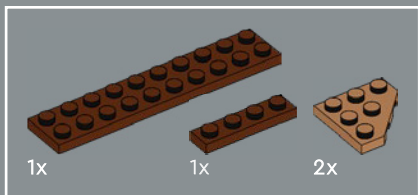
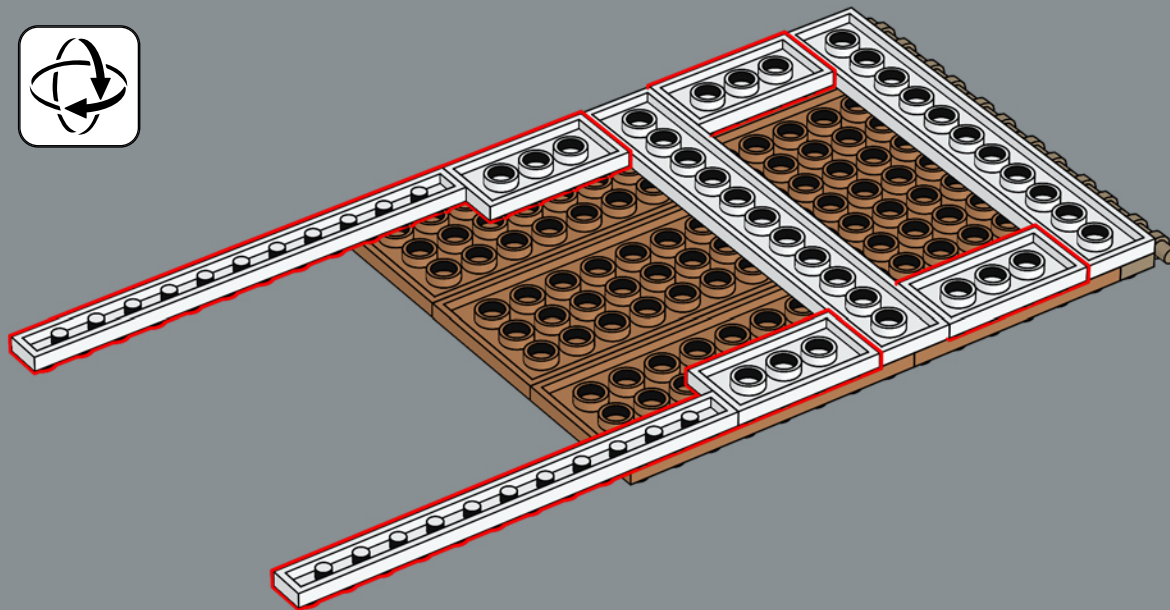

170

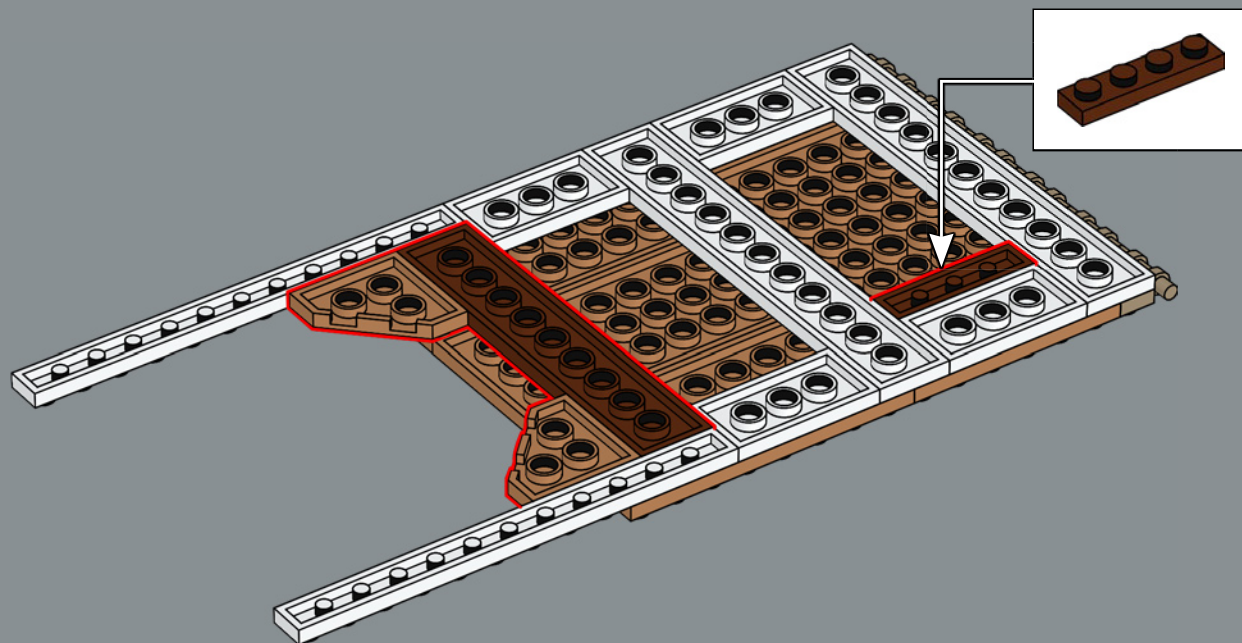

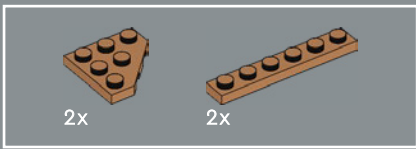

171

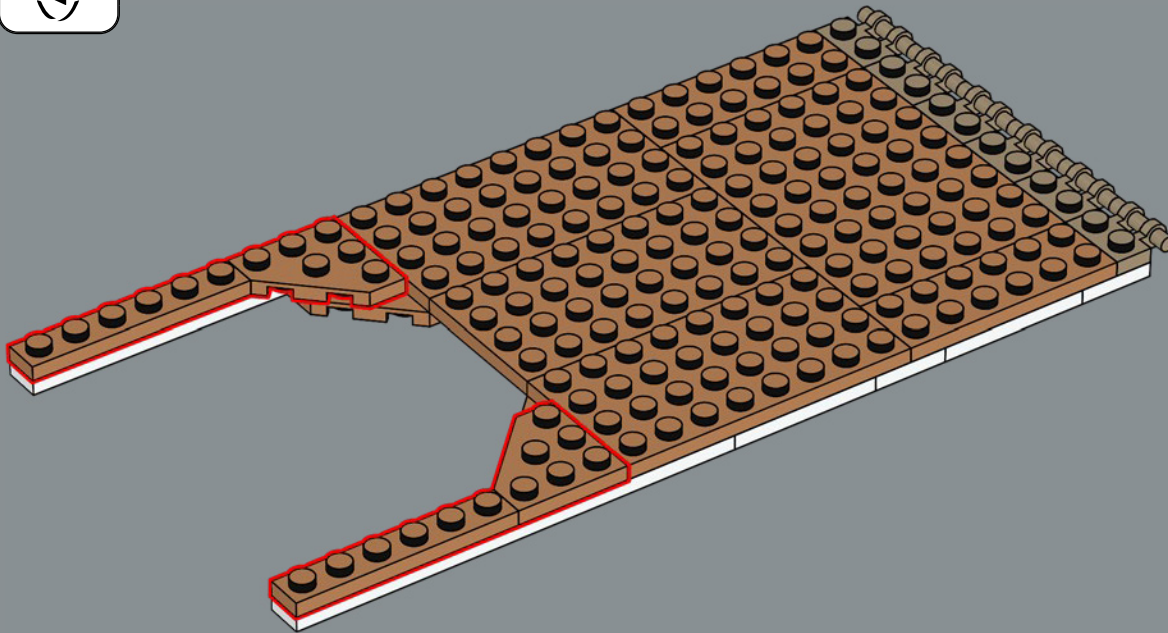



18x



172

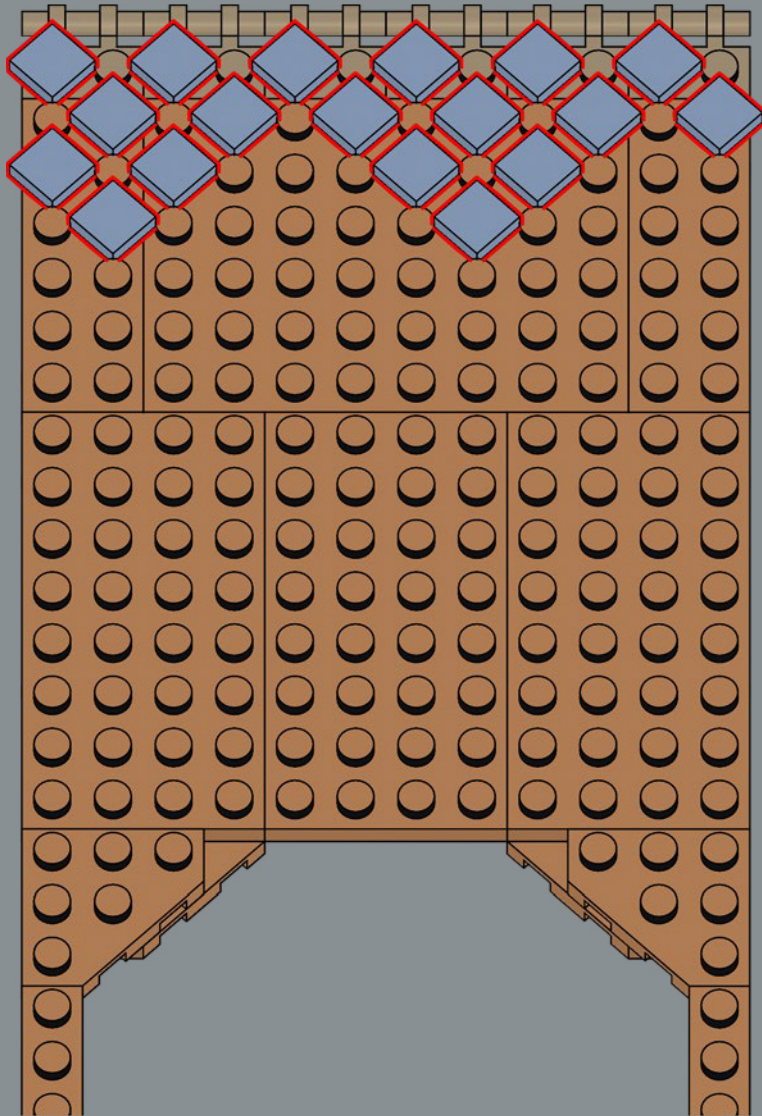

12x



8x

173

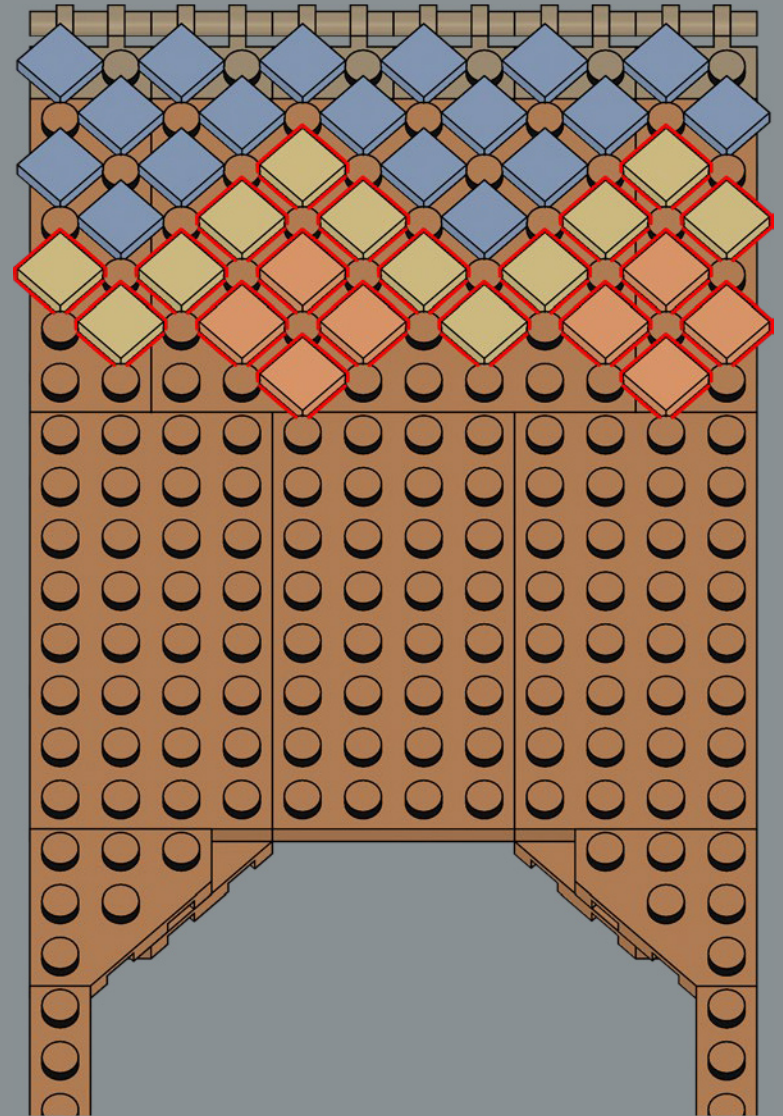

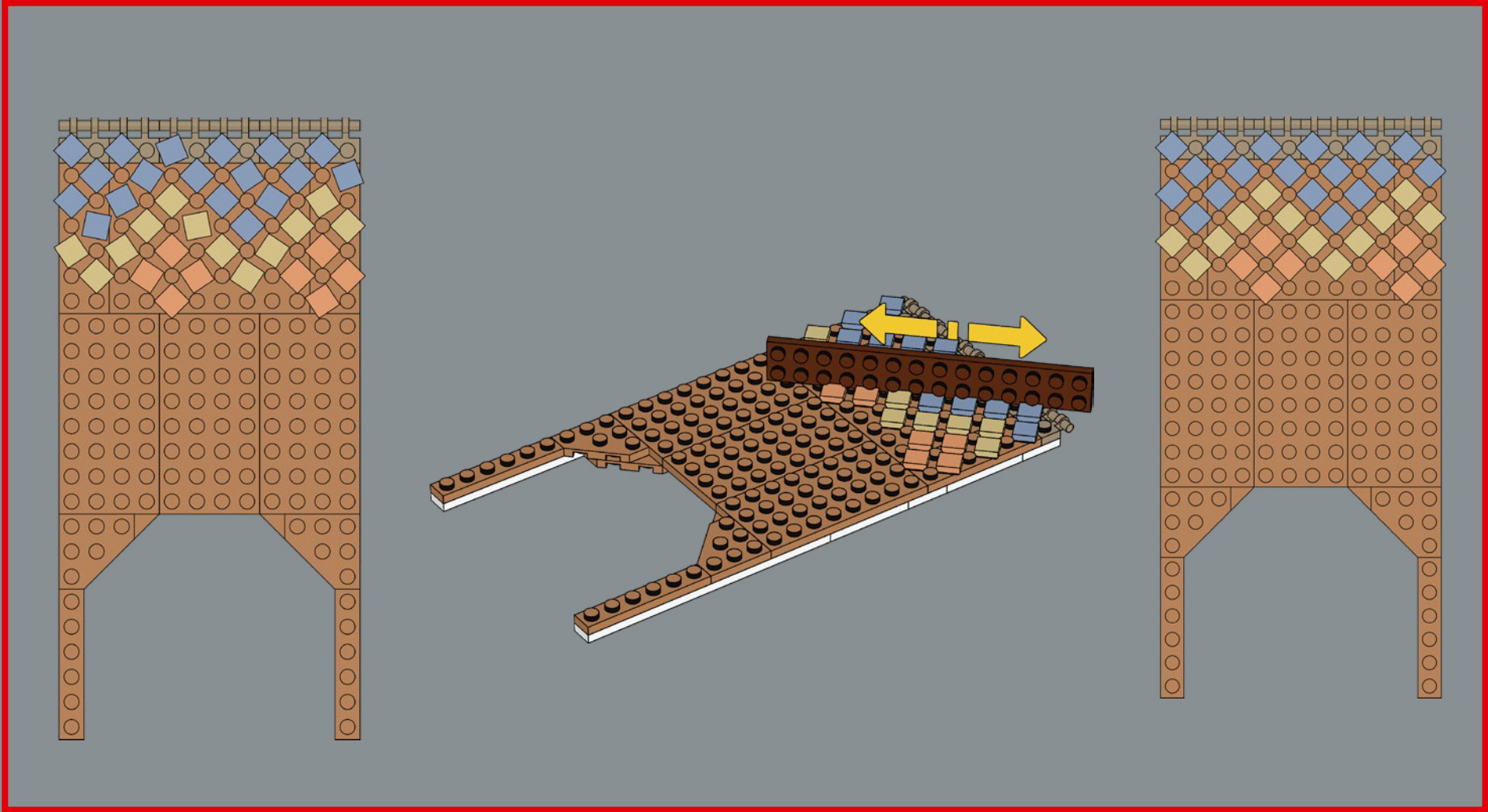



174

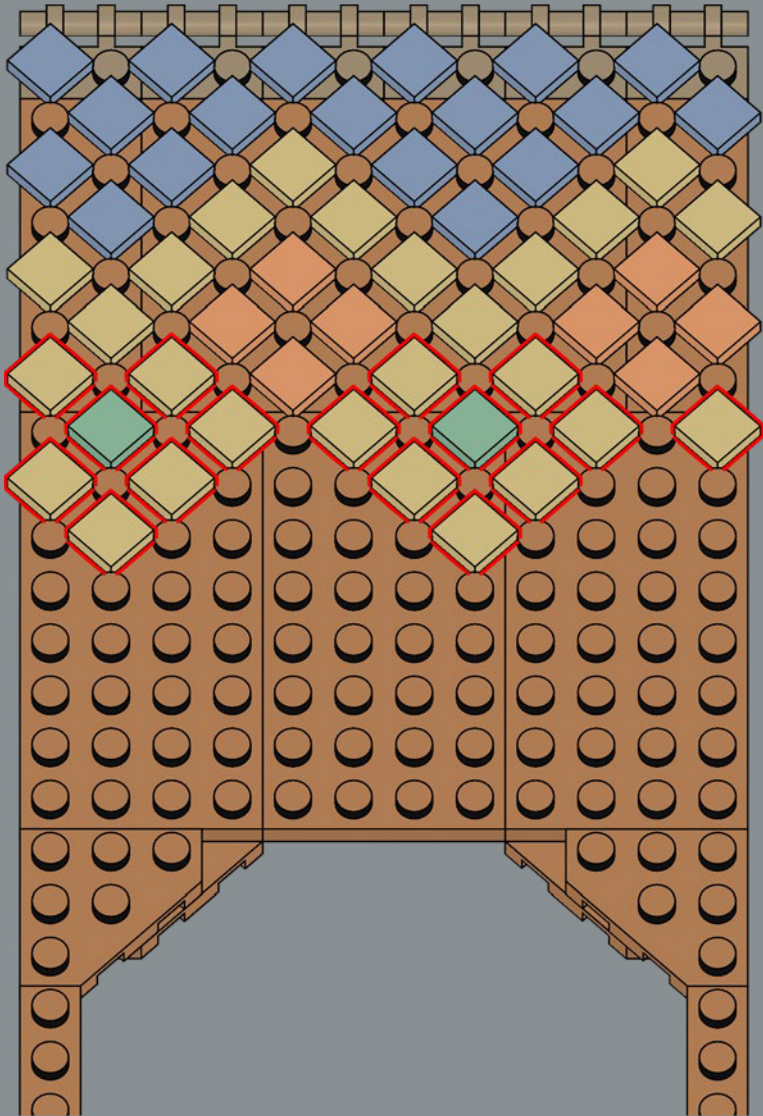

175

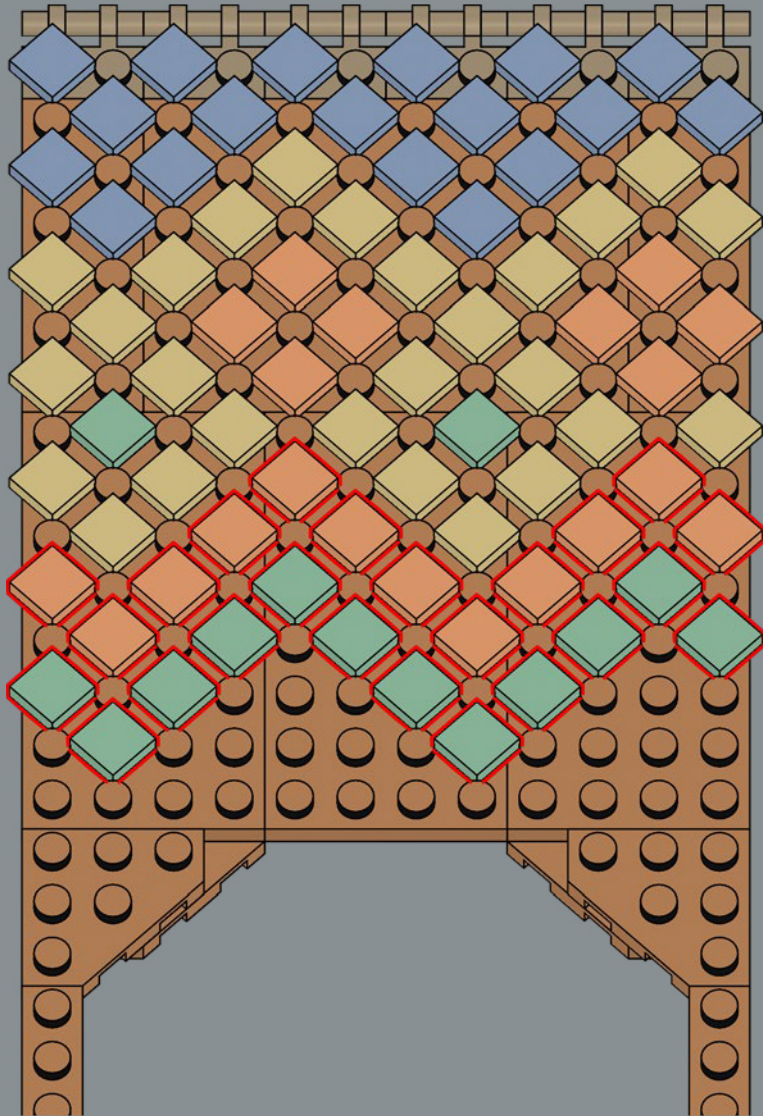



 5x	 6x	 11x
--	--	---

176

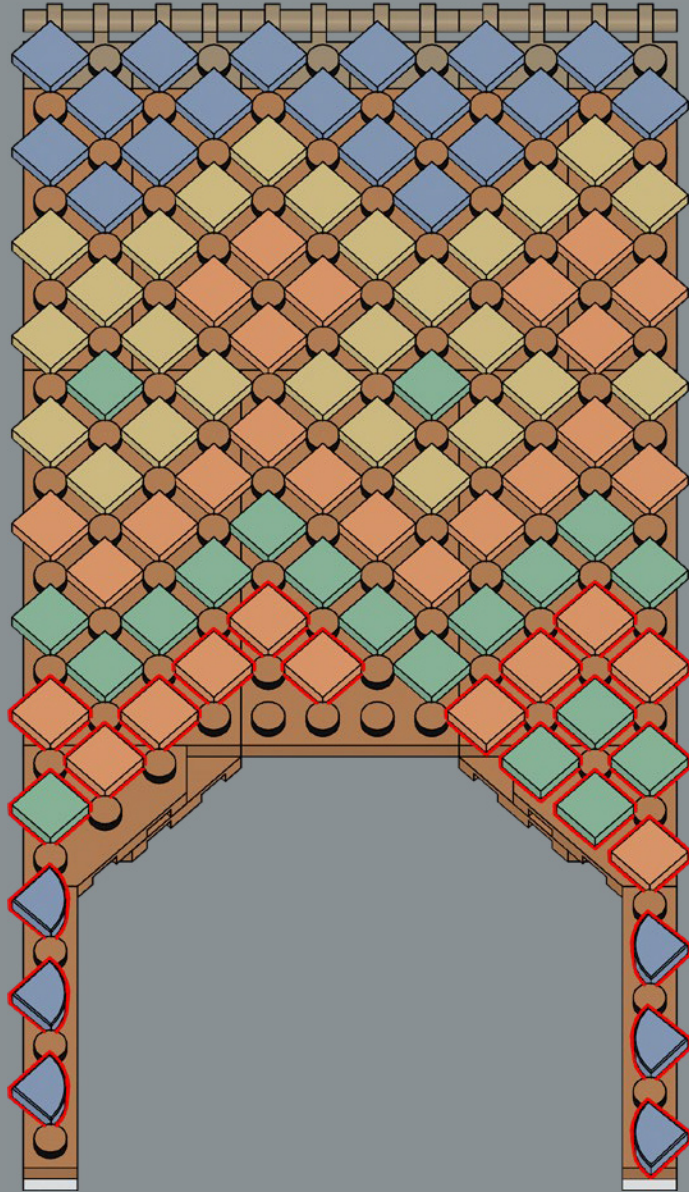

Chacune des 94 tuiles 1x1 du toit doit être installée à un angle de 45 degrés. La meilleure façon de les aligner est de passer une grande plaque ou tuile à travers les rainures lorsque tous les éléments sont en place.





6x

177

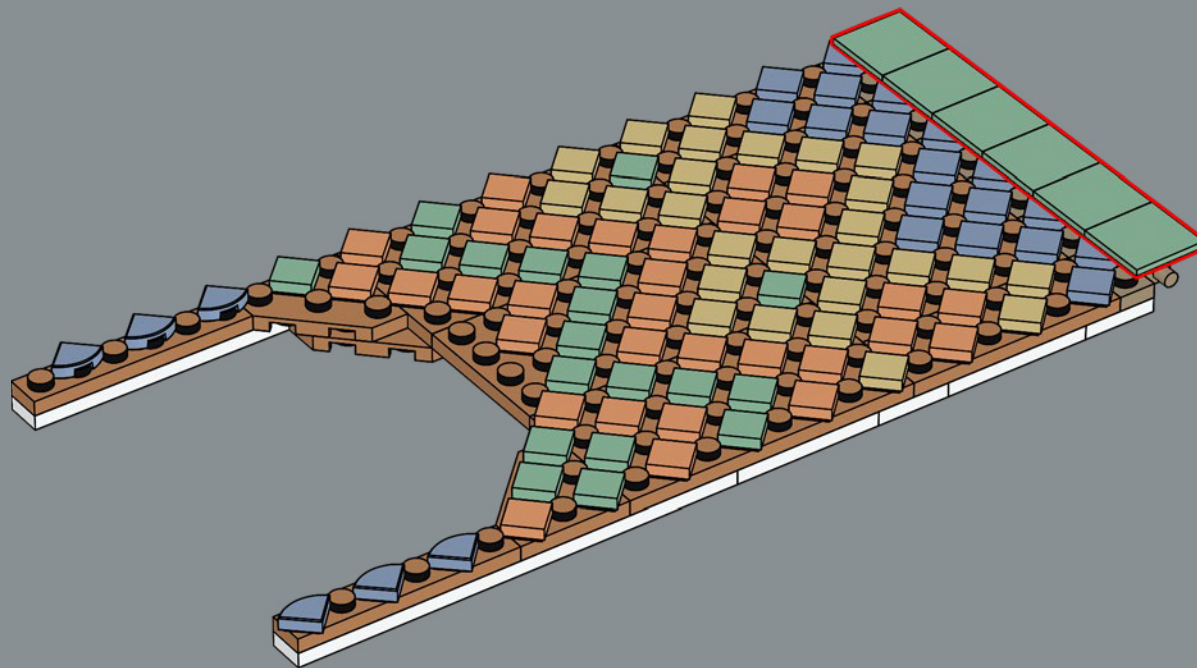

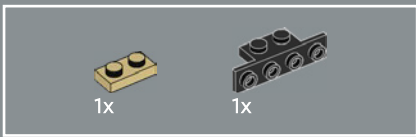

178

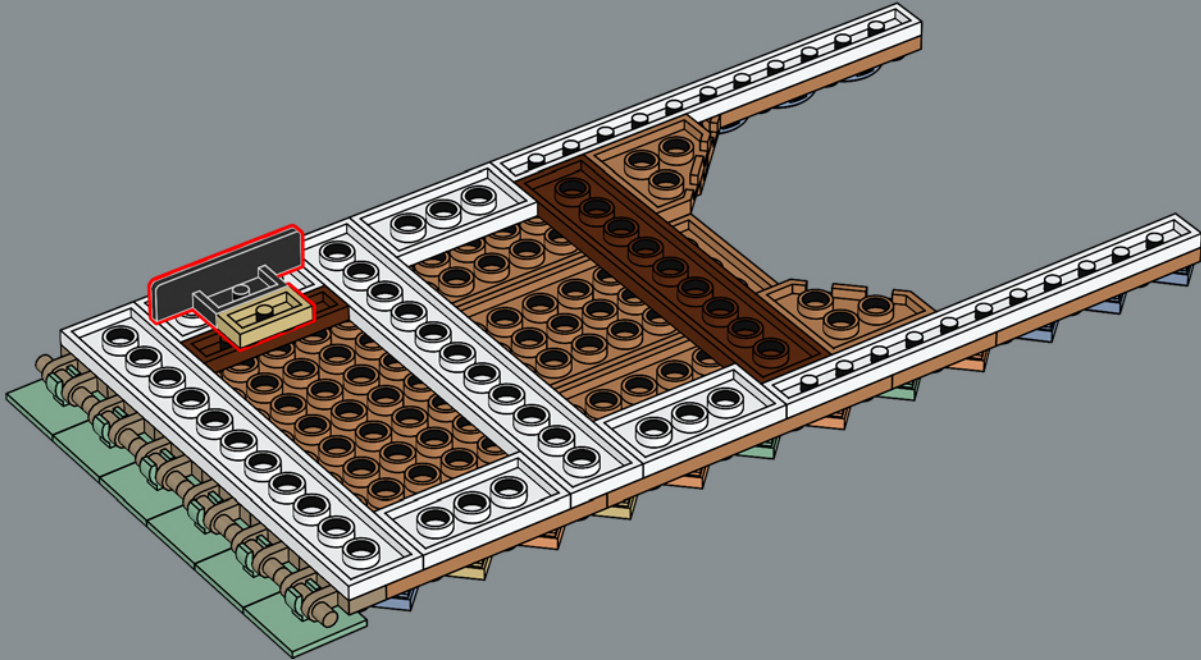



179

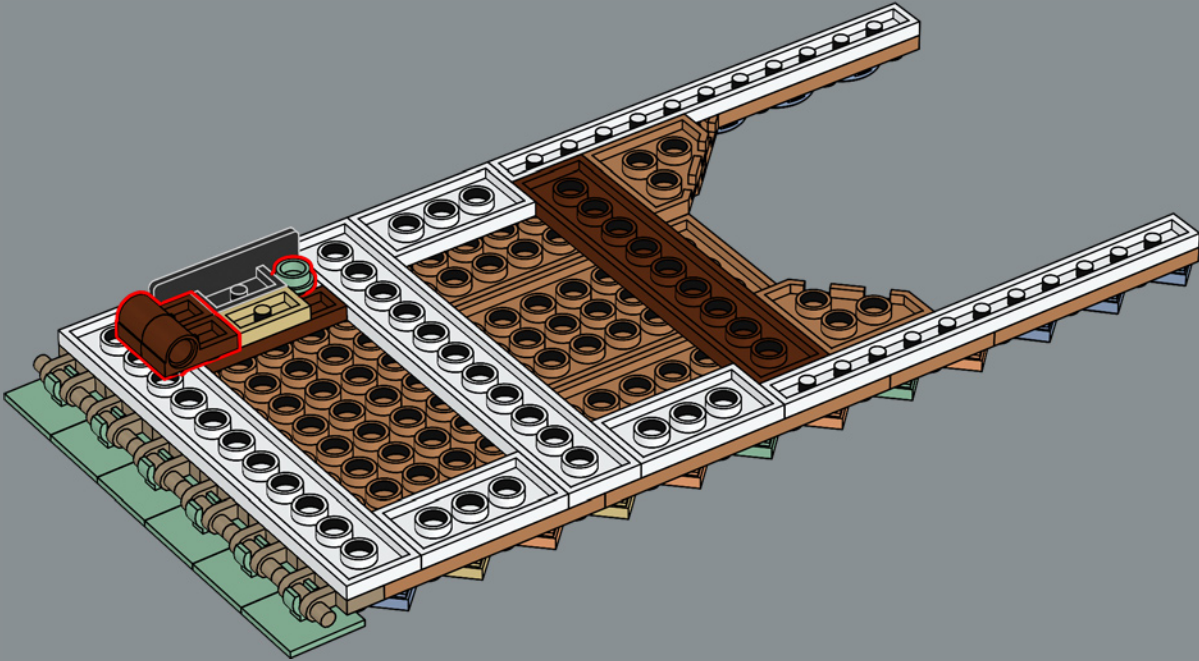

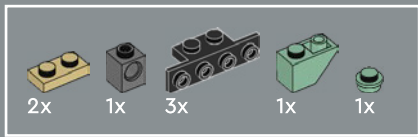

180

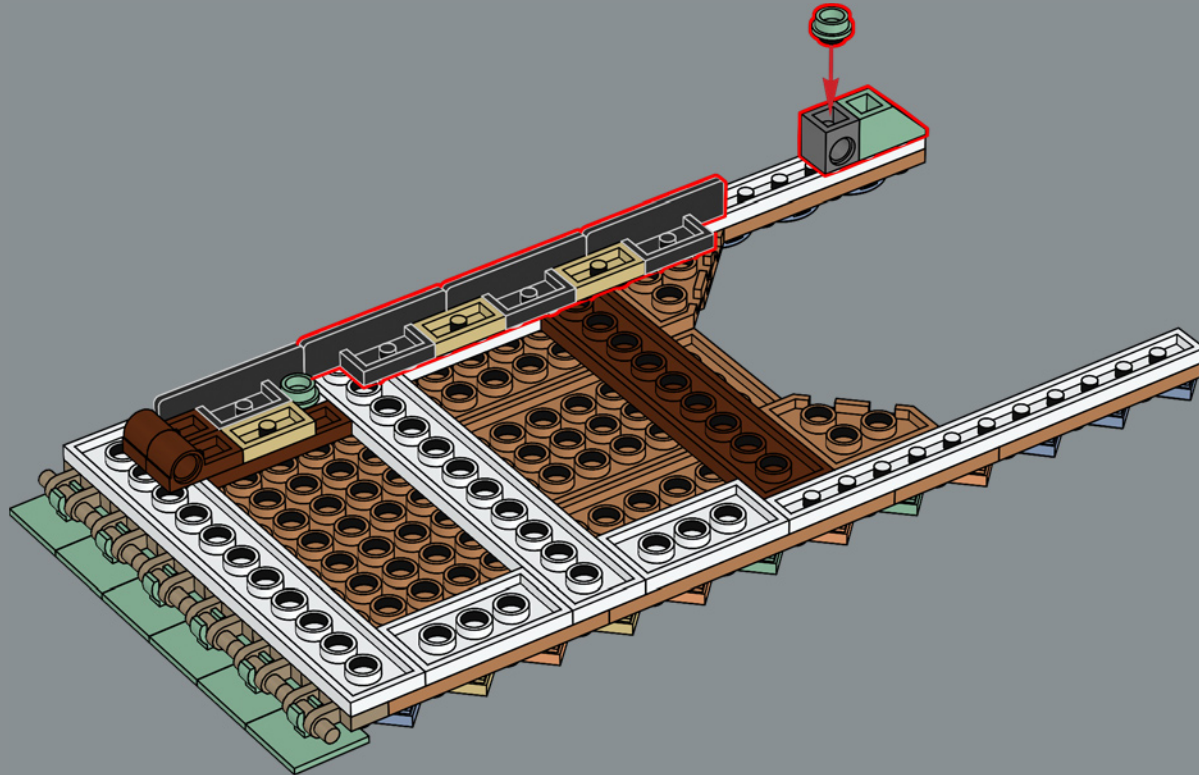

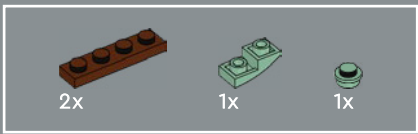

181

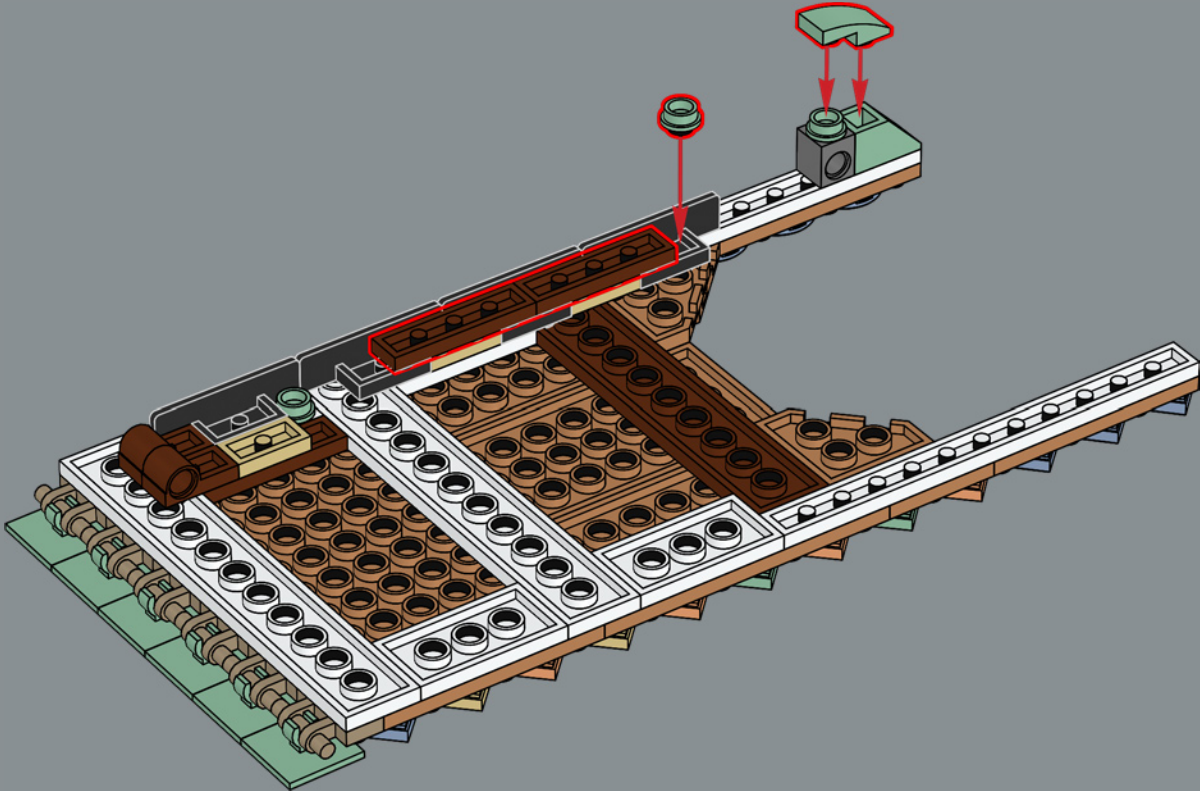

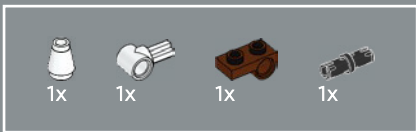

182

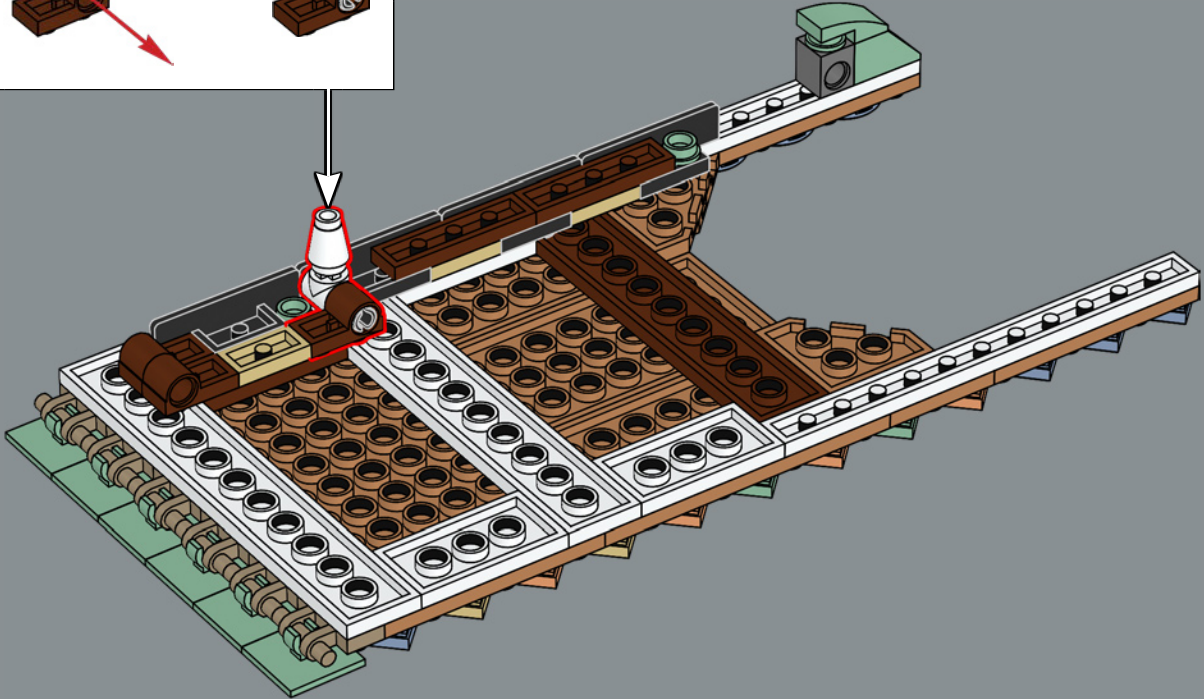
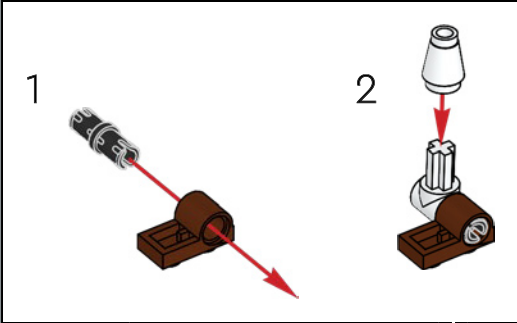

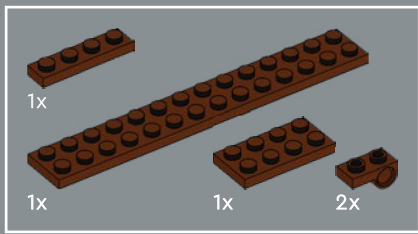

183

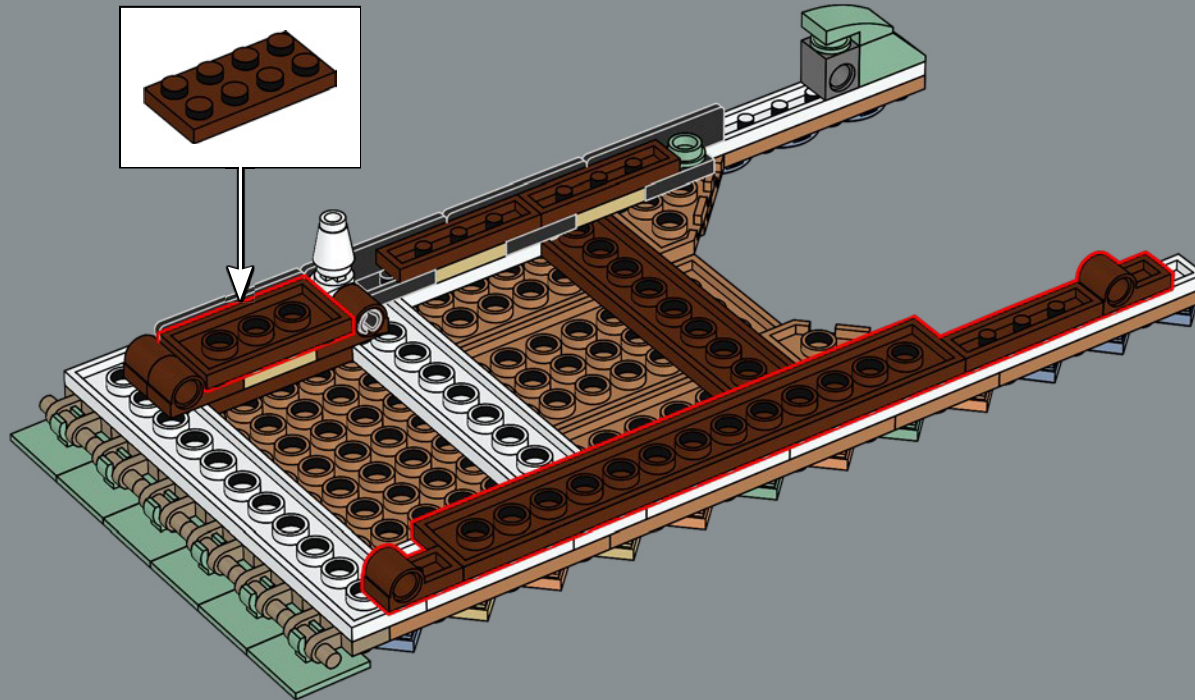

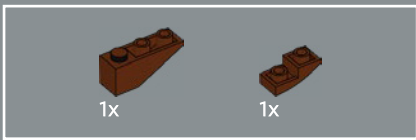

184

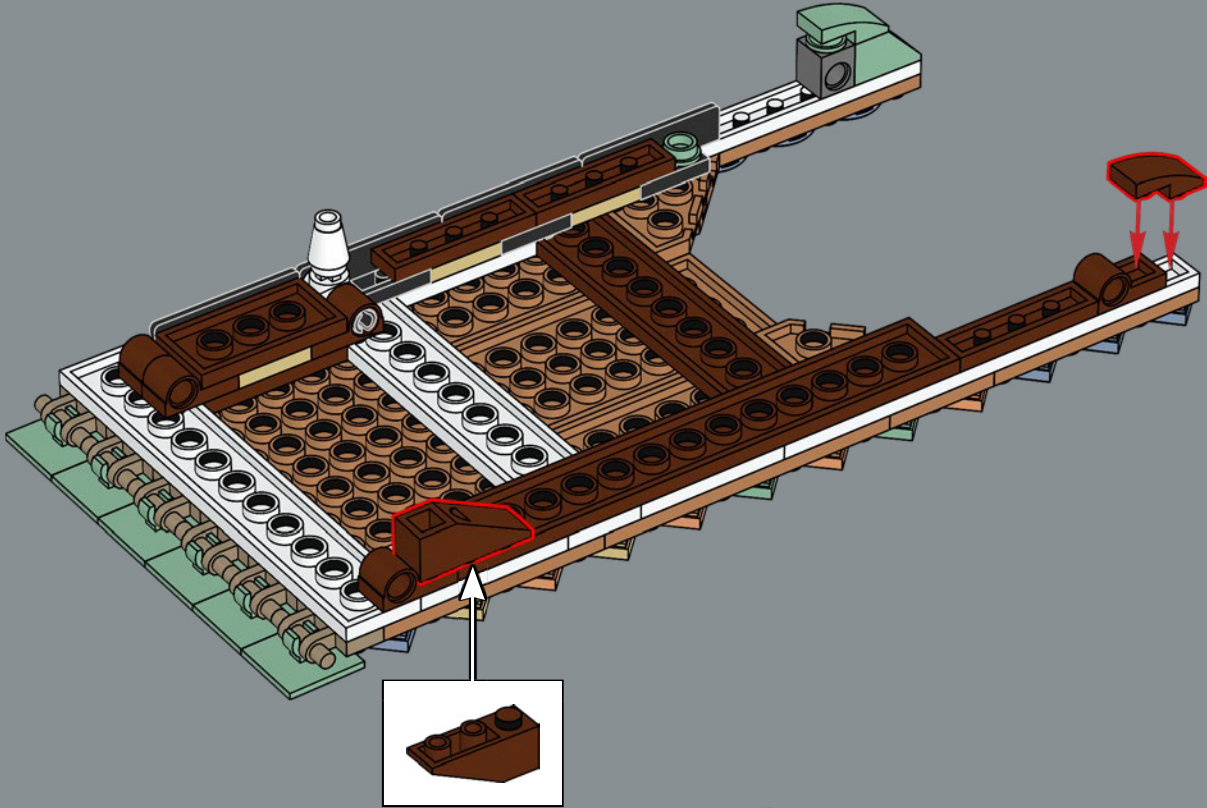

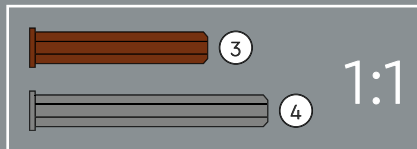
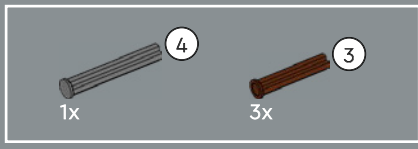

185

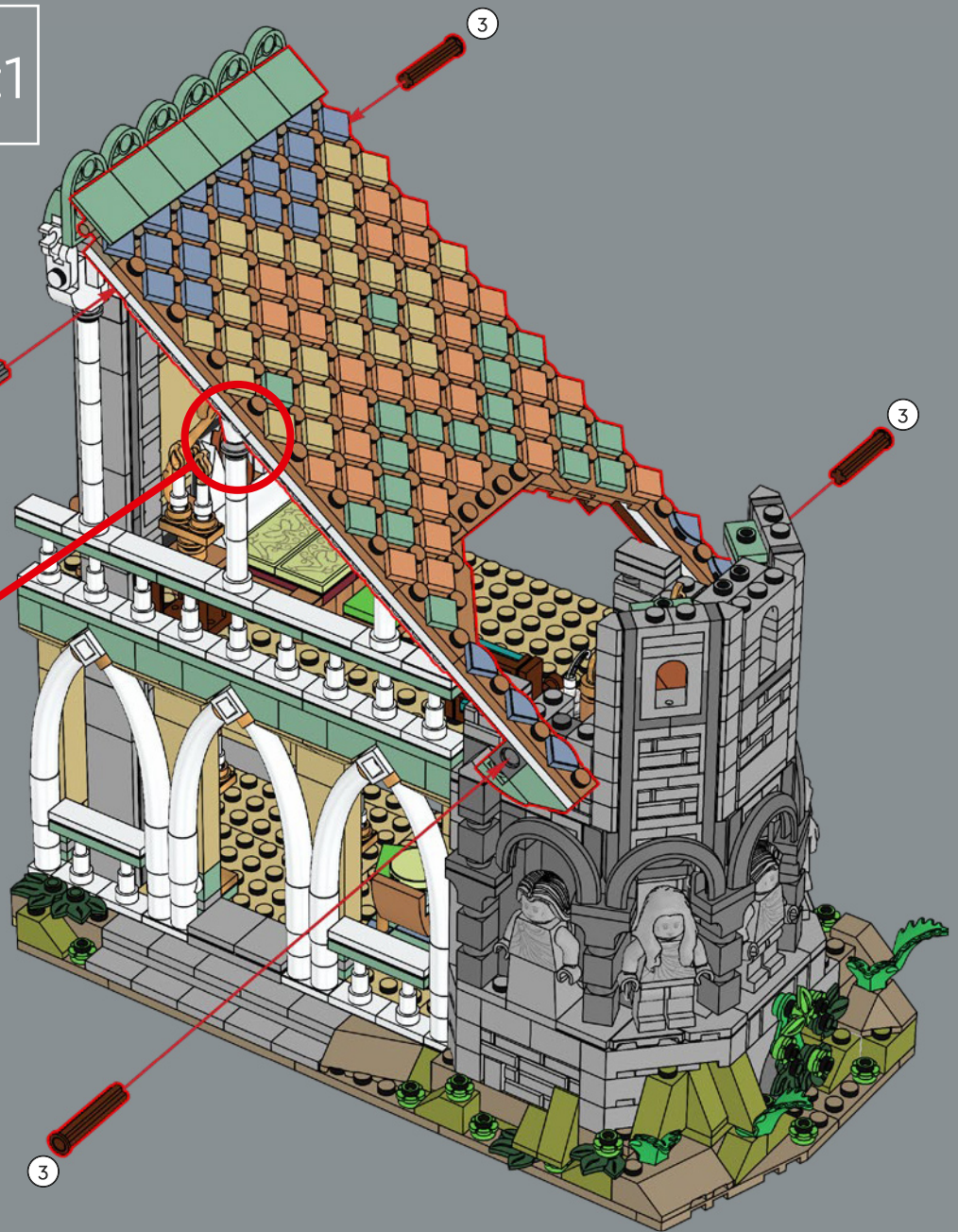
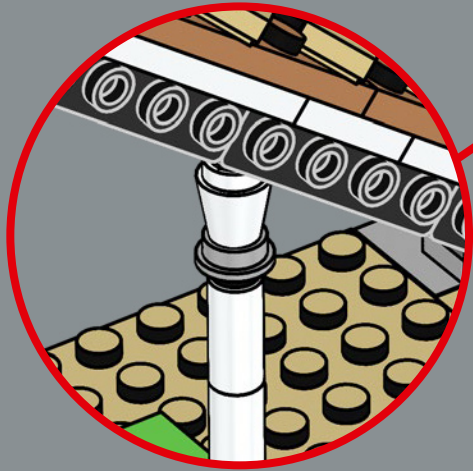
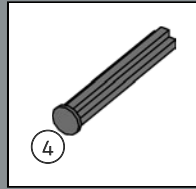

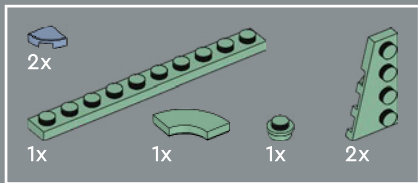

186

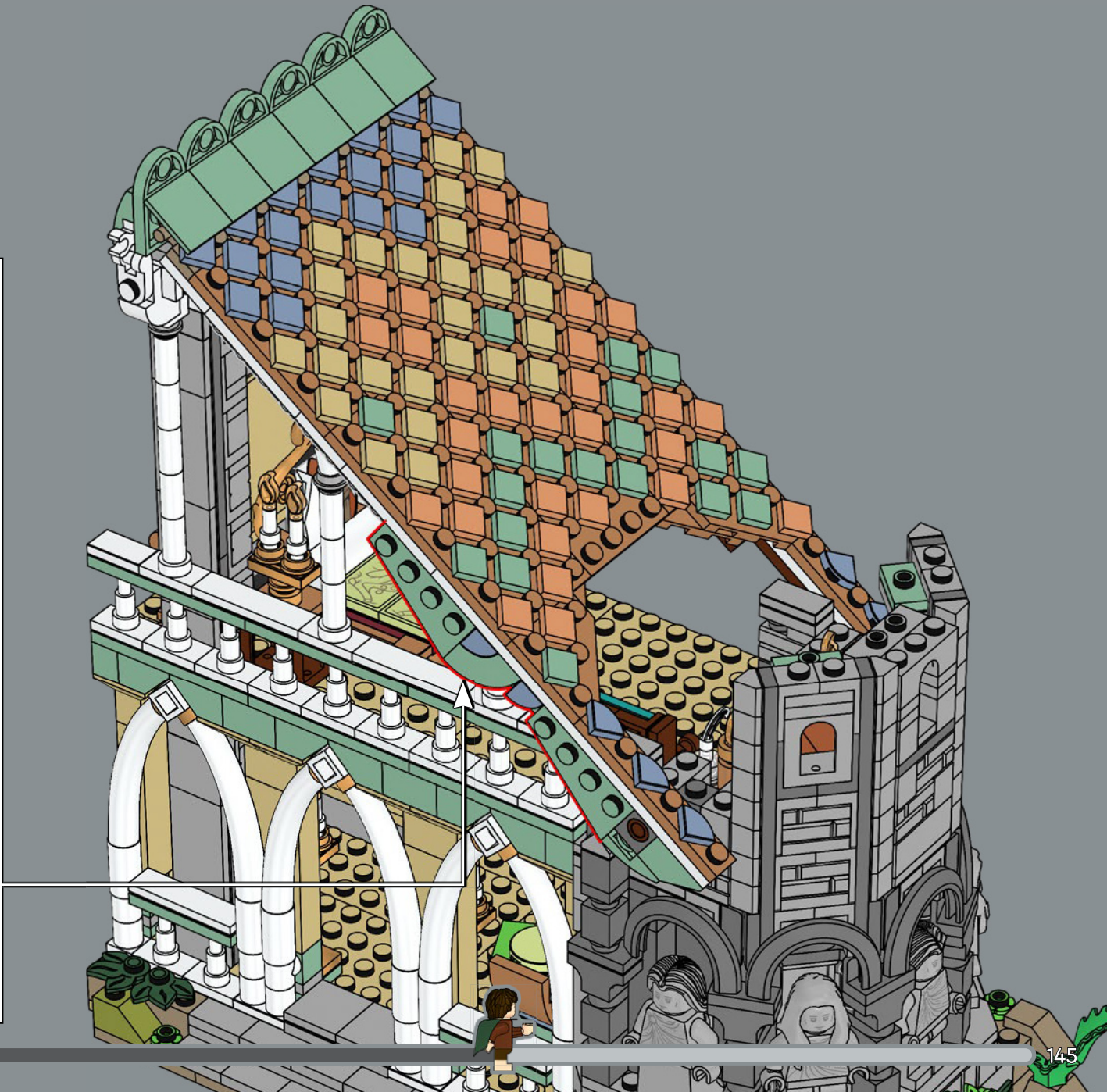
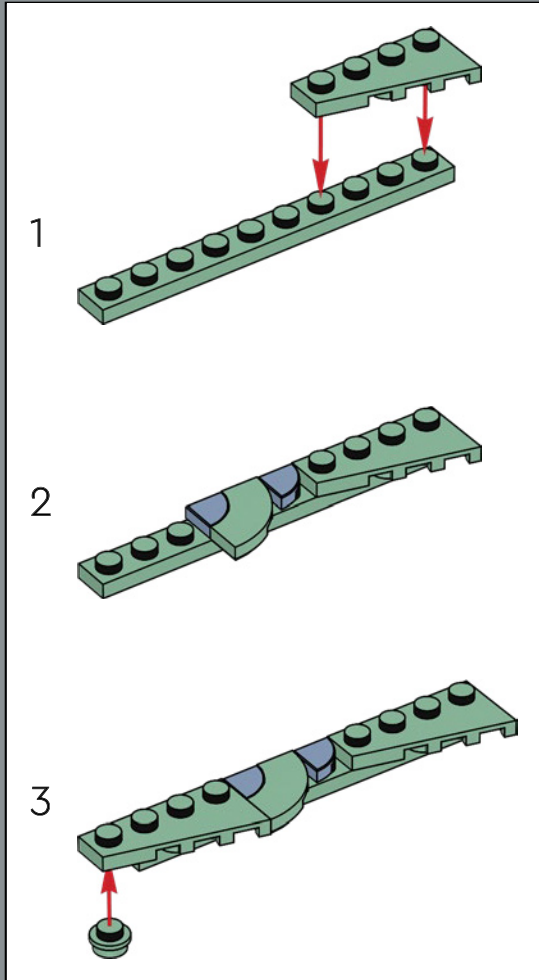

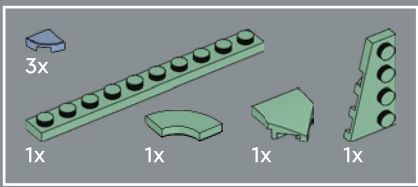

187

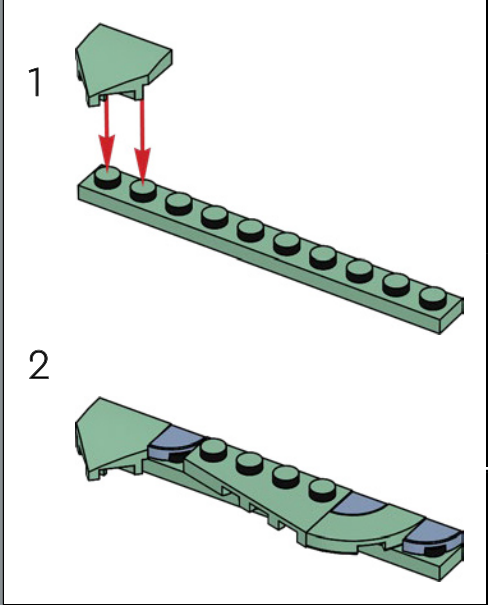

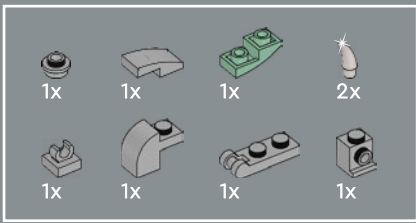

188

1

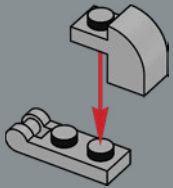

2

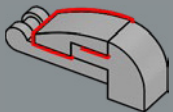

3

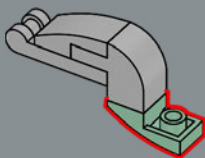

4

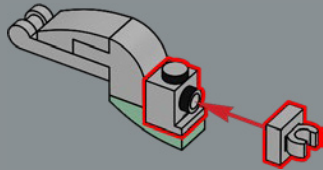

5

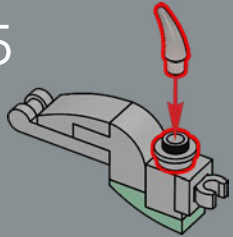

6

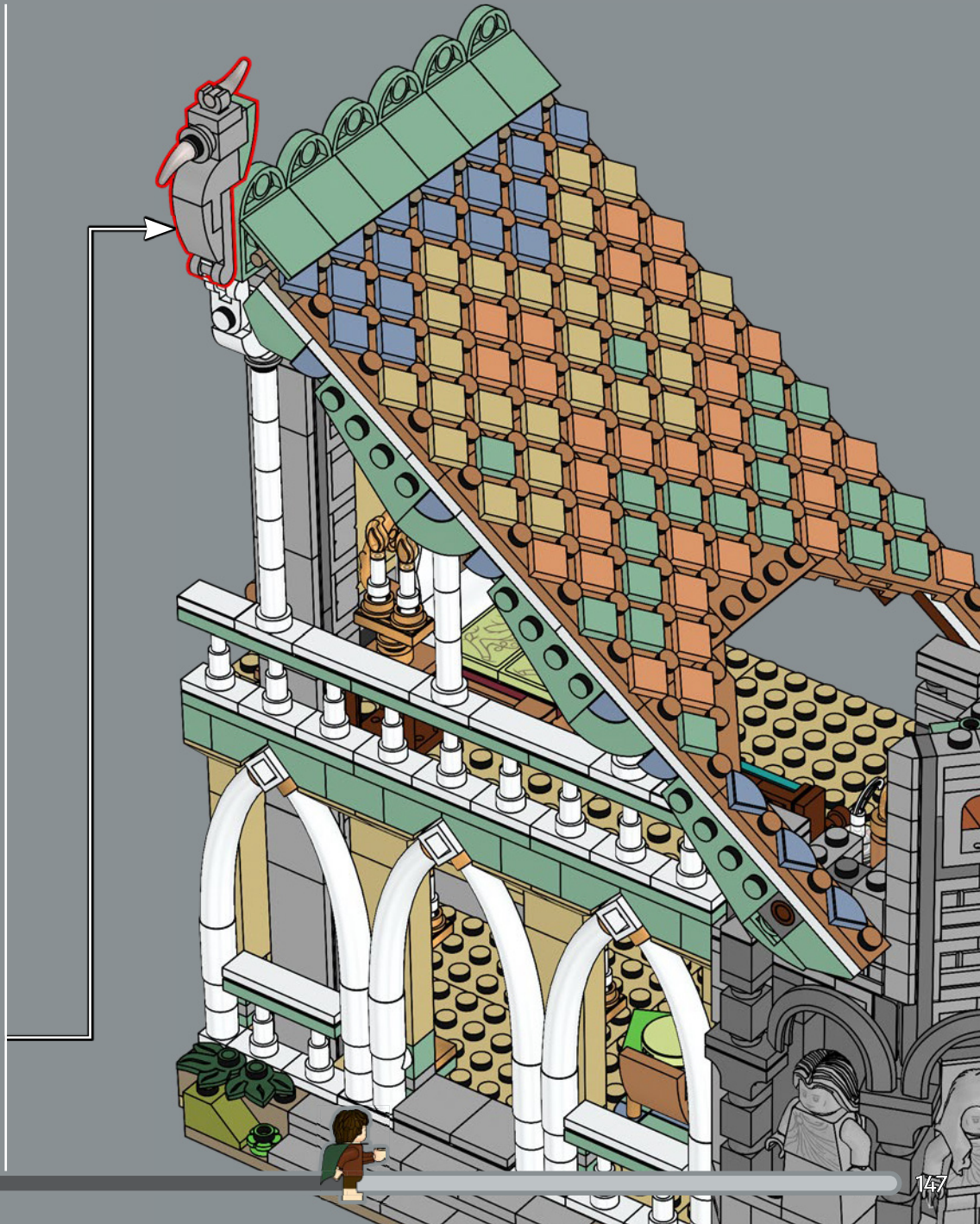
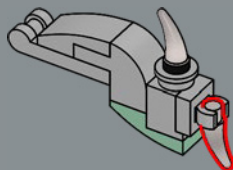

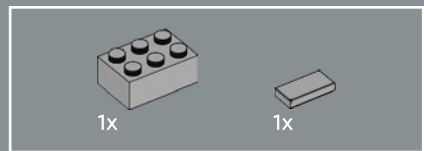

189

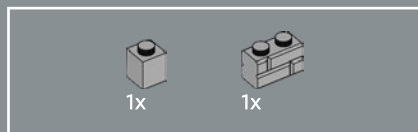
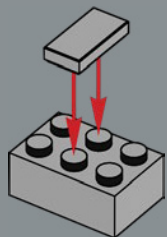

190

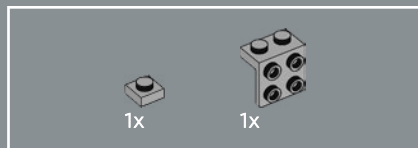
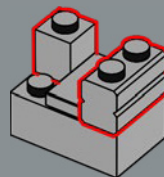

191

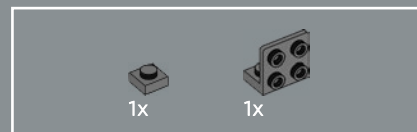
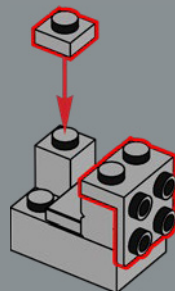

192

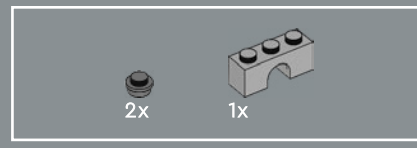
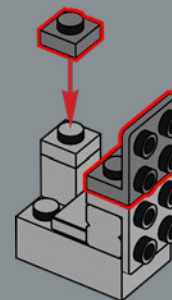

193

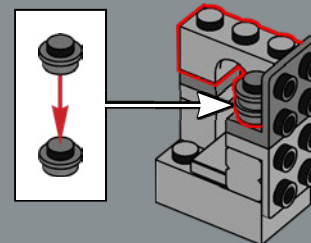

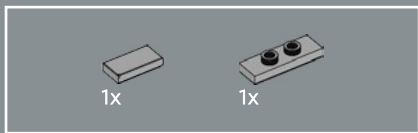

194

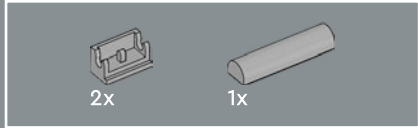
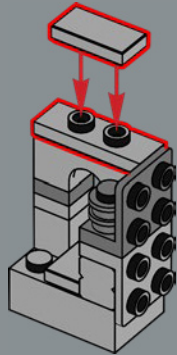

195

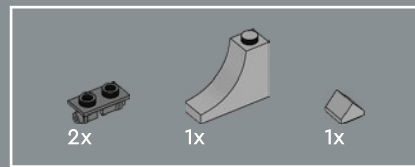
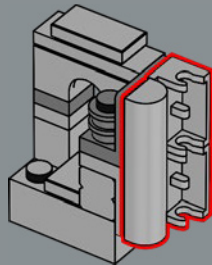

196

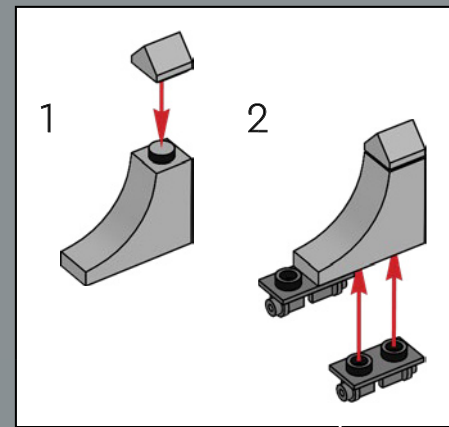
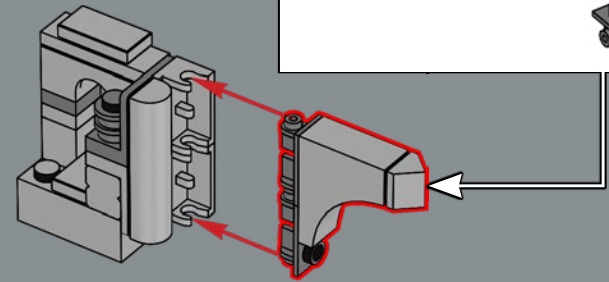

197

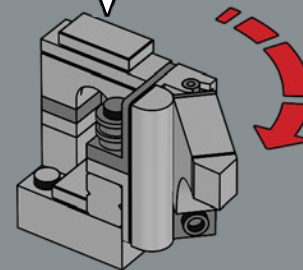

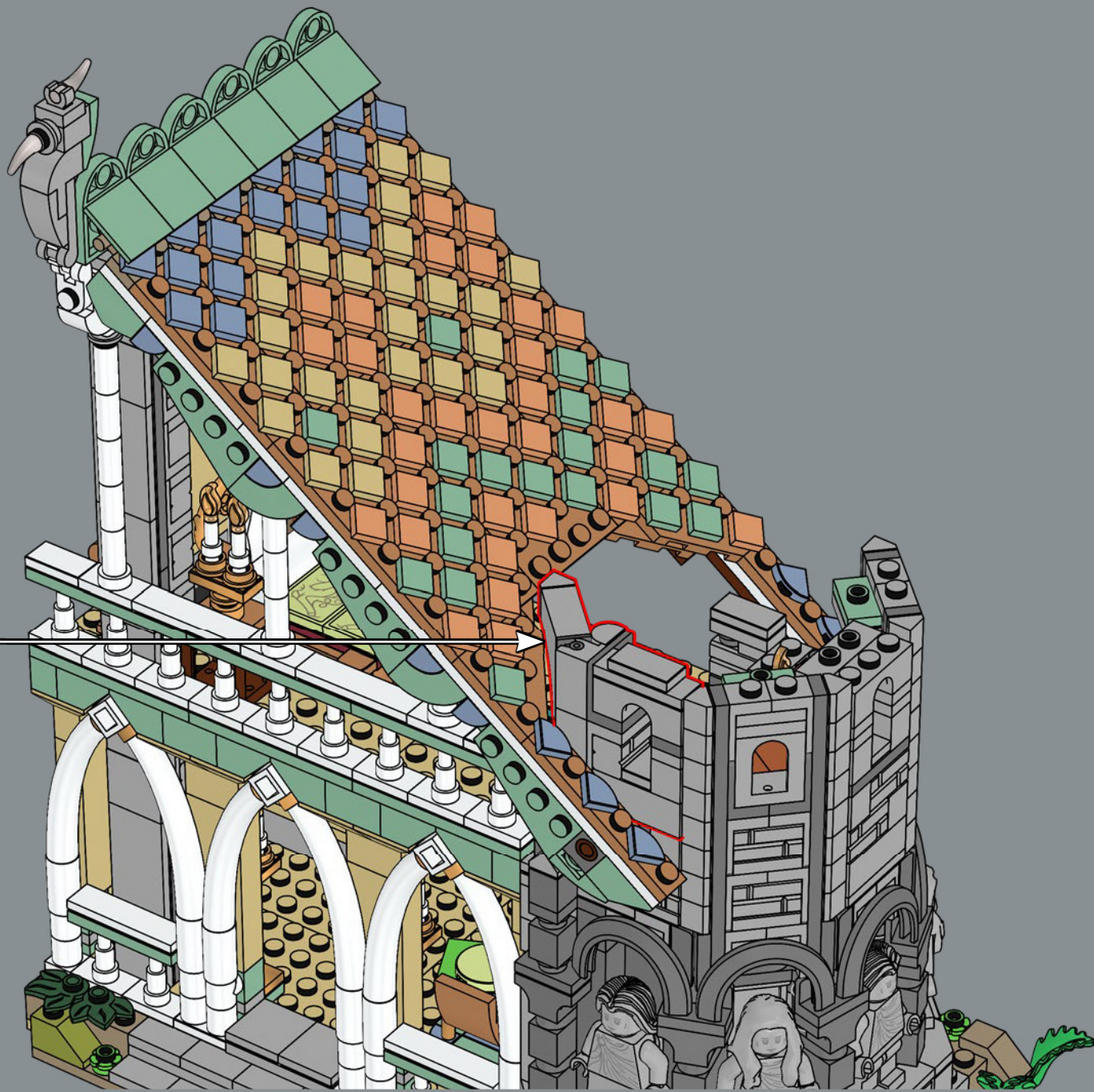

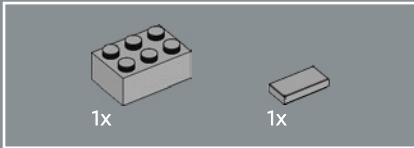
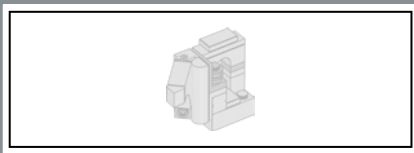

199

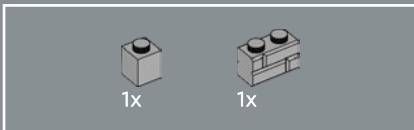
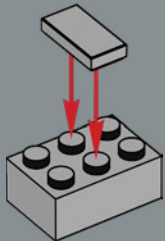

200

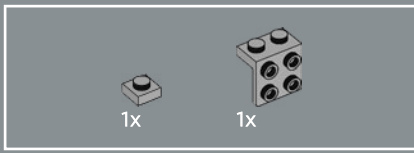
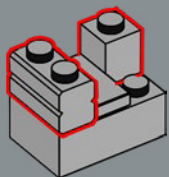

201

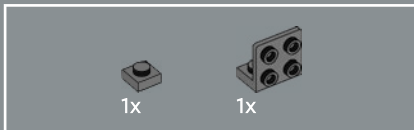
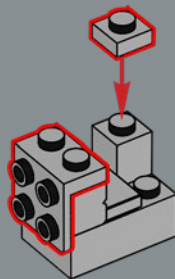

202

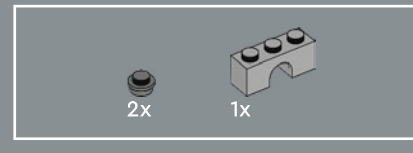
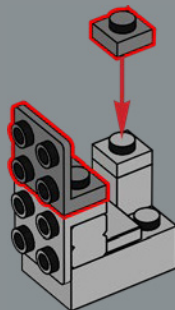

203

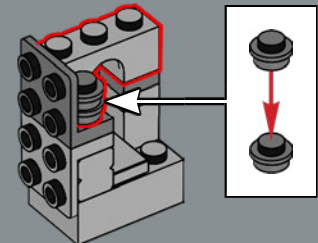

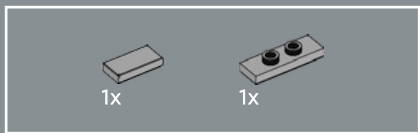

204

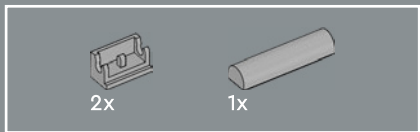
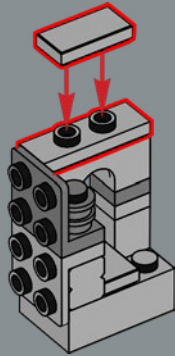

205

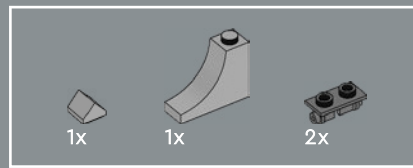
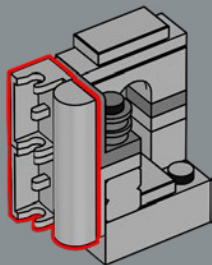

206

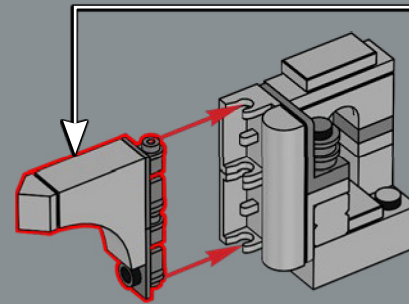
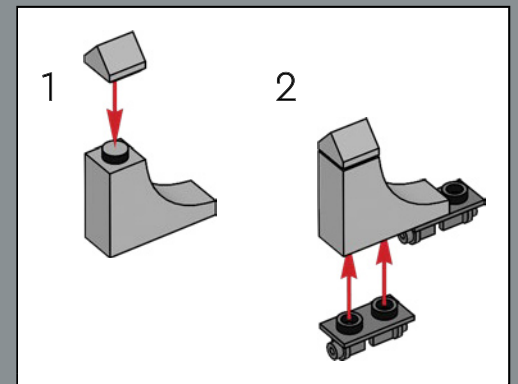

207

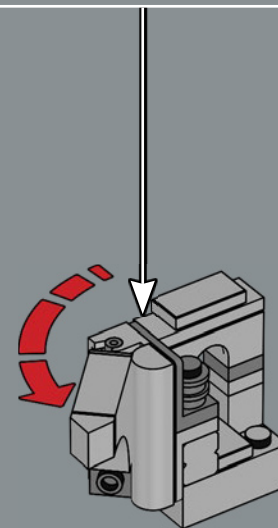

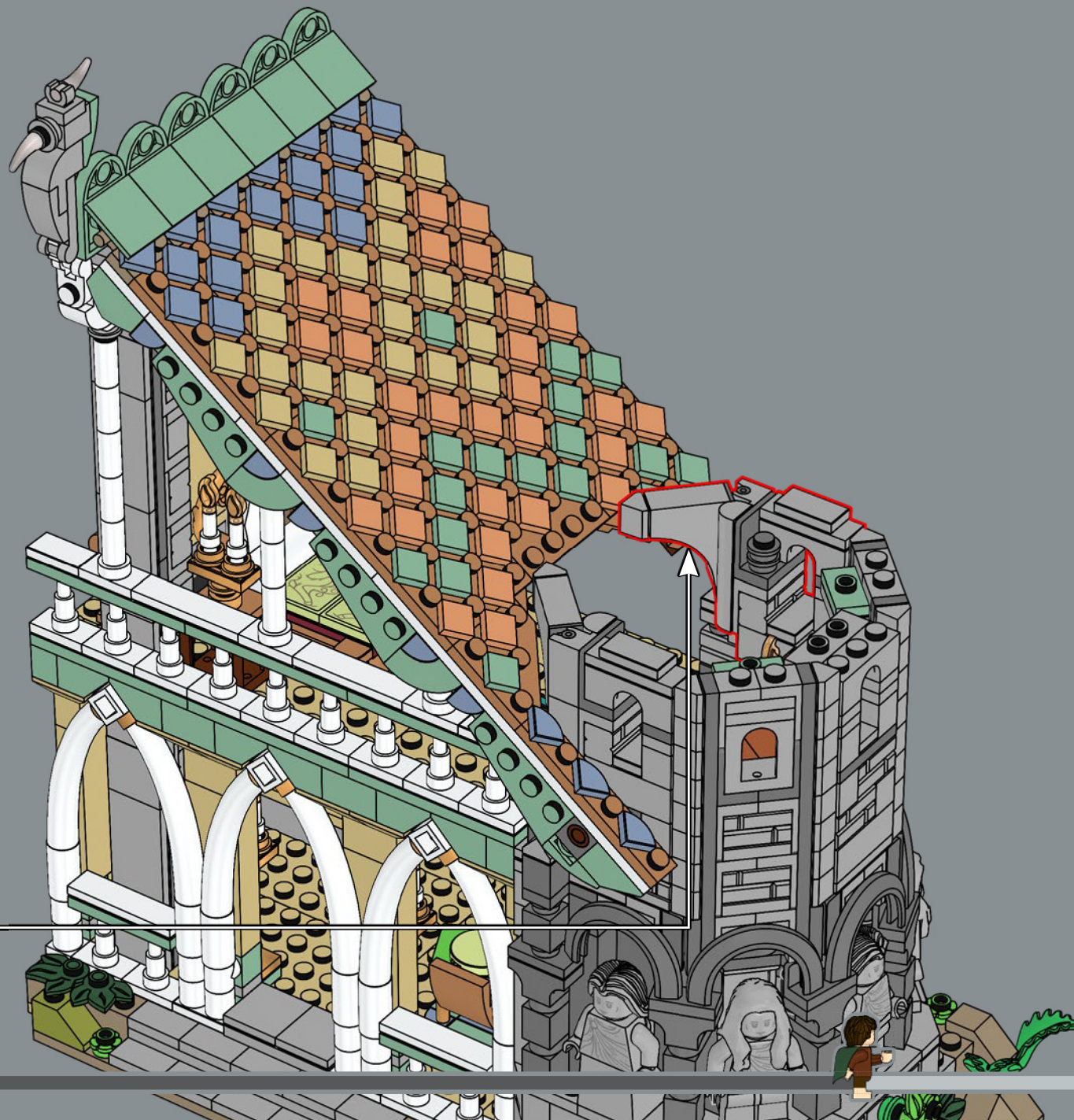

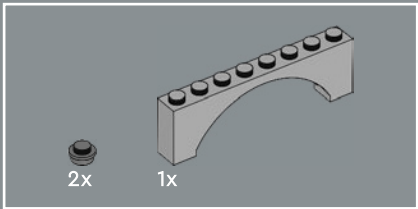

209

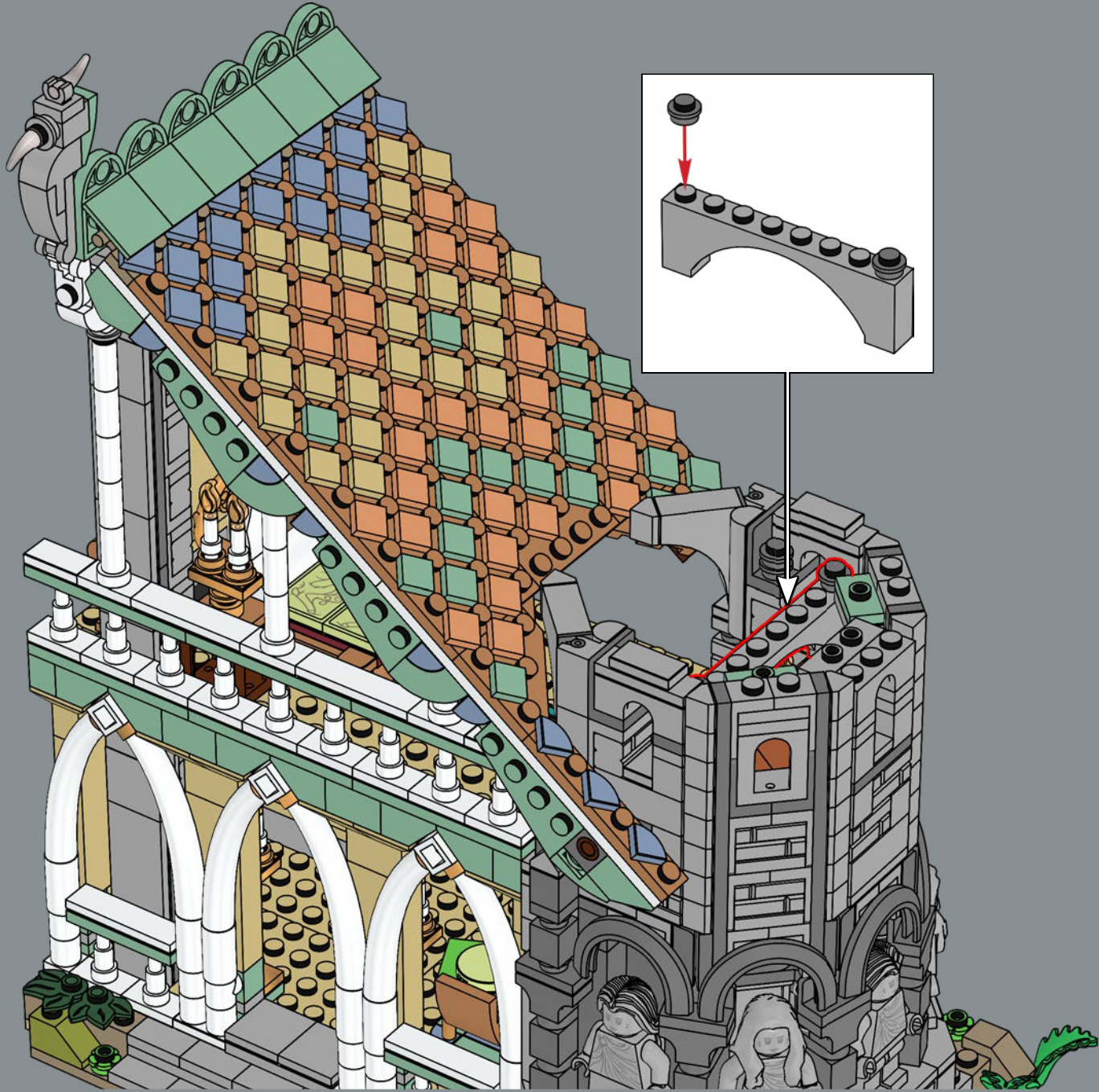

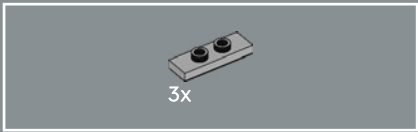

210

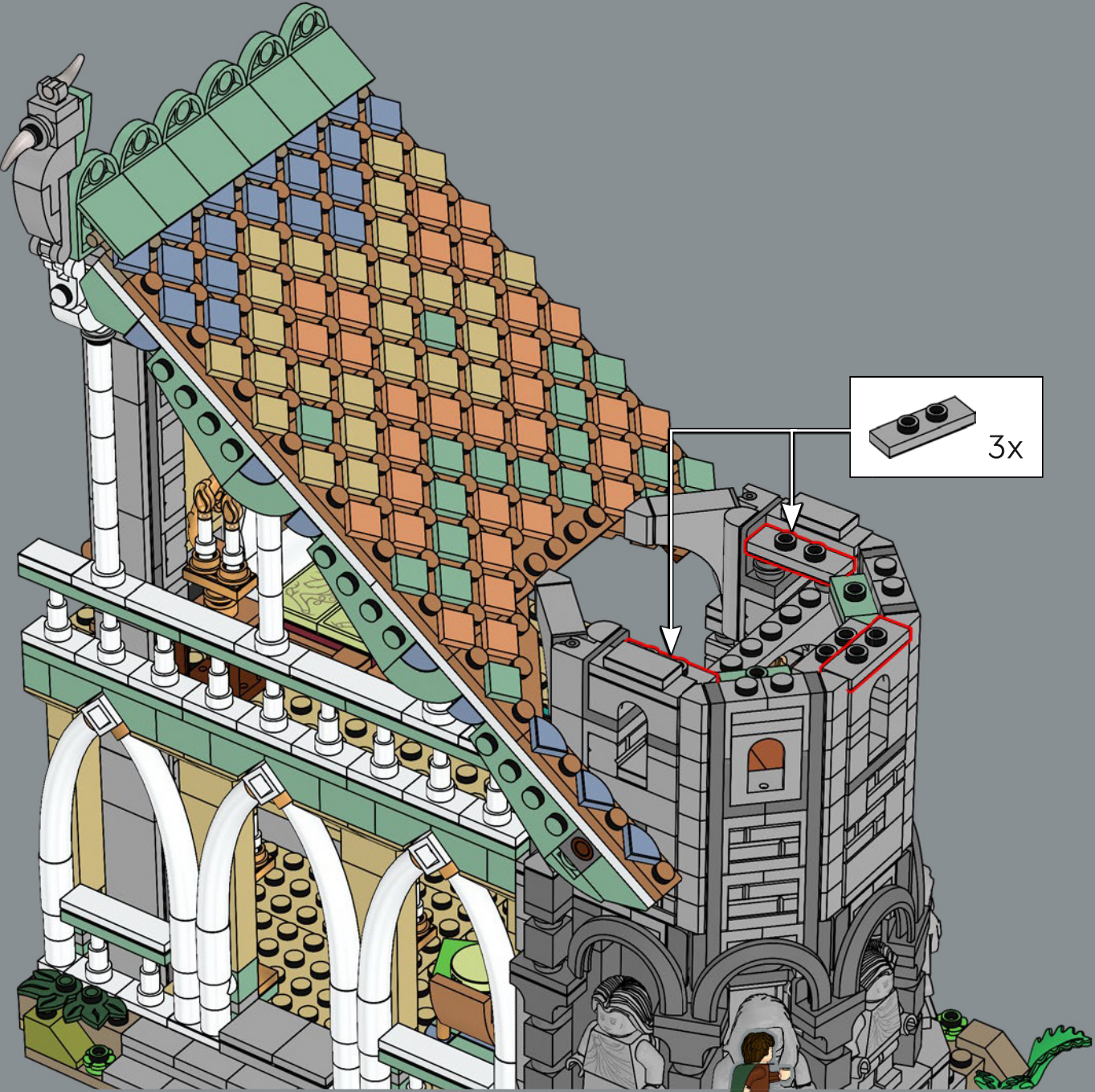



211

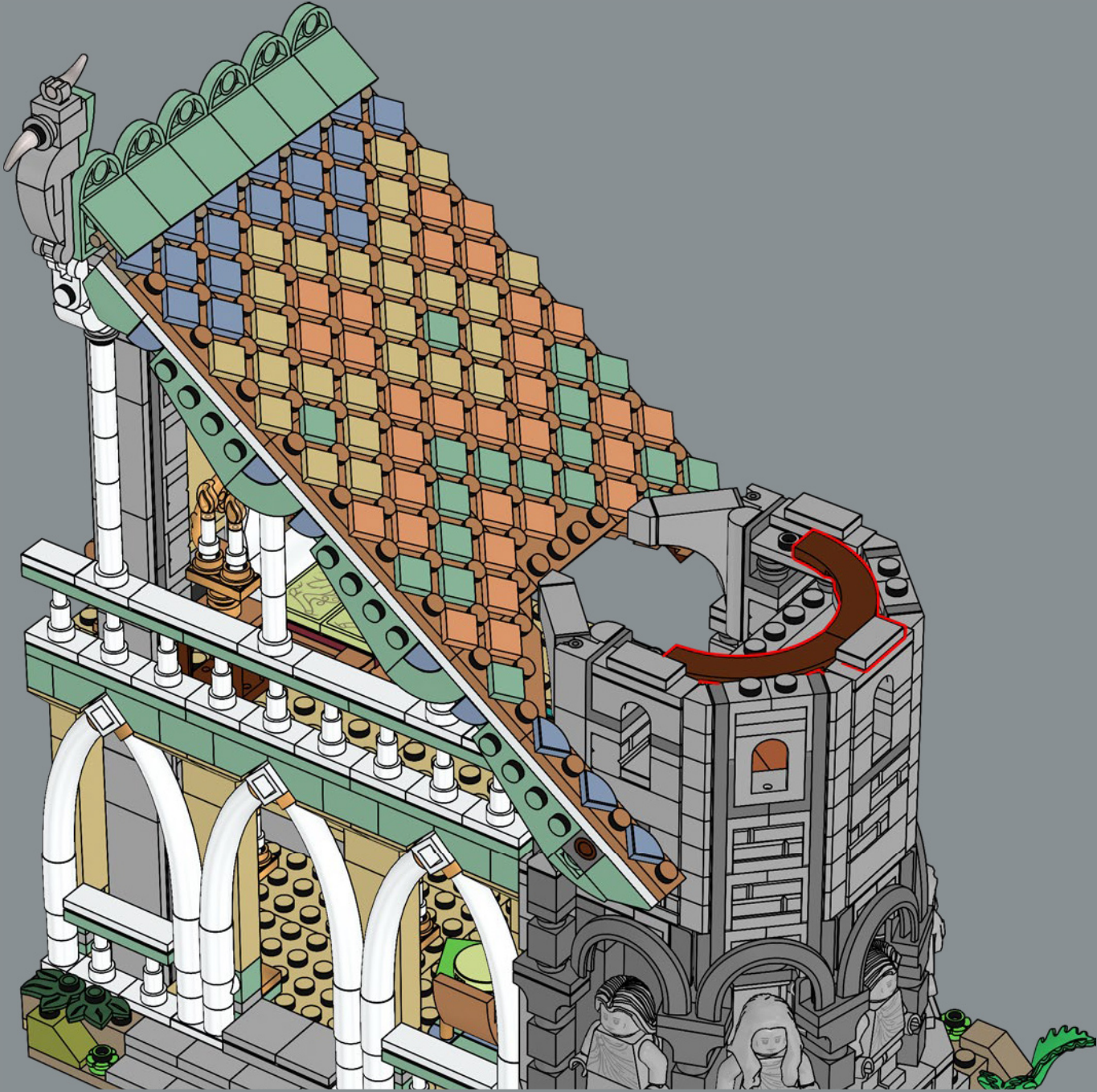

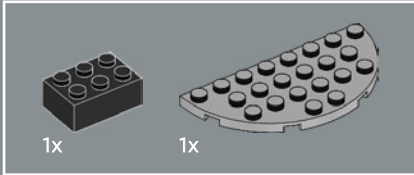
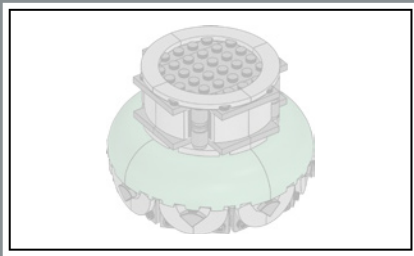

212

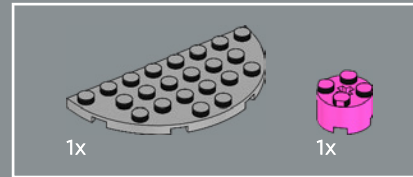
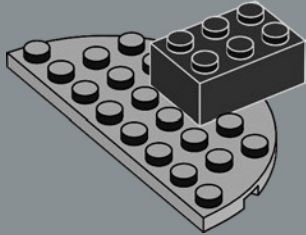

213

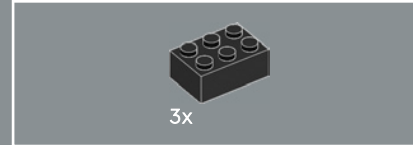
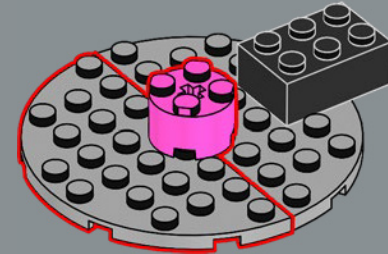

214

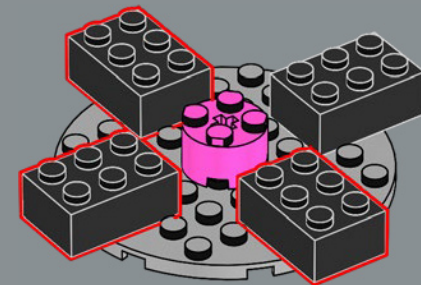

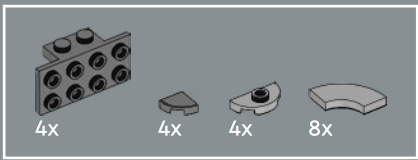

215

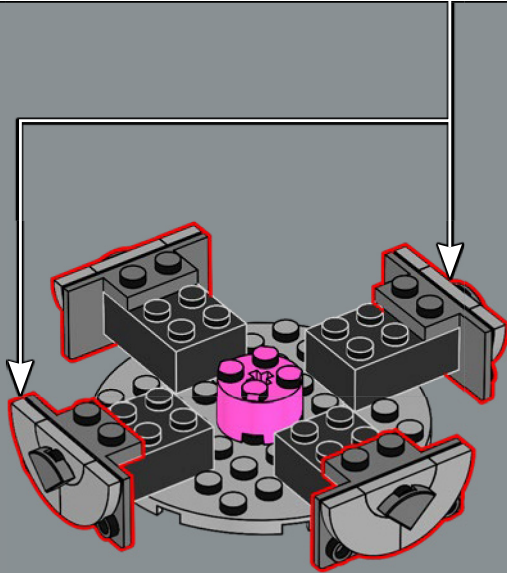
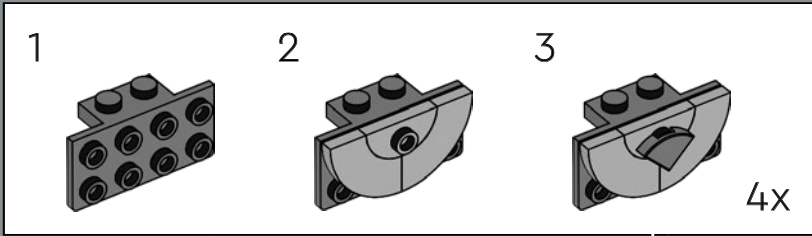

216

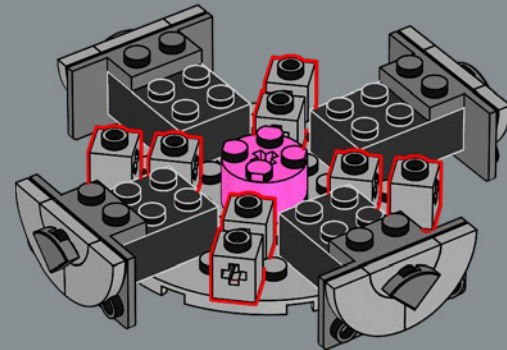

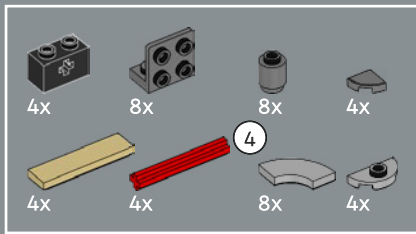

217

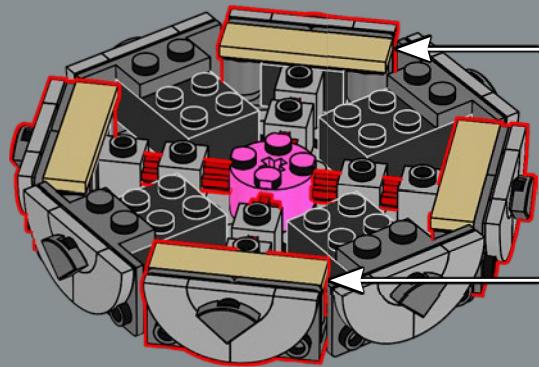
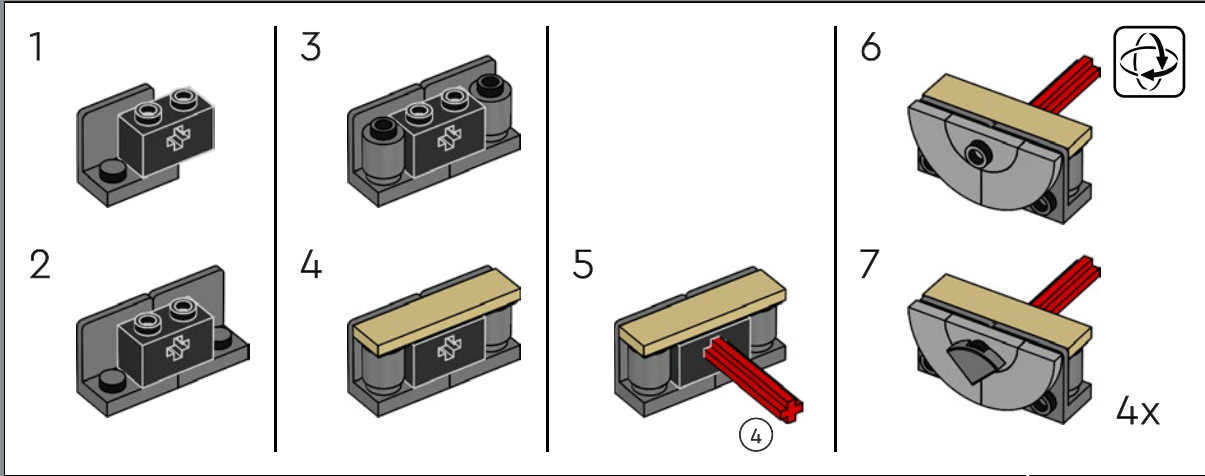

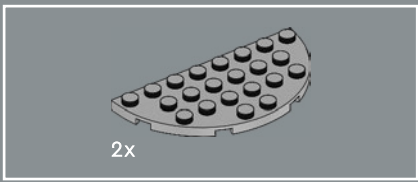

218

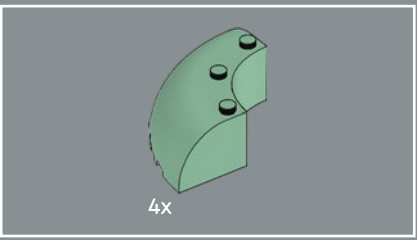
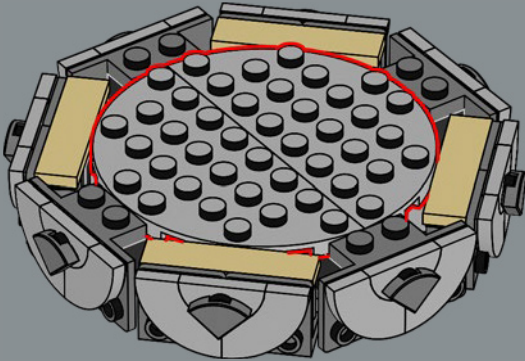

219

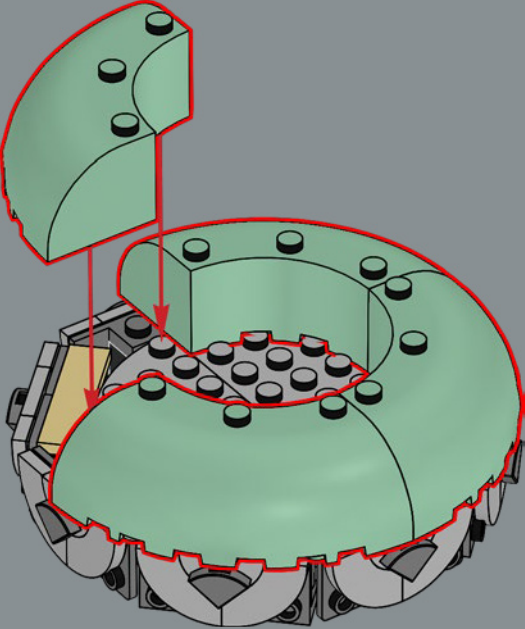

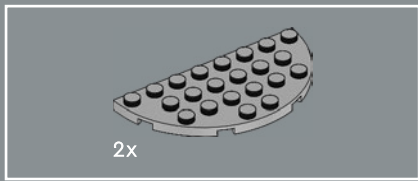

220

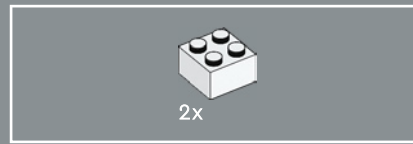
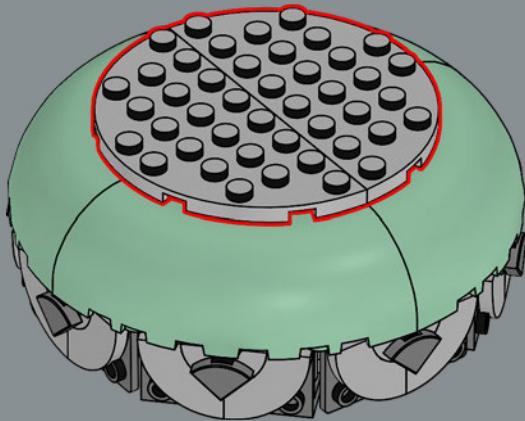

221

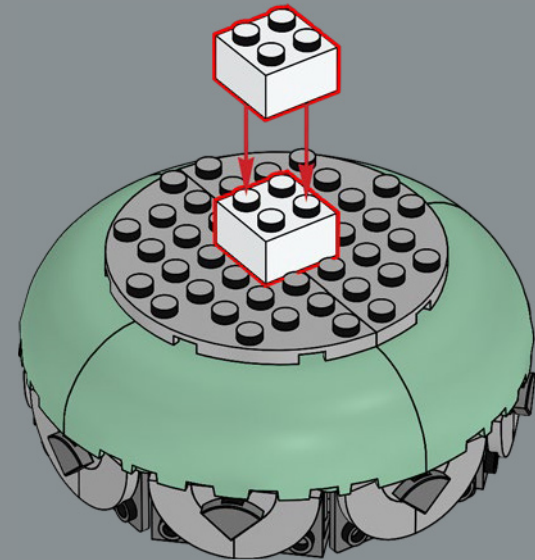

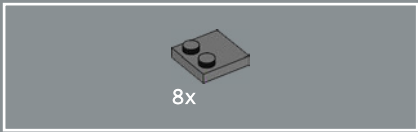

222

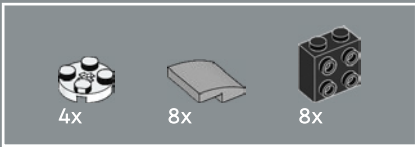
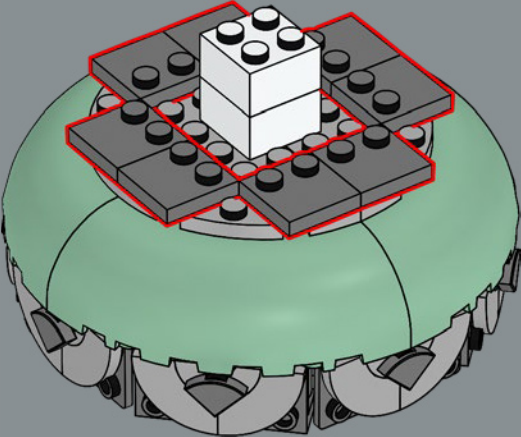

223

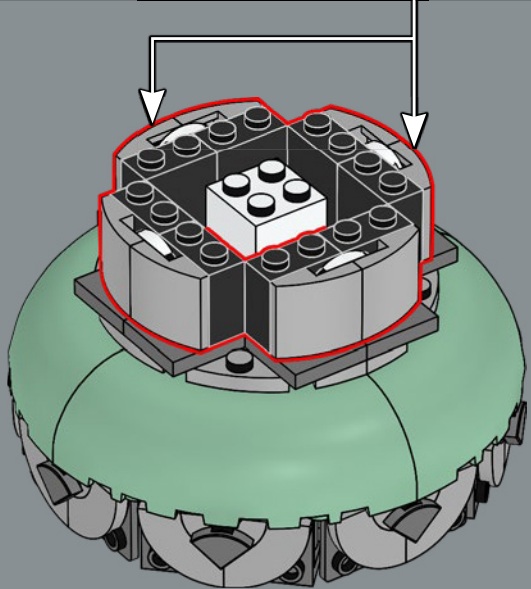
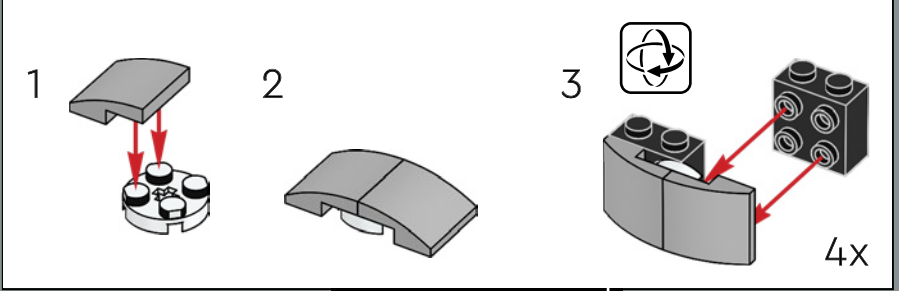

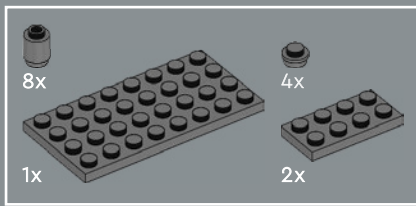

224

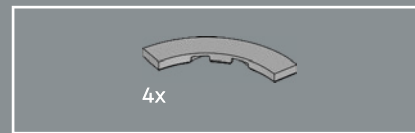
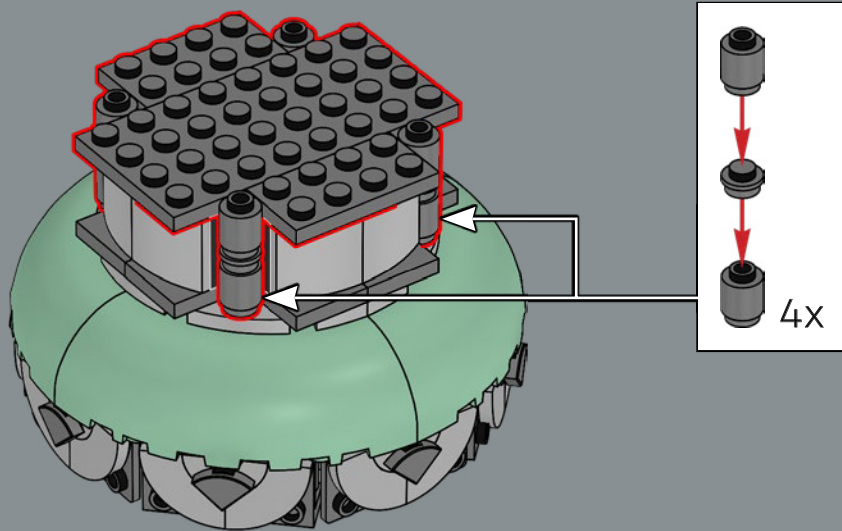

225

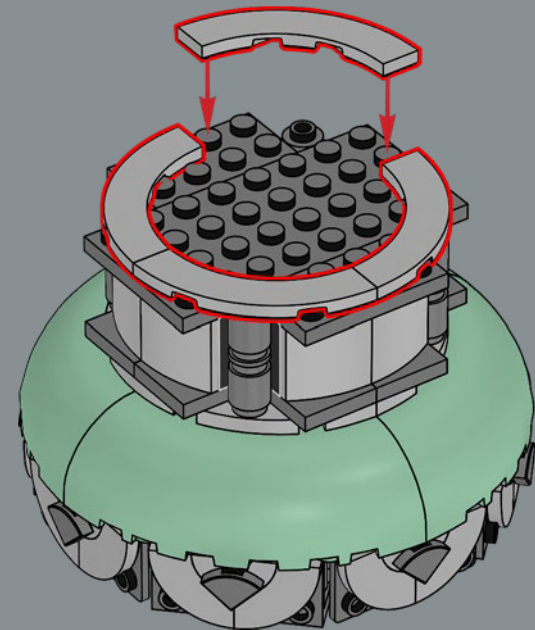



Le toit de la tour est amovible pour vous permettre de suivre l'avancement du livre de Bilbon.

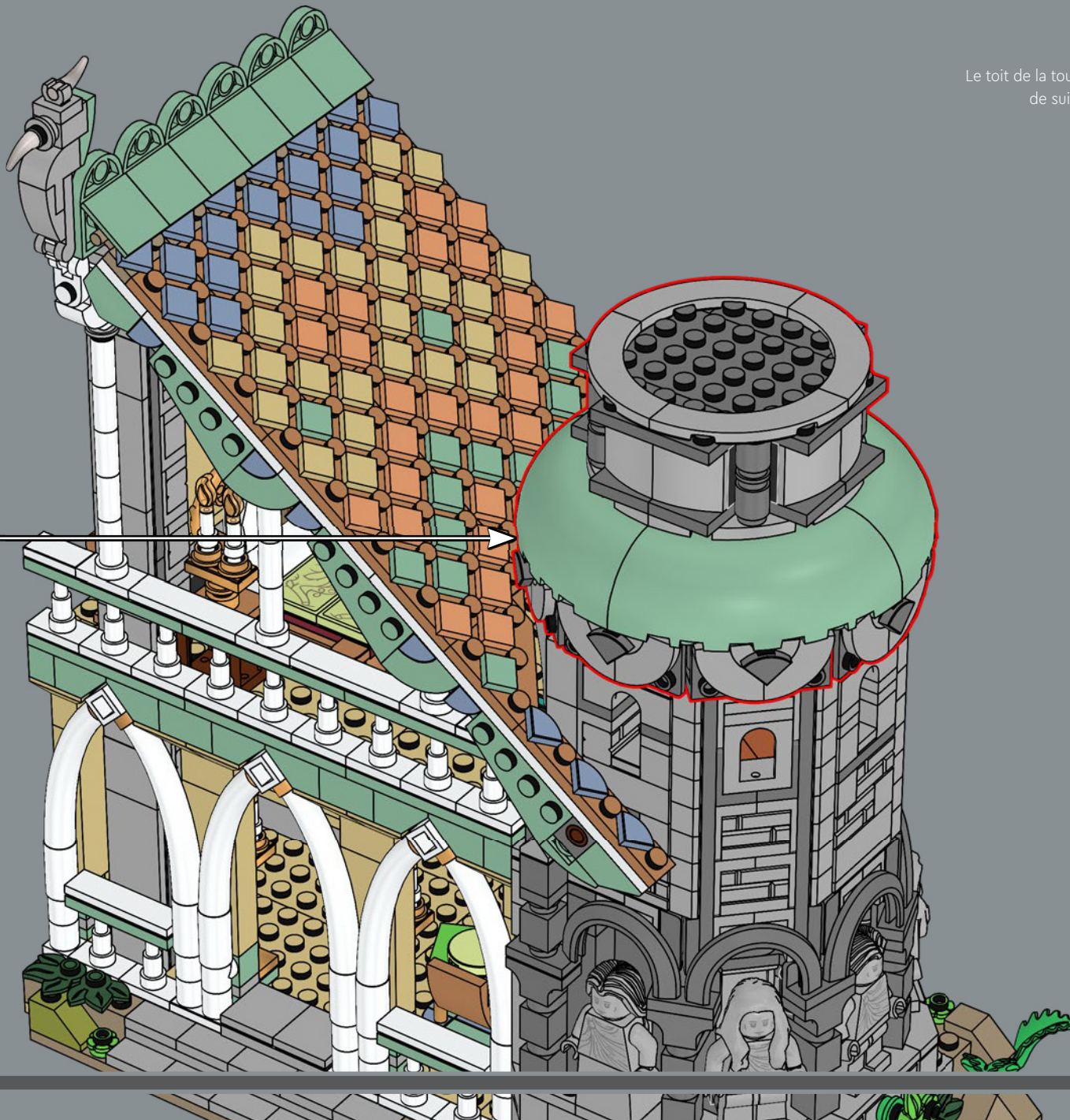



4x

231

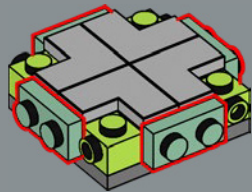

4x



8x



8x



4x

232

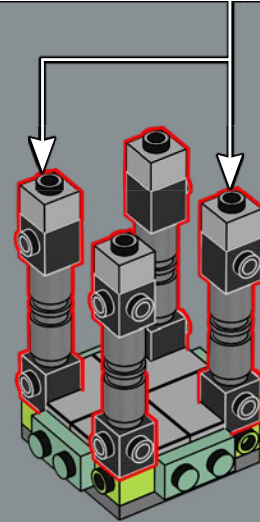
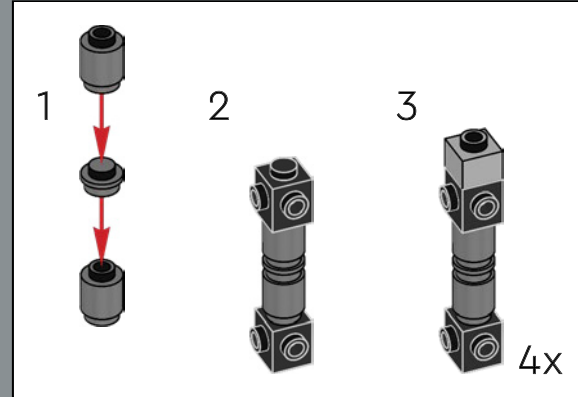

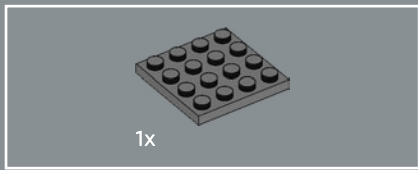

233

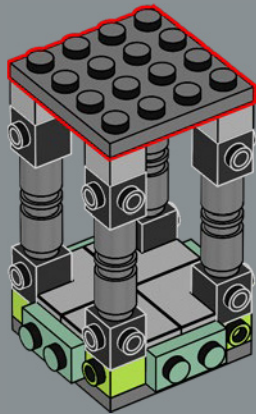

234

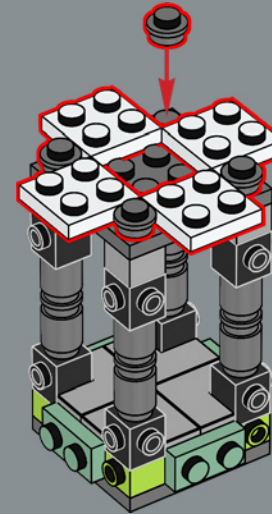

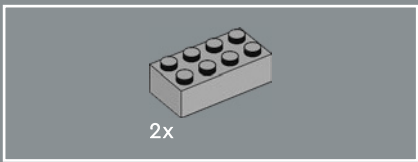

235

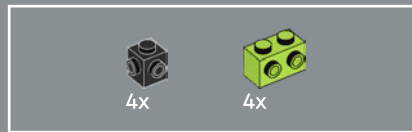
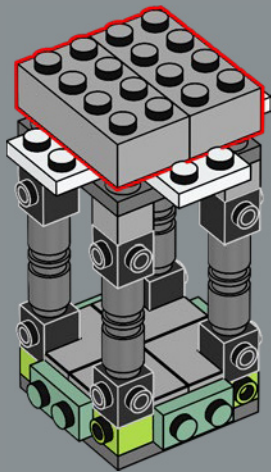

236

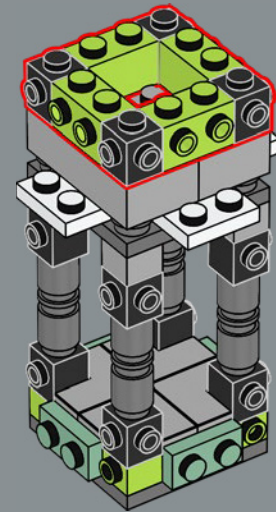

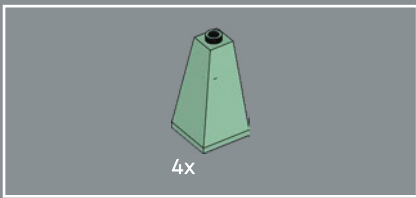

237

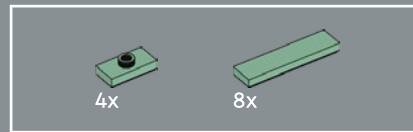
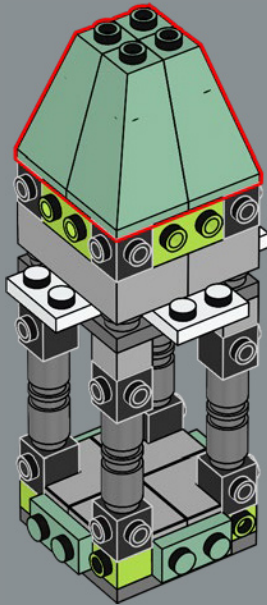

238

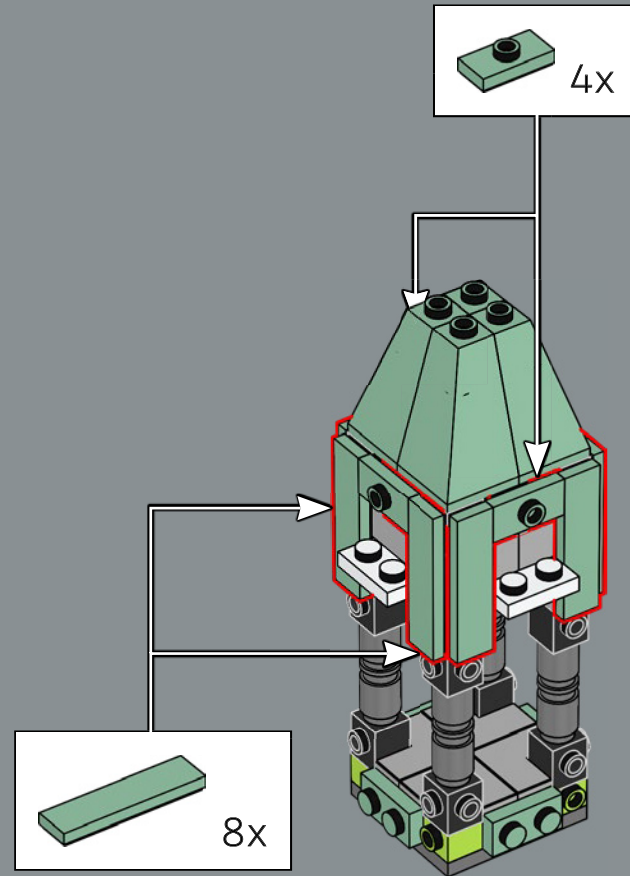

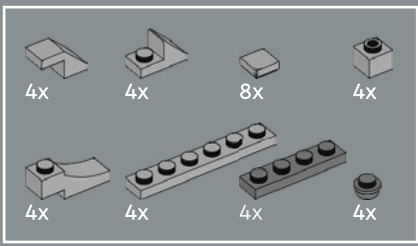

239

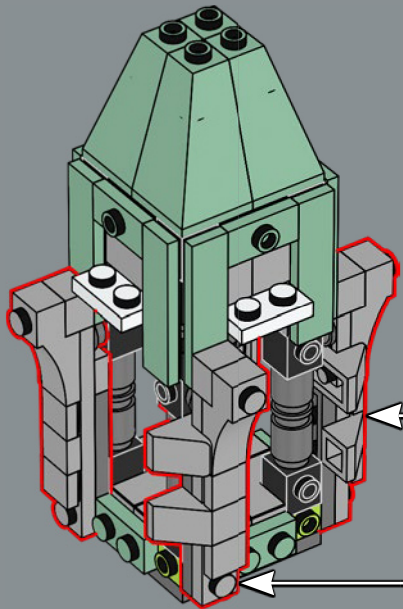
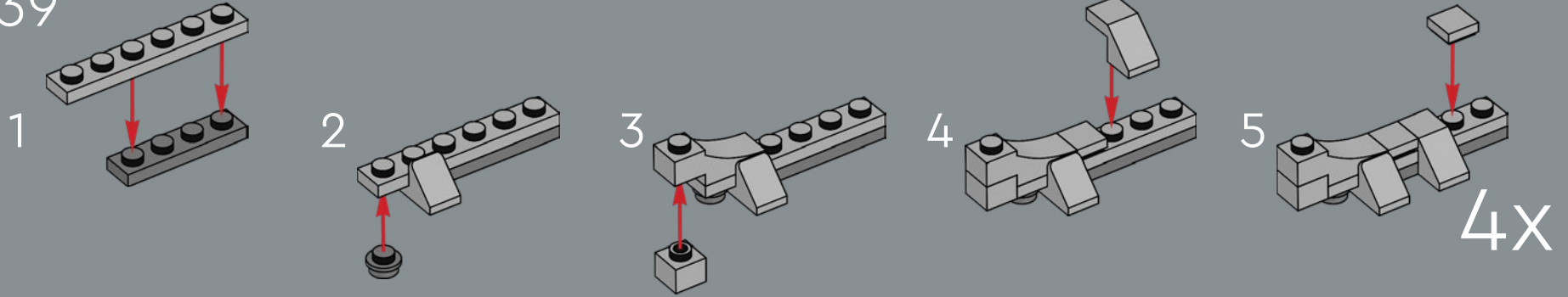

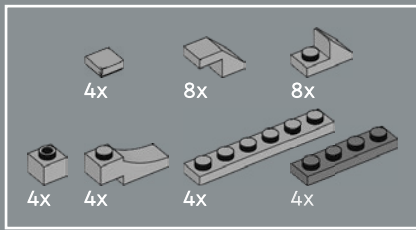

240

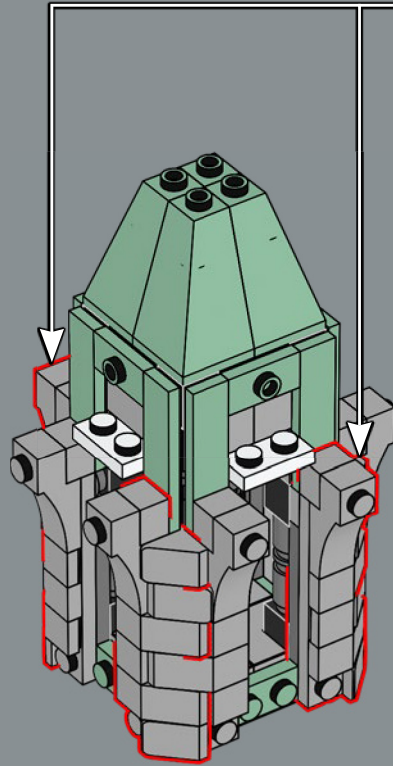
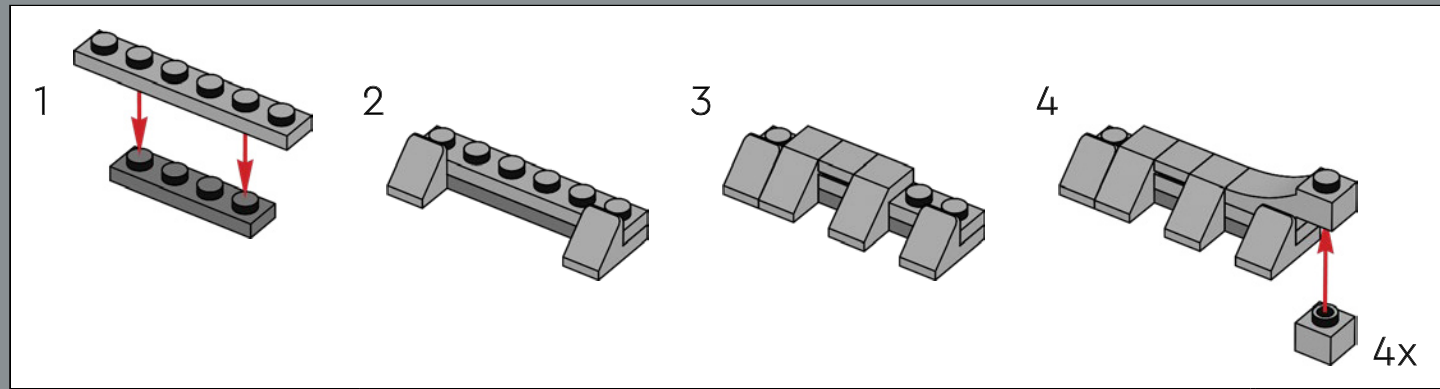



241

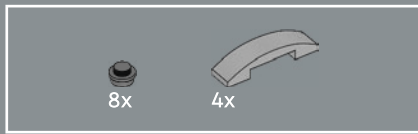
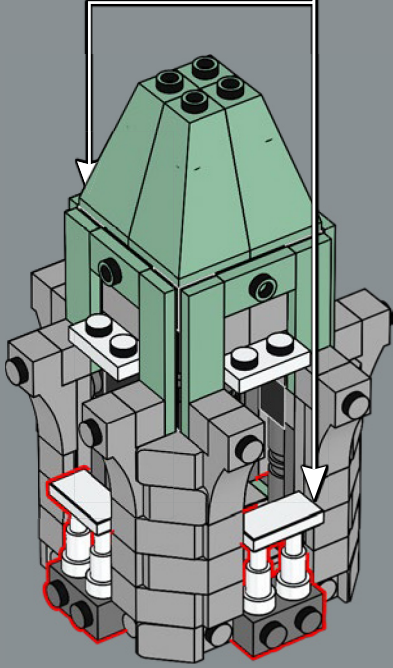
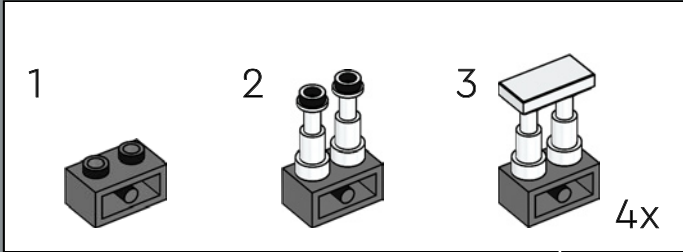

242

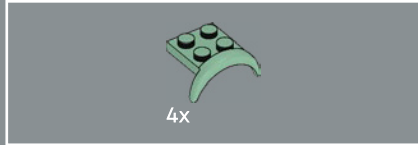
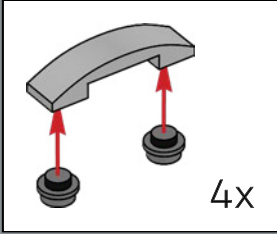

243

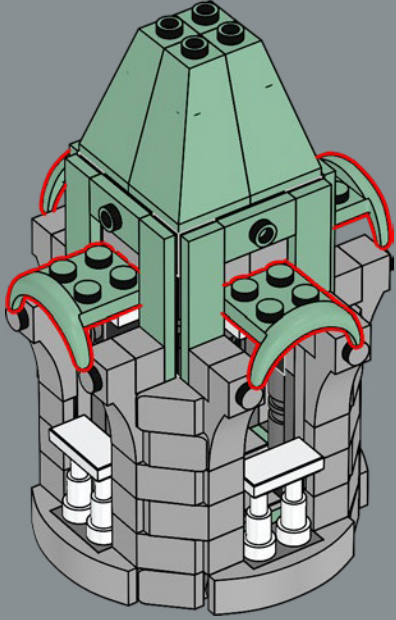
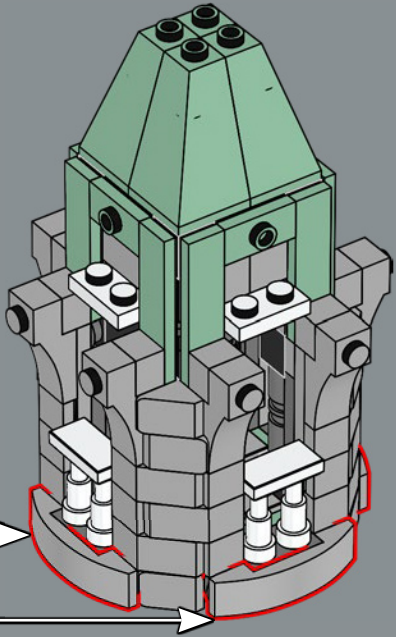

 L'élément vert utilisé au sommet de l'arche des fenêtres était à l'origine un pare-boue de voiture.

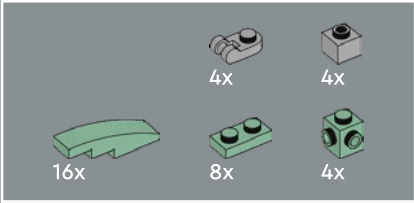

244

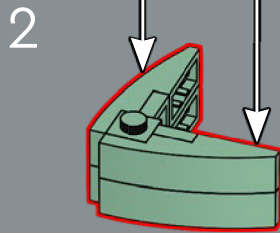
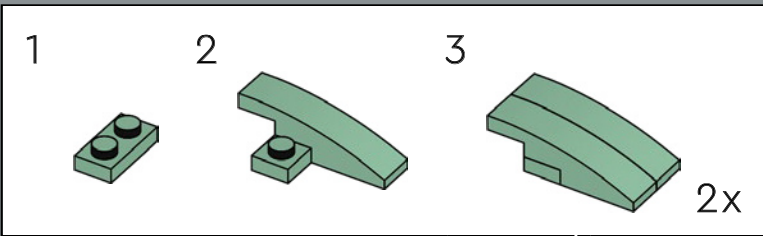
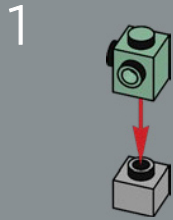

3

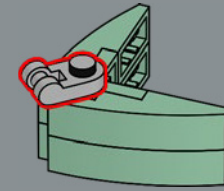

4x

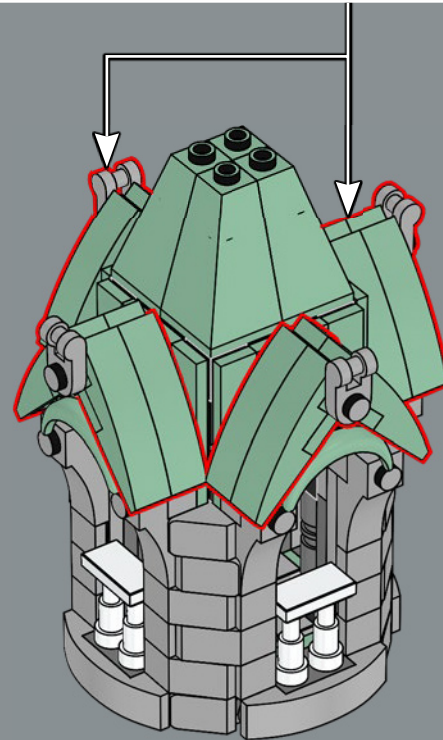



245

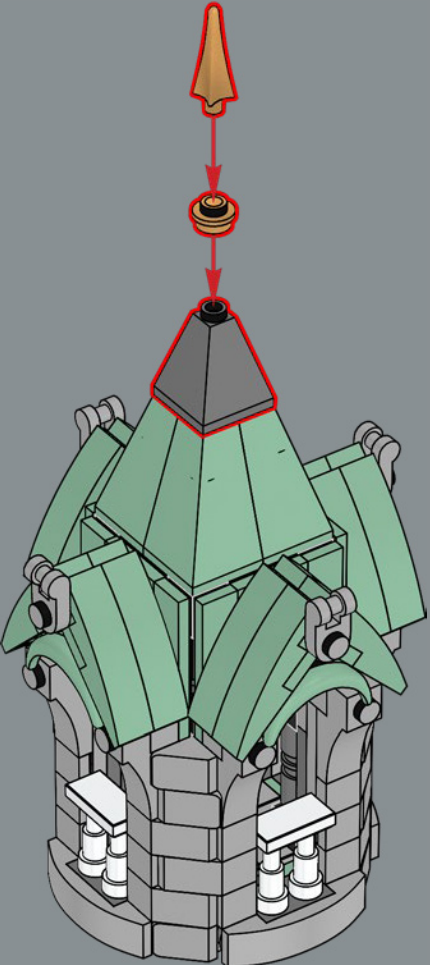

246

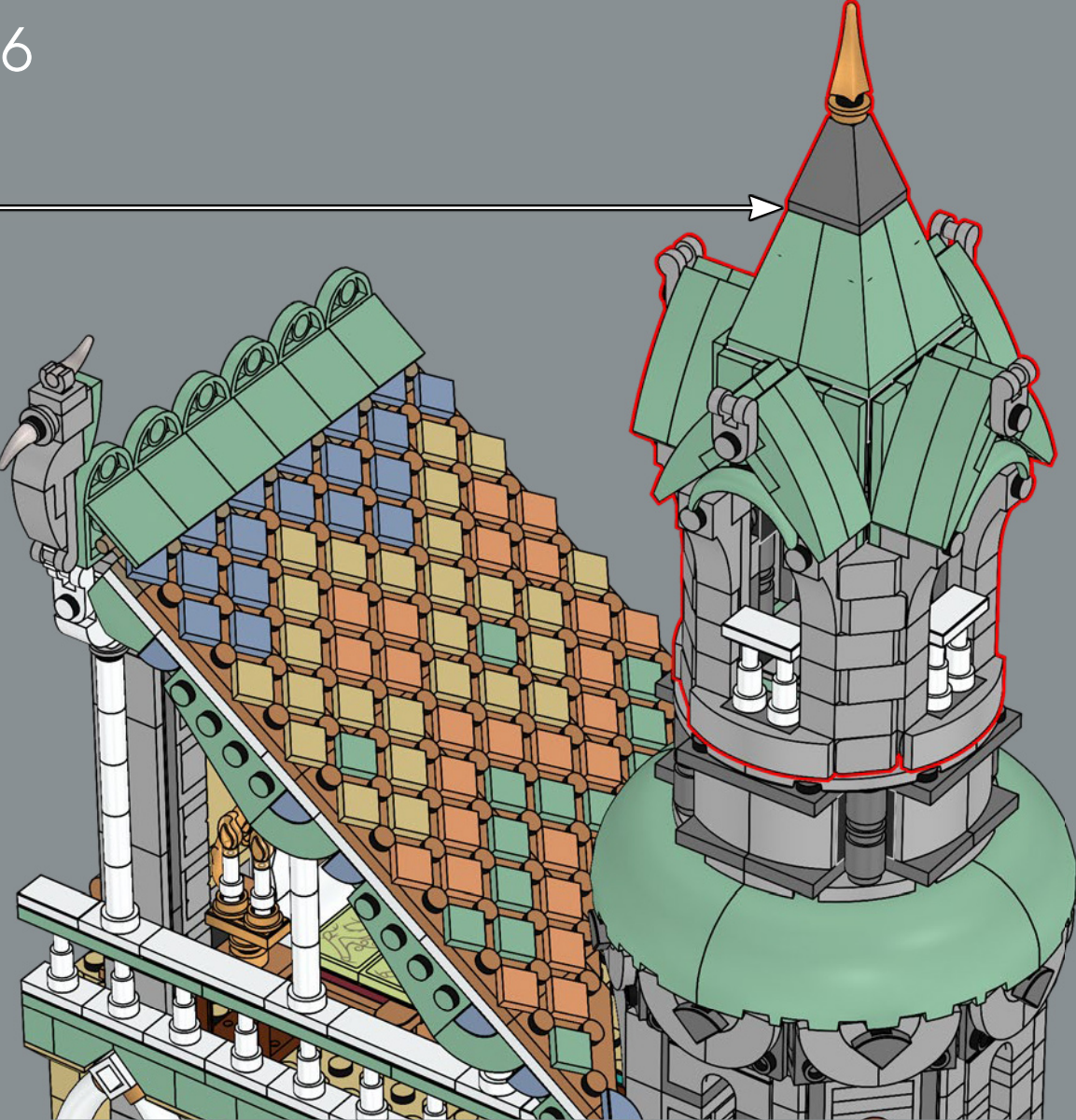

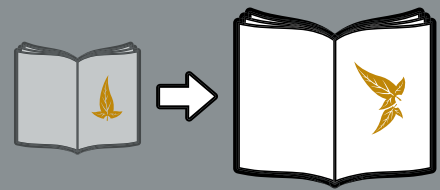

5x
4666579
2x
6145570
1x
6236914

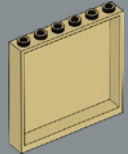

1x
4512688

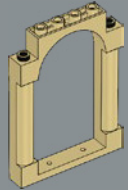

4x
6273864

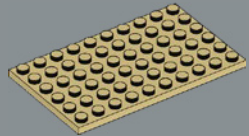

3x
4624185

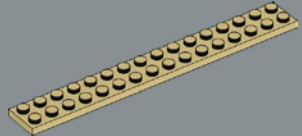

4x
6030980

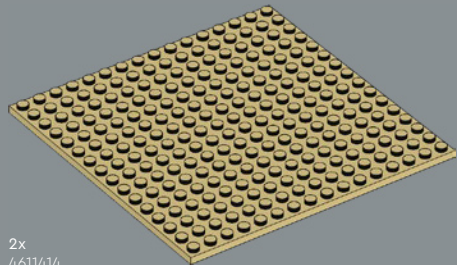

2x
4611414

1x
6310249
1x
6433765



3x
6429962



7x
6421843



1x
306921



2x
6347308



1x
6187620



1x
6001806



1x
6066342



2x
6378120



18x
4142865



1x
6209519



5x
243121



5x
6129995

3x
6330584
130x
6419170
2x
6330418



2x
614323



2x
370023



2x
302323



2x
302123

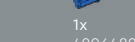

1x
4206482



9x
6299413



4x
300823



1x
235724



2x
362324



1x
302024



2x
300224

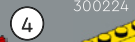

1x
300824

6x
614124
72x
6286830



1x
346024



2x
6130008



2x
4558954



2x
6228987



4x
407026



19x
300226



1x
300926



1x
4181144



9x
6037390



2x
611226



2x
611226



2x
611226

5

1x
4529236
4x
306226
1x
4504382



2x
6265091



4x
6170566



12x
6187572



1x
4214559



8x
473326



20x
6275806



5x
6138173



4x
6178922



1x
6039347



3x
302026



2x
366626



3x
379526

3x
6186675
1x
6335388
1x
6330189



2x
6347310



1x
6338799



3x
6020193



1x
6016172



2x
6250020



2x
6313191



7x
346026



1x
395826



1x
6115117



4x
6401209



1x
6133200



5x
6001494

1x
6168646
40x
614126
1x
474026



2x
6195325



10x
6052126



1x
452826



6x
6371584



6x
6116604



1x
6267045



6x
6168620



2x
6280168



1x
4558209



1x
6115117



4x
6401209



1x
6133200

1x
452226
1x
4189009



1x
6315887



3x
6278152



5x
6279875



8x
6280097



6x
4512363



5x
6390386



2x
6227901



1x
6315573



1x
6283610



1x
4517986



1x
6399780



6x
302128

1x
6299492
1x
6321770
1x
6171101



15x
6229130



2x
6331100



46x
6206150



4x
4119479



15x
6182261



1x
6235080



34x
6411022



16x
6268814



2x
6389695



1x
6406357



5x
6395814



1x
6293826

2x
6266964

4





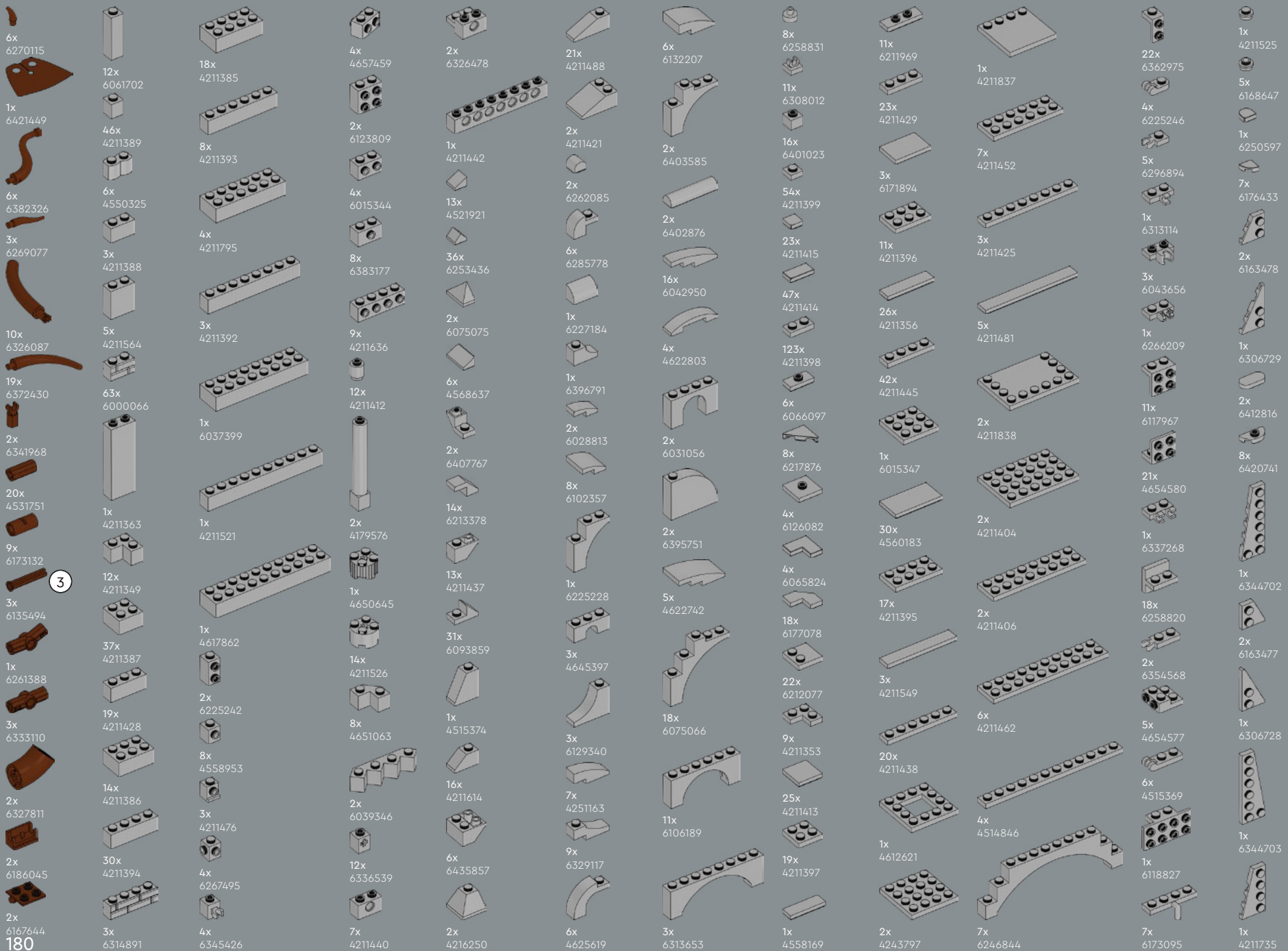

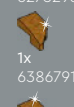
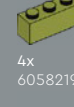
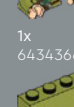
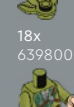
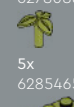
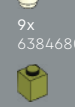
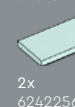
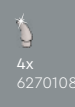
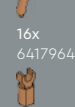
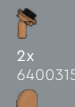
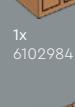
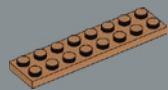
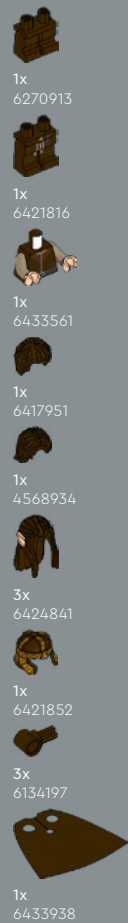

LEGO.com/service



YOU COULD WIN



YOU COULD WIN

Your feedback will help shape the future development of this product series.

Visit:

DU KÖNNTEST GEWINNEN

Dein Feedback trägt zur Weiterentwicklung dieser Produktreihe bei.

Geh auf:

VOUS POURRIEZ GAGNER

Vos commentaires nous aideront à concevoir les futurs produits de cette gamme.

Visitez :

POTRESTI VINCERE TU

La tua opinione ci aiuterà a migliorare la creazione futura di questa linea di prodotti.

Visita:

PUEDES GANAR

Tu opinión contribuirá al futuro de esta serie de productos.

Visita:

轻松获奖

您的反馈将有助于我们在今后改进本产品系列。

请访问:

LEGO.com/productfeedback

You also have the chance to win a LEGO® set.

Terms and conditions apply.*

Außerdem hast du die Chance, ein LEGO® Set zu gewinnen.

Es gelten die Teilnahmebedingungen.*

Vous pourriez également gagner un ensemble LEGO®.

Des conditions s'appliquent.*

Hai anche la possibilità di vincere un set LEGO®.

Termini e condizioni sono applicabili.*

También tienes la oportunidad de ganar un set LEGO®.

Aplican términos y condiciones.*

您还有机会赢取乐高®套装。

条款和条件适用。*

*LEGO.com/productfeedback-terms

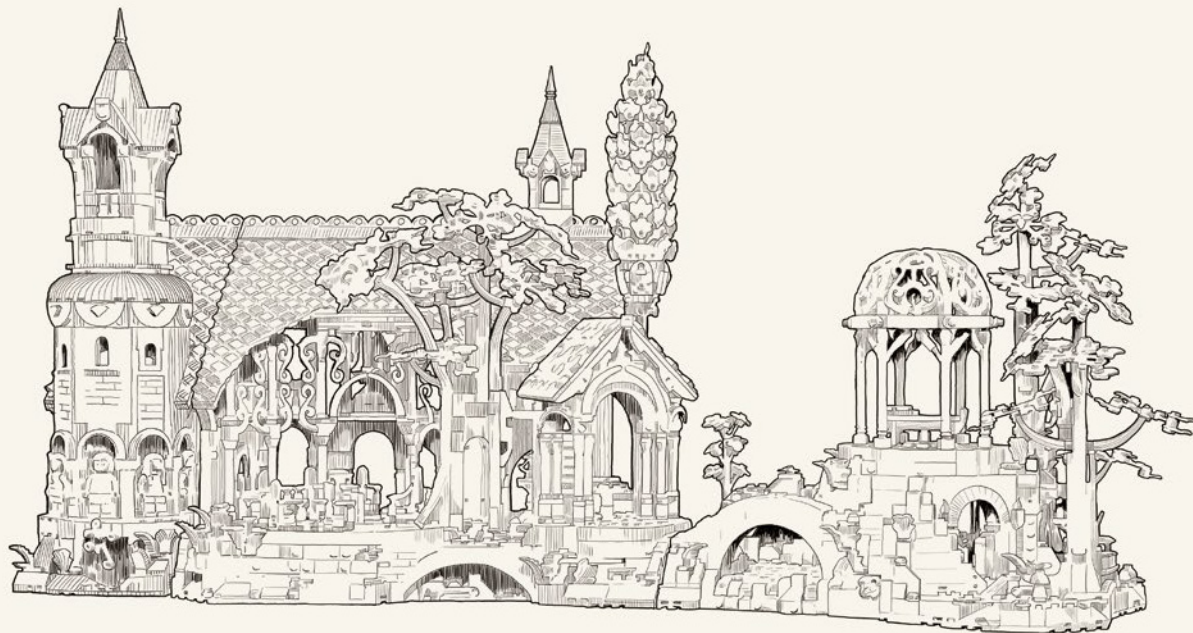

LEGO and the LEGO logo are trademarks of the LEGO Group. ©2023 The LEGO Group.

© 2023 New Line Productions, Inc. All rights reserved. The Lord of the Rings: The Fellowship of the Ring, The Lord of the Rings: The Two Towers, The Lord of the Rings: The Return of the King and the names of the characters, items, events and places therein are trademarks of The Saul Zaentz Company d/b/a Middle-earth Enterprises under license to New Line Productions, Inc. (s23)